



**CATÁLOGO
TARIFA
2022/23**

90

MÁS DE

AÑOS DE HISTORIA SOLO ES EL INICIO

Todo comenzó en los años 30 en un pequeño pueblo del País Vasco, en el norte de España. Fabricábamos ejes para carros y bolas de molino para cementeras. Década tras década, fuimos forjando nuestro carácter creativo lanzando herramientas como la llave ajustable inglesa de moleta lateral, tan utilizada a lo largo de los años.

Hoy mantenemos nuestro compromiso con la mejora continua adaptándonos a las necesidades de los profesionales que aprecian su caja de herramientas.



IRIMO

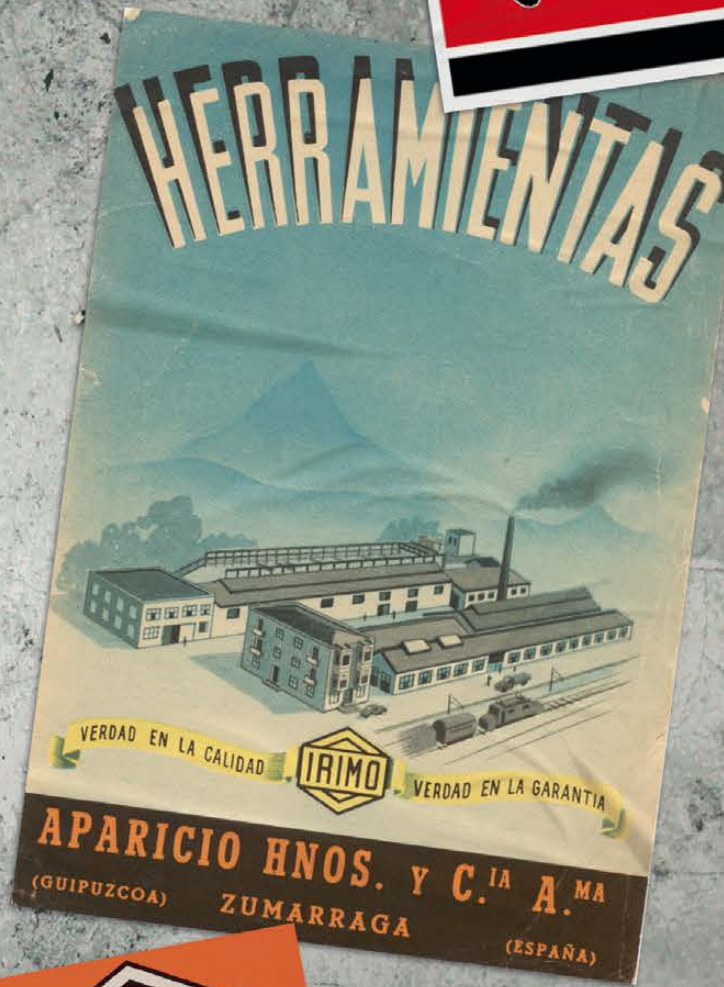

IRIMO

EL ORIGEN ES IMPORTANTE EL DESTINO, AÚN MÁS

QUEREMOS ESTAR DONDE NOS NECESITES.
POR ESO, NUESTRA PRESENCIA ES MAYOR CADA DÍA.



 AUSTRALIA Y NUEVA ZELANDA

 ALEMANIA

 RUSIA

 BÉLGICA

 GRECIA

 ESPAÑA

 CHILE

 ITALIA

 SUECIA

 DINAMARCA

 NORUEGA

 SUIZA

 FINLANDIA

 POLONIA

 PAÍSES BAJOS

 FRANCIA

 PORTUGAL

 TURQUÍA



VISITA NUESTRA WEB

WWW.IRIMO.COM

- TODO LO QUE NECESITAS SABER SOBRE NOSOTROS
- FOTOS EXPLICATIVAS DE PRODUCTO
- INFORMACIÓN COMPLETA DE NUESTROS NUEVOS PRODUCTOS
- DESCARGA CADA HOJA DE PRODUCTO EN PDF
- CONEXIÓN CON REDES SOCIALES
- DÓNDE COMPRAR

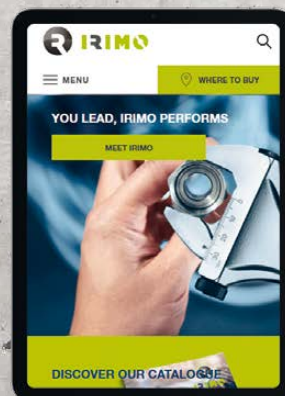
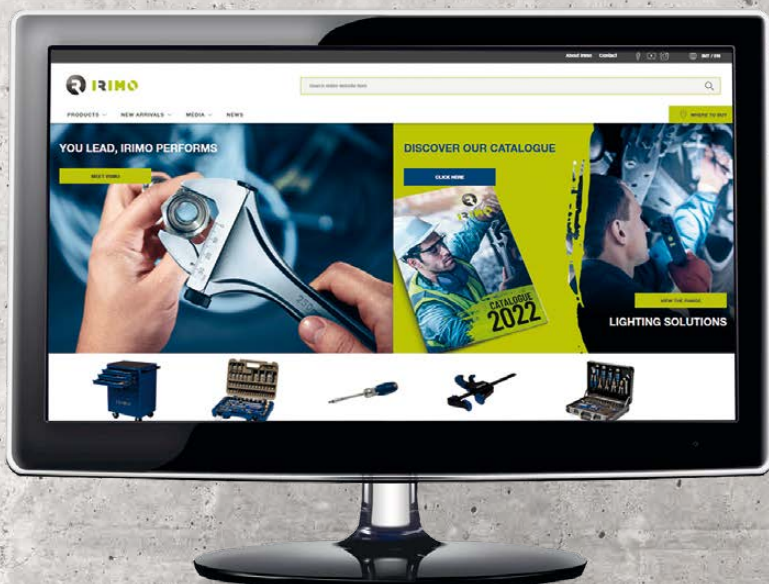

- ➔ **ÍNDICE 9-12**
- ➔ **ÍNDICE ALFANUMÉRICO 194-206**
- ➔ **GARANTÍA 211**
- CONDICIONES DE VENTA 212**

ÍNDICE DE HERRAMIENTAS

1. ALMACENAMIENTO DE HERRAMIENTAS

13



2. LLAVES

35



3. HERRAMIENTAS DINAMOMÉTRICAS

51



4. VASOS Y ACCESORIOS

55



5. TORNILLOS DE BANCO

85



6. HERRAMIENTAS PARA TUBO

93



7. DESTORNILLADORES Y PUNTAS

99



DESTORNILLADORES



PUNTAS



8. HERRAMIENTAS DE GOLPEO

133



10. HERRAMIENTAS DE EXTRACCIÓN

163



11. HERRAMIENTAS DE CORTE Y MEDICIÓN

169



HERRAMIENTAS DE CORTE



MEDICIÓN



9. ALICATES - TIJERAS Y CUCHILLOS

145



ALICATES



TIJERAS Y CUCHILLOS



12. ILUMINACIÓN Y HERRAMIENTAS NEUMÁTICAS Y A BATERÍA

183





A

Accesorios 1/4"	58
Accesorios 3/8"	62
Accesorios 1/2"	67
Accesorios 3/4"	75
Accesorios Impacto 3/8"	78
Accesorios Impacto 1/2"	80
Accesorios Impacto 3/4"	81
Accesorios Impacto 1"	83
Adaptador Puntas 3/8"	63
Adaptador Puntas 1/2"	70
Ajustables	36
Alicate Pelacables	149
Alicates (1000V)	151
Alicates Arandelas	155
Alicates para Terminales Aislados	150
Aprietos	90
Arco Tronzador	170
Arcos para Metales	171
Atornillador a Batería	189

Calibres	179
Carraca 1/4"	58
Carraca 3/8"	62
Carraca 1/2"	67
Carraca 3/4"	75
Carraca Neumática	188
Carros	14
Carro con Cajas Apilables	24
Carro Dos Bandejas	25
Cinta Métrica	177
Cofre 4 Cajones	14
Corta Cables	149
Cortafríos	134
Cortatubos	96
Cortatubos de Plástico Auto-retráctil	96
Cortavarillas	154
Cuchillo Electricista	161
Cuchillo Multiusos con Funda	161
Cutters	160

B

Banco de Trabajo Plegable	26
Barras para Desencofrador	138
Bolsa para Transporte Herramienta	30
Botadores	134
Buriles	134
Buscapolos	111

C

Cabeza Intercambiable Dinamométrica	52
Caja Herramientas de Plástico	29
Caja Metálica	26

D

Destornilladores	100
Destornilladores Aislados (1000V)	104
Destornilladores de Carraca	103
Destornillador Mango T	108
Destornilladores Precisión	111
Destorgolpe 5/16"	129
Destornillador Reversible	110
Destornilladores Stecker	103
Dinamométricas	52
Destornillador Portapuntas Carraca	103

E

Escuadras	178
Espátulas Carrocero	180
Espátulas Pintor	180
Estuches Porta-herramientas	32
Expositores Destornilladores	107
Extractores	164
Extractor Espárragos	166
Extractor Magnético	167

F

Filtros	189
Flexómetros	176
Foams para Carros	18
Formones	144

G

Galgas	178
Granetes	135
Grapadoras	181
Grips	156

H

Hoja Bimetal	171
Hojas de Tronzar	170

I

Iluminación	184
-------------	-----

J

Juego Alicates (1000V)	152
Juego Alicates para Engastar con Mordazas Intercambiables	151

Juego Botadores	136
Juego Coronas	172
Juego Destorgolpe	129
Juego Destornilladores	105
Juego Destornilladores (1000V)	108
Juego Espátulas Carrocero	180
Juego Formones	144
Juego Ganchos	162
Juego Granetes	135
Juego Gubias para Talla	144
Juego Limas	173
Juego Llaves Ajustables Inglesas	37
Juego Llaves Combinadas	40
Juego Llaves Combinadas con Carraca	41
Juego Llaves Estrella	44
Juego Llaves Fijas	38
Juego Llaves Pipa Abiertas	46
Juego Llaves Tubo	47
Juego Mordazas Grip	158
Juego Palancas	168
Juego Puntas Tablets 4 mm	127
Juego Puntas 1/4"	126
Juego Puntas 10 mm	132
Juego Remachadora Manual	159
Juego Sacabocados	97
Juego Terminales Aislados y Conectores de Enchufe	151
Juego Vasos 1/4"	60
Juego Vasos 3/8"	63
Juego Vasos 1/2"	70
Juego Vasos 3/4"	76
Juego Vasos Impacto 1/2"	79
Juego Vasos Impacto 3/4"	81
Juego Vasos Impacto 1"	82

L

Lámparas de Bolsillo	184
Lámparas de Inspección	185
Lámparas de Trabajo	186
Lámparas Frontales	186
Limas	172
Linterna de Aluminio	185
Lubricadores	188
Llave Cadena	95
Llaves Acodadas	112
Llaves Ajustables Inglesas	36
Llaves Combinadas	39
Llaves con Carraca	41
Llaves de Gancho	49
Llaves de Golpe	48
Llaves Dinamométricas	52
Llaves Estrella Plana	44
Llaves Fijas	37
Llaves Tipo Allen	112
Llaves Tipo Allen Serie Larga	113
Llaves Impacto	187
Llaves Pipa	46
Llaves Stillson	94
Llaves Tubo Mod. Sueco	95
Llaves Tubulares	47
Llaves Universales	49

M

Maceta Albañil	142
Magnetizador/Desmagnetizador	110
Martillo Antirrebote	143
Martillo Boca Nylon	143
Martillos	139
Material de Punto de Venta	191

Maza Goma	142
Mini Alicates	148
Mini Arco	172
Mini Cortatubos	96
Mochilas Porta-herramientas	31
Mordazas Ajuste Rápido	91
Mordazas Grip	156
Multiherramientas	161

N

Neumática	187
Niveles	174

P

Palanca	167
Pelacables (1000V)	153
Perforadores Chapa	168
Pistola de Cola Termofusible	180
Pistola de Silicona	180
Pistolas Impacto	187
Pistola de Calor	181
Porta Herramientas	30
Portapuntas Magnético 1/4"	102
Punta 10 mm	130
Punta Trazadora	138
Puntas 1/4"	119
Puntas 5/16"	128

R

Rasquetas	160
Regulador	189
Remachadoras	159
Repuestos de Tornillos Banco	87
Revólver Sacabocados	97

S

Sacabocados	97
Sargentos	90
Serruchos	170
Sopladora	188
Stillson	94

T

Tenacilla (1000V)	153
Tenaza Ajuste Rápido	147
Tenaza Carpintero	153
Tenaza Rusa	153
Termómetro Infrarrojos	179
Tijeras Cortachapas	156
Tijeras Electricista	162
Tornillos Banco	86
Tornillos Banco Sobremesa	89
Transportador	25
Trazador	138
Tronzatuercas	166

V

Vasos 1/4"	56
Vasos 3/8"	61
Vasos 1/2"	64
Vasos 3/4"	74
Vasos con Punta 1/4"	57
Vasos con Punta 1/2"	66
Vasos Impacto 3/8"	77
Vasos Impacto 1/2"	79
Vasos Impacto 3/4"	81
Vasos Impacto 1"	82
Volvedor	166







01. ALMACENAMIENTO DE HERRAMIENTAS





CARROS

CARRO DE 5 CAJONES



CARRO DE 6 CAJONES



CARRO DE 7 CAJONES



- Carro 5 cajones robusto
 - Dimensiones interiores de los cajones:
 - (1 x) 543 x 445 x 50 mm
 - (2 x) 543 x 445 x 116 mm
 - (2 x) 543 x 445 x 182 mm
 - Gran capacidad
 - Chasis doble pared que protege los laterales para no dañar los cajones ante golpes
 - Reforzado en sitios claves para evitar puntos débiles
 - Guías de rodamientos de bolas en los cajones con 100% de apertura
 - Sistema 'click' de apertura y cierre de cajones
 - Sistema de cierre seguro y robusto
 - Ruedas de 125 x 30 mm con rodamientos de bola y goma que no marca:
 - 2 fijas y 2 giratorias con freno
- Carro 6 cajones robusto
 - Dimensiones interiores de los cajones:
 - (3 x) 543 x 445 x 50 mm
 - (2 x) 543 x 445 x 116 mm
 - (1 x) 543 x 445 x 246 mm
- Carro 7 cajones robusto
 - Dimensiones interiores de los cajones:
 - (5 x) 543 x 445 x 50 mm
 - (1 x) 543 x 445 x 116 mm
 - (1 x) 543 x 445 x 246 mm

R									€
9066K5	1	677 x 501 x 954	400	543 x 445 x h	25	125 x 30	48	775,16	
9066K6	1	677 x 501 x 954	400	543 x 445 x h	25	125 x 30	51	805,82	
9066K7	1	677 x 501 x 954	400	543 x 445 x h	25	125 x 30	52	831,94	

COFRE DE 4 CAJONES



REPUESTOS

		€
9066K-01	Guías (2x) - 30 kg de capacidad	18,30
9066K-02	Dos ruedas giratorias de 125 x 30 mm	28,81
9066K-03	Dos ruedas fijas de 125 x 30 mm	23,91
9066K-05	Asa lateral para serie 9066K	27,55
9066K-06	Encimera de goma	13,31
9064-15	Asas laterales para cofre	18,40
9064AC01	Set 7 alfombrillas protectoras para los cajones	17,76

- Cofre 4 cajones robusto
- Gran capacidad
- Chasis doble pared que protege los laterales para no dañar los cajones ante golpes
- Reforzado en sitios claves para evitar puntos débiles
- Guías de rodamientos de bolas en los cajones con 100% de apertura
- Sistema 'click' de apertura y cierre de cajones
- Sistema de cierre seguro y robusto
- Dimensiones interiores de los cajones:
 - (3 x) 543 x 445 x 50 mm
 - (1 x) 543 x 445 x 116 mm

R								€
9065K4	1	677 x 501 x 420	250	543 x 445 x h	25	38	570,22	

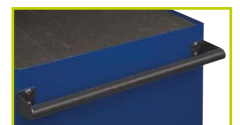



CARRO DE 6 CAJONES CON FOAMS Y HERRAMIENTAS, 206 piezas



IFF1A001



IFF1A002



IFF1A003

9066K6FF100	1	677 x 501 x 954	80	1.199,36 €

IFF1A001

045001, 045011, 045021	
101-04-1, 101-045-1, 101-05-1, 101-055-1, 101-06-1, 101-07-1, 101-08-1, 101-09-1, 101-10-1, 101-11-1, 101-12-1, 101-13-1, 101-14-1	
103-04-1, 103-05-1, 103-06-1, 103-07-1, 103-08-1, 103-09-1, 103-10-1, 103-11-1, 103-12-1, 103-13-1	
105-22-1, 105-24-1	
105-40-1	
105-42-1	
105-48-1	
105-50-1	
105-70-1	
106-04-1, 106-05-1, 106-06-1, 106-07-1, 106-08-1	
121-10-1, 121-11-1, 121-12-1, 121-13-1, 121-14-1, 121-15-1, 121-16-1, 121-17-1, 121-18-1, 121-19-1, 121-20-1, 121-21-1, 121-22-1, 121-24-1, 121-27-1, 121-30-1, 121-32-1	
125-23-1, 125-25-1	
125-40-1	
125-42-1	
125-48-1	
125-53-1, 125-54-1	
124-14-1, 124-15-1, 124-17-1, 124-19-1, 124-22-1	
125-70-1	
126-10-1, 126-11-1, 126-12-1, 126-14-1, 126-16-1, 126-18-1, 126-20-1, 126-24-1	
475-4-1, 475-5.5-1, 475-6.5-1	
475-H3-1, 475-H4-1, 475-H5-1, 475-H6-1	
475-PH1-1, 475-PH2-1	
475-PZ1-1, 475-PZ2-1	
475-T8-1, 475-T10-1, 475-T15-1, 475-T20-1, 475-T25-1, 475-T27-1, 475-T30-1	

IFF1A002

529171	
475-61-1	
48-9-H	
511-105-1	
515-002-1, 515-003-1, 515-004-1, 515-005-1, 515-006-1	
5-250C-1	
527-61-2	
601-180-1	
612-160-1	
625-180-1	
634-250-1	
666-156-1	
980-38-1	

IFF1A003

25-06-2, 25-07-2, 25-08-2, 25-09-2, 25-10-2, 25-11-2, 25-12-2, 25-13-2, 25-14-2, 25-15-2, 25-16-2, 25-17-2, 25-18-2, 25-19-2, 25-21-2, 25-22-2, 25-24-2, 25-27-2, 25-30-2, 25-32-2	
407-4-100, 407-5.5-125, 407-6.5-150, 407-8-175	
409-1-100, 409-2-125, 409-3-150	
9066K6	





CARROS

CARRO DE 6 CAJONES CON FOAMS Y HERRAMIENTAS, 178 piezas



IFF1A004



IFF1A005



IFF1A006

9066K6FF101	1	677 x 501 x 950	80	1.377,51

IFF1A004

101-04-1, 101-045-1, 101-05-1, 101-055-1, 101-06-1, 101-07-1, 101-08-1, 101-09-1, 101-10-1, 101-11-1, 101-12-1, 101-13-1	
103-04-1, 103-05-1, 103-06-1, 103-07-1, 103-08-1, 103-09-1, 103-10-1, 103-11-1, 103-12-1, 103-13-1	
105-22-1, 105-24-1	
105-40-1	
105-42-1	
105-48-1	
105-50-1	
105-70-1	
121-10-1, 121-11-1, 121-12-1, 121-13-1, 121-14-1, 121-15-1, 121-17-1, 121-19-1, 121-22-1, 121-24-1, 121-27-1, 121-30-1, 121-32-1	
125-23-1, 125-25-1	
125-40-1	
125-42-1	
125-48-1	
125-54-1	
125-70-1	
407-4-100, 407-5-5-125, 407-6-5-150, 407-8-175	
408-6-5-25	
409-1-100, 409-2-125, 409-3-150	
409-2-25	
413-1-100, 413-2-125	

IFF1A005

529171	
527-61-2	
475-61-1	
48-9-H	
501-250-1	
511-105-1	
515-002-1, 515-003-1, 515-004-1, 515-005-1, 515-006-1	
5-150C-1, 5-250C-1	
601-180-1	
612-160-1	
625-180-1	
634-250-1	
665-200-1	
980-3B-1	

IFF1A006

25-06-2, 25-07-2, 25-08-2, 25-09-2, 25-10-2, 25-11-2, 25-12-2, 25-13-2, 25-14-2, 25-15-2, 25-16-2, 25-17-2, 25-18-2, 25-19-2, 25-21-2, 25-22-2, 25-24-2, 25-27-2, 25-30-2, 25-32-2	
10-0607-1, 10-0809-1, 10-1011-1, 10-1213-1, 10-1415-1, 10-1617-1, 10-1819-1, 10-2022-1, 10-2123-1, 10-2427-1, 10-3032-1	
9066K6	



CARRO DE 7 CAJONES CON FOAMS Y HERRAMIENTAS, 222 piezas



IFF1A004



IFF1A005



IFF1A006



IFF1A007

E		kg		€	
9066K7FF102	1	677 x 501 x 954	90	1.601,25	
IFF1A004		IFF1A005		IFF1A006	
101-04-1, 101-045-1, 101-05-1, 101-055-1, 101-06-1, 101-07-1, 101-08-1, 101-09-1, 101-10-1, 101-11-1, 101-12-1, 101-13-1		529171		25-06-2, 25-07-2, 25-08-2, 25-09-2, 25-10-2, 25-11-2, 25-12-2, 25-13-2, 25-14-2, 25-15-2, 25-16-2, 25-17-2, 25-18-2, 25-19-2, 25-21-2, 25-22-2, 25-24-2, 25-27-2, 25-30-2, 25-32-2	
103-04-1, 103-05-1, 103-06-1, 103-07-1, 103-08-1, 103-09-1, 103-10-1, 103-11-1, 103-12-1, 103-13-1		527-61-2		10-0607-1, 10-0809-1, 10-1011-1, 10-1213-1, 10-1415-1, 10-1617-1, 10-1819-1, 10-2022-1, 10-2123-1, 10-2427-1, 10-3032-1	
105-22-1, 105-24-1		475-61-1			
105-40-1		48-9-H		IFF1A007	
105-42-1		501-250-1		534261	
105-48-1		511-105-1		534291	
105-50-1		515-002-1, 515-003-1, 515-004-1, 515-005-1, 515-006-1		534321	
105-70-1		5-150C-1, 5-250C-1		534351	
121-10-1, 121-11-1, 121-12-1, 121-13-1, 121-14-1, 121-15-1, 121-17-1, 121-19-1, 121-22-1, 121-24-1, 121-27-1, 121-30-1, 121-32-1		601-180-1		534381	
125-23-1, 125-25-1		612-160-1		534411	
125-40-1		625-180-1		180-05-1, 180-06-1, 180-07-1, 180-08-1, 180-10-1, 180-12-1, 180-14-1, 180-17-1	
125-42-1		634-250-1		180-05X-1, 180-06X-1, 180-07X-1, 180-08X-1, 180-10X-1, 180-12X-1	
125-48-1		665-200-1		183-30-1, 183-40-1, 183-45-1, 183-50-1, 183-55-1, 183-60-1	
125-54-1		980-3B-1		183-40X-1, 183-45X-1, 183-50X-1, 183-55X-1	
125-70-1				458-8-F	
407-4-100, 407-5-5-125, 407-6-5-150, 407-8-175				716-M6-1, 716-M8-1, 716-M11-1, 716-M14-1, 716-M18-1,	
408-6-5-25				801-145-1	
409-1-100, 409-2-125, 409-3-150					
409-2-25					
413-1-100, 413-2-125					
				9066K7	





BANDEJAS DE FOAM 3/3 PARA CARROS DE 26"

IFF1A001



- Foam 3/3 con vasos, carracas y puntas
- 94 piezas

R	Icono	€	
IFF1A001	1	445 x 543 x 40	167,06

045001, 045011, 045021

101-04-1, 101-045-1, 101-05-1, 101-055-1, 101-06-1, 101-07-1, 101-08-1, 101-09-1, 101-10-1, 101-11-1, 101-12-1, 101-13-1, 101-14-1

103-04-1, 103-05-1, 103-06-1, 103-07-1, 103-08-1, 103-09-1, 103-10-1, 103-11-1, 103-12-1, 103-13-1

105-22-1, 105-24-1

105-40-1

105-42-1

105-48-1

105-50-1

105-70-1

106-04-1, 106-05-1, 106-06-1, 106-07-1, 106-08-1

121-10-1, 121-11-1, 121-12-1, 121-13-1, 121-14-1, 121-15-1, 121-16-1, 121-17-1, 121-18-1, 121-19-1, 121-20-1, 121-21-1, 121-22-1, 121-24-1, 121-27-1, 121-30-1, 121-32-1

125-23-1, 125-25-1

125-40-1

125-42-1

125-48-1

125-53-1, 125-54-1

124-14-1, 124-15-1, 124-17-1, 124-19-1, 124-22-1

125-70-1

126-10-1, 126-11-1, 126-12-1, 126-14-1, 126-16-1, 126-18-1, 126-20-1, 126-24-1

475-4-1, 475-5.5-1, 475-6.5-1

475-H3-1, 475-H4-1, 475-H5-1, 475-H6-1

475-PH1-1, 475-PH2-1

475-PZ1-1, 475-PZ2-1

475-T8-1, 475-T10-1, 475-T15-1, 475-T20-1, 475-T25-1, 475-T27-1, 475-T30-1

IFF1A002



- Foam 3/3 con herramientas de golpeo, herramientas de corte, cinta métrica y alicates
- 85 piezas

R	Icono	€	
IFF1A002	1	445 x 543 x 40	170,80

529171

475-61-1

48-9-H

511-105-1

515-002-1, 515-003-1, 515-004-1, 515-005-1, 515-006-1

5-250C-1

527-61-2

601-180-1

612-160-1

625-180-1

634-250-1

666-156-1

980-3B-1

IFF1A003



- Foam 3/3 con destornilladores y llaves combinadas
- 27 piezas

R	Icono	€	
IFF1A003	1	445 x 543 x 40	175,90

25-06-2, 25-07-2, 25-08-2, 25-09-2, 25-10-2, 25-11-2, 25-12-2, 25-13-2, 25-14-2, 25-15-2, 25-16-2, 25-17-2, 25-18-2, 25-19-2, 25-21-2, 25-22-2, 25-24-2, 25-27-2, 25-30-2, 25-32-2

407-4-100, 407-5.5-125, 407-6.5-150, 407-8-175

409-1-100, 409-2-125, 409-3-150



IFF1A004



- Foam 3/3 con juego de vasos, destornilladores y carracas
- 60 piezas

R	1	445 x 543 x 40	€
IFF1A004	1	445 x 543 x 40	185,68
101-04-1, 101-045-1, 101-05-1, 101-055-1, 101-06-1, 101-07-1, 101-08-1, 101-09-1, 101-10-1, 101-11-1, 101-12-1, 101-13-1			
103-04-1, 103-05-1, 103-06-1, 103-07-1, 103-08-1, 103-09-1, 103-10-1, 103-11-1, 103-12-1, 103-13-1			
105-22-1, 105-24-1			
105-40-1			
105-42-1			
105-48-1			
105-50-1			
105-70-1			
121-10-1, 121-11-1, 121-12-1, 121-13-1, 121-14-1, 121-15-1, 121-17-1, 121-19-1, 121-22-1, 121-24-1, 121-27-1, 121-30-1, 121-32-1			
125-23-1, 125-25-1			
125-40-1			
125-42-1			
125-48-1			
125-54-1			
125-70-1			
407-4-100, 407-5-5-125, 407-6-5-150, 407-8-175			
408-6-5-25			
409-1-100, 409-2-125, 409-3-150			
409-2-25			
413-1-100, 413-2-125			

IFF1A005



- Foam 3/3 con herramientas de golpeo, herramientas de corte y alicates
- 87 piezas

R	1	445 x 543 x 40	€
IFF1A005	1	445 x 543 x 40	212,03
529171			
527-61-2			
475-61-1			
48-9-H			
501-250-1			
511-105-1			
515-002-1, 515-003-1, 515-004-1, 515-005-1, 515-006-1			
5-150C-1, 5-250C-1			
601-180-1			
612-160-1			
625-180-1			
634-250-1			
665-200-1			
980-3B-1			

IFF1A006



- Foam 3/3 con llaves combinadas y llaves fijas
- 31 piezas

R	1	445 x 543 x 40	€
IFF1A006	1	445 x 543 x 40	200,88
25-06-2, 25-07-2, 25-08-2, 25-09-2, 25-10-2, 25-11-2, 25-12-2, 25-13-2, 25-14-2, 25-15-2, 25-16-2, 25-17-2, 25-18-2, 25-19-2, 25-21-2, 25-22-2, 25-24-2, 25-27-2, 25-30-2, 25-32-2			
10-0607-1, 10-0809-1, 10-1011-1, 10-1213-1, 10-1415-1, 10-1617-1, 10-1819-1, 10-2022-1, 10-2123-1, 10-2427-1, 10-3032-1			



BANDEJAS DE FOAM 3/3 Y 1/3 PARA CARROS DE 26"

IFF1A007



- Foam 3/3 con juego de vasos, limas y herramientas de corte
- 44 piezas

IFF1A007	1	445 x 543 x 40	164,79
----------	---	----------------	--------

534261		
534291		
534321		
534351		
534381		
534411		
180-05-1, 180-06-1, 180-07-1, 180-08-1, 180-10-1, 180-12-1, 180-14-1, 180-17-1		
180-05X-1, 180-06X-1, 180-07X-1, 180-08X-1, 180-10X-1, 180-12X-1		
183-30-1, 183-40-1, 183-45-1, 183-50-1, 183-55-1, 183-60-1		
183-40X-1, 183-45X-1, 183-50X-1, 183-55X-1		
458-8-F		
716-M6-1, 716-M8-1, 716-M11-1, 716-M14-1, 716-M18-1,		
801-145-1		

IFF1E001

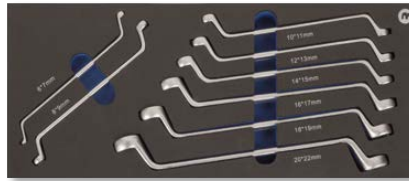

- Bandeja de foam 1/3 con llaves de estrella acodada
- 8 piezas

IFF1E001	1	445 x 181 x 40	68,39
----------	---	----------------	-------

- 15-0607-1, 15-0809-1, 15-1011-1, 15-1213-1, 15-1415-1, 15-1617-1, 15-1819-1, 15-2022-1

IFF1E003



- Bandeja de foam 1/3 con llaves fijas
- 10 piezas

IFF1E003	1	445 x 181 x 40	59,93
----------	---	----------------	-------

- 10-0607-1, 10-0809-1, 10-1011-1, 10-1213-1, 10-1415-1, 10-1617-1, 10-1819-1, 10-2022-1, 10-2427-1, 10-3032-1

IFF1E005



- Bandeja de foam 1/3 con llaves de pipa abiertas hexagonales
- 11 piezas

IFF1E005	1	445 x 181 x 40	152,84
----------	---	----------------	--------

- 52-08-1, 52-10-1, 52-11-1, 52-12-1, 52-13-1, 52-14-1, 52-15-1, 52-16-1, 52-17-1, 52-18-1, 52-19-1

IFF1E002

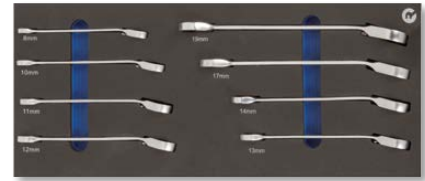

- Bandeja de foam 1/3 con llaves combinadas con carraca
- 8 piezas

IFF1E002	1	445 x 181 x 40	83,60
----------	---	----------------	-------

- 18-08-1, 18-10-1, 18-11-1, 18-12-1, 18-13-1, 18-14-1, 18-17-1, 18-19-1

IFF1E004

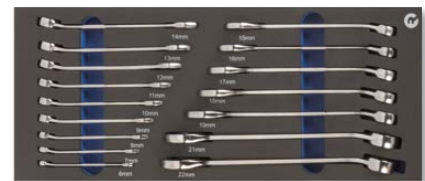

- Bandeja de foam 1/3 con llaves combinadas
- 16 piezas

IFF1E004	1	445 x 181 x 40	79,03
----------	---	----------------	-------

- 25-06-2, 25-07-2, 25-08-2, 25-09-2, 25-10-2, 25-11-2, 25-12-2, 25-13-2, 25-14-2, 25-15-2, 25-16-2, 25-17-2, 25-18-2, 25-19-2, 25-21-2, 25-22-2

IFF1E006

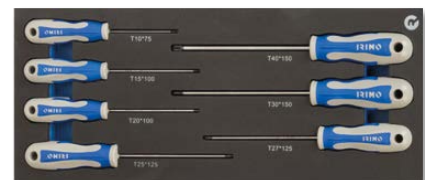

- Bandeja de foam 1/3 con destornilladores TORX®
- 7 piezas

IFF1E006	1	445 x 181 x 40	47,99
----------	---	----------------	-------

- 414-10-75, 414-15-100, 414-20-100, 414-25-125, 414-27-125, 414-30-150, 414-40-150



IFF1E007



- Bandeja de foam 1/3 con destornilladores rectos y planos
- 7 piezas

Q	Icon	Icon	€
IFF1E007	1	445 x 181 x 40	41,10

408-3-75, 408-3.5-100, 408-4-100, 408-5.5-125, 408-6.5-150		
407-8-150		
408-5.5-25		

IFF1E008

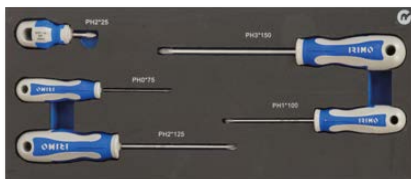

- Bandeja de foam 1/3 con destornilladores Phillips
- 5 piezas

Q	Icon	Icon	€
IFF1E008	1	445 x 181 x 40	34,83

409-0-75, 409-1-100, 409-2-125, 409-3-150		
409-2-25		

IFF1E009

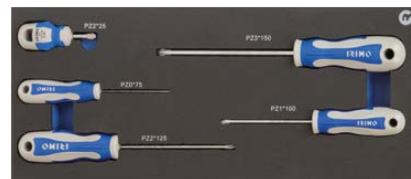

- Bandeja de foam 1/3 con destornilladores stubby y Pozidriv
- 5 piezas

Q	Icon	Icon	€
IFF1E009	1	445 x 181 x 40	35,58

413-0-75, 413-1-100, 413-2-125, 413-3-150		
413-2-25		

IFF1E010

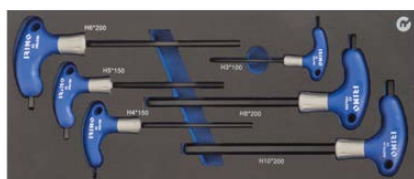

- Bandeja de foam 1/3 con destornilladores mango en "T" hexagonales
- 6 piezas

Q	Icon	Icon	€
IFF1E010	1	445 x 181 x 40	69,32

42-H3-100, 42-H4-150, 42-H5-150, 42-H6-200, 42-H8-200, 42-H10-200		
---	--	--

IFF1E011

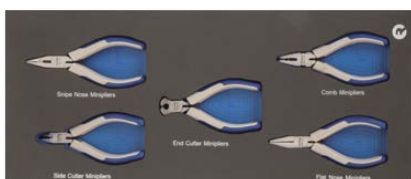

- Bandeja de foam 1/3 con mini alicates
- 5 piezas

Q	Icon	Icon	€
IFF1E011	1	445 x 181 x 40	61,92

601M-125-1	
612M-125-1	
624M-125-1	
626M-125-1	
604M-125-1	

IFF1E012

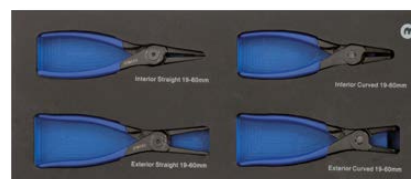

- Bandeja de foam de 1/3 con alicates para arandelas
- 4 piezas

Q	Icon	Icon	€
IFF1E012	1	445 x 181 x 40	91,44

621571	
621671	
621771	
621871	



BANDEJAS DE FOAM 1/3 PARA CARROS DE 26"

IFF1E013

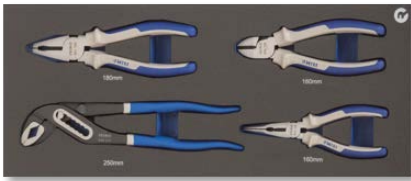

- Bandeja de foam 1/3 con alicates
- 4 piezas

IFF1E013	1	445 x 181 x 40	€ 56,64
----------	---	----------------	---------

601-180-1	
624-160-1	
612-160-1	
634-250-1	

IFF1E014

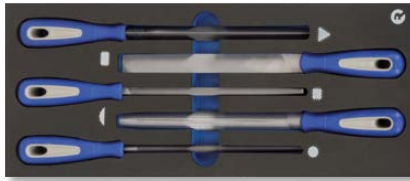

- Bandeja de foam 1/3 con limas
- 5 piezas

IFF1E014	1	445 x 181 x 40	€ 57,30
----------	---	----------------	---------

534411	
534351	
534321	
534291	
534381	

IFF1E015



- Bandeja de foam 1/3 con vasos, carraca y extensiones de 1/2"
- 21 piezas

IFF1E015	1	445 x 181 x 40	€ 141,07
----------	---	----------------	----------

121-10-1, 121-11-1, 121-12-1, 121-13-1, 121-14-1, 121-15-1, 121-16-1, 121-17-1, 121-18-1, 121-19-1, 121-21-1, 121-22-1, 121-23-1, 121-24-1, 121-27-1, 121-30-1, 121-32-1	
125-70-1	
125-42-1	
125-23-1	
125-25-1	

IFF1E016



- Bandeja de foam 1/3 con vasos y accesorios 1/4"
- 18 piezas

IFF1E016	1	445 x 181 x 40	€ 88,81
----------	---	----------------	---------

101-04-1, 101-045-1, 101-05-1, 101-055-1, 101-06-1, 101-07-1, 101-08-1, 101-09-1, 101-10-1, 101-11-1, 101-12-1, 101-13-1, 101-14-1	
105-70-1	
105-42-1	
105-50-1	
105-22-1	
105-24-1	

IFF1E017

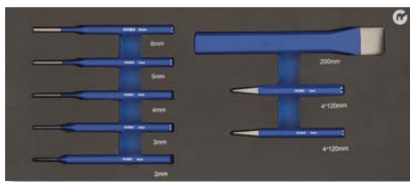

- Bandeja de foam 1/3 con cinceles y cortafríos
- 8 piezas

IFF1E017	1	445 x 181 x 40	€ 51,37
----------	---	----------------	---------

504-200-1	
516-002-1, 516-003-1, 516-004-1, 516-005-1, 516-006-1	
512-010-1, 512-012-1	

IFF1E018



- Bandeja de foam 1/3 con herramienta de golpeo y corte
- 4 piezas

IFF1E018	1	445 x 181 x 40	€ 48,10
----------	---	----------------	---------

529171	
527-51-2	
982-TOR-1	
668-150-1	



IFF1E019



- Bandeja de foam 1/3 con juego puntas, flexómetro, llaves hexagonales y linterna
- 72 piezas

Q	Icono	Icono	€
IFF1E019	1	445 x 181 x 40	60,66

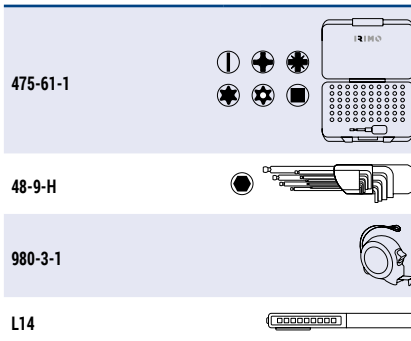

IFF1E024

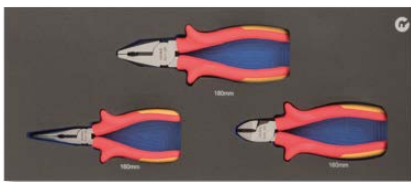

- Bandeja de foam 1/3 con alicates y cortante aislados
- 3 piezas

Q	Icono	Icono	€
IFF1E024	1	445 x 181 x 40	65,60

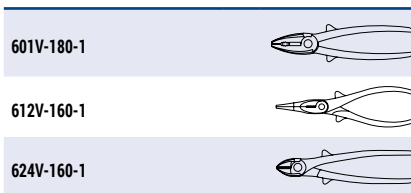

IFF1E021



- Bandeja de foam 1/3 con extractores
- 8 piezas

Q	Icono	Icono	€
IFF1E021	1	445 x 181 x 40	149,27

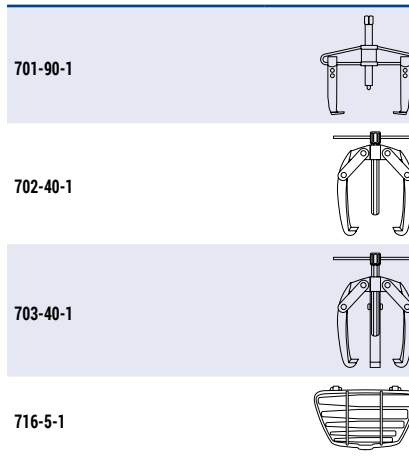

IFF1E025



- Bandeja de foam con destornilladores aislados
- 6 piezas

Q	Icono	Icono	€
IFF1E025	1	445 x 181 x 40	44,99

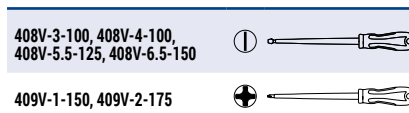

IFF1E023



- Bandeja de foam con llave ajustable y tenaza ajuste rápido
- 2 piezas

Q	Icono	Icono	€
IFF1E023	1	445 x 181 x 40	43,46

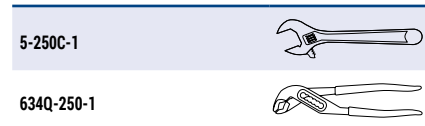



CARROS

CARRO SOPORTE CON CAJAS APILABLES SOBRE RUEDAS



- Los múltiples compartimentos permiten almacenar de manera ordenada las herramientas para evitar pérdidas de tiempo
- Combinación de acero (proporcionando robustez) y polipropileno (ligereza)
- Apoyado en una base de ruedas y mango telescópico, que facilita el transporte aún cuando está muy cargado
- Ruedas goma: 125 x 35 mm
- Incluye candado para bloquear toda la torre
- Los 3 compartimentos se apilan gracias a sus pestañas metálicas laterales
- **Caja superior:** 485 x 225 x 210 mm
Se puede utilizar como caja independiente y se puede cerrar con el candado por separado
Asa grande de aluminio que permite un transporte fácil
Asas retraíbles laterales integradas que ayudan a levantar cuando la carga es elevada
Bandeja incluida 450 x 185 x 45 mm
- **Caja intermedia:** 390 x 215 x 60 mm
2 Cajones con sistema de rodamientos y apertura total
Se puede utilizar como caja independiente y se puede cerrar con el candado por separado
Asas retraíbles laterales integradas que ayudan a levantar cuando la carga es elevada
- **Compartimento inferior integrado:** 403 x 200 x 265 mm
Cajón de amplias dimensiones para alojar herramienta de mayor tamaño y accesorios
- Asa telescópica que conforma la estructura del carro en cuatro posiciones:
645 mm, 800 mm, 900 mm, 995 mm

R	mm	kg	€
9021FTW520	1	520 x 320 x 720	15 242,80

REPUESTOS

		€
9021FTW520-AC1	2 ruedas y husillo	125 x 35 mm 10,12
9021FTW520-AC2	Cierre para torre	3,61
9021FTW520-AC3	Torre con 4 cierres	7,91
9021FTW520-AC4	Mango telescópico	24,53
9021FTW520-AC5	Asa de aluminio caja superior	9,20

TORRE 3 CAJONES CON RUEDAS, 98 piezas



R	mm	kg	€
9021FTW520FF1	1	520 x 320 x 720	22.5 533,44
101-04-1, 101-045-1, 101-05-1, 101-055-1, 101-06-1, 101-07-1, 101-08-1, 101-09-1, 101-10-1, 101-11-1, 101-12-1, 101-13-1, 101-14-1		1/4	
121-08-1, 121-10-1, 121-11-1, 121-12-1, 121-13-1, 121-14-1, 121-16-1, 121-17-1, 121-19-1, 121-21-1, 121-22-1		1/2	
105-70-1		475-1/4-125	
105-40-1		105-50-1	
105-22-1		105-24-1	
105-42-1		125-70-1	
125-40-1		125-43-1	
125-23-1		125-25-1	
46-8-F		475-32-1	
980-3B-1			
407-5.5-125		409-1-100	
407-6.5-150		409-2-125	
612-160-1		601-180-1	
625-180-1		604-160-1	
5-250C-1		522-31-2	
634-250-1		665-200-1	
25-08-1, 25-09-1, 25-10-1, 25-11-1, 25-12-1, 25-13-1, 25-14-1, 25-17-1, 25-19-1			

9021FTW520

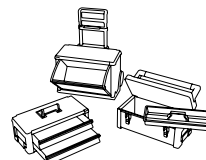



CARRO DOS BANDEJAS



- Fabricado y diseñado para un montaje muy fácil y rápido
- Dos estructuras en U de Aluminio
- Ruedas giratorias de 100 x 25 mm con rodamientos de bola y superficie de TPR que no marca:
2 fijas / 2 giratorias con freno
- Dimensiones de las bandejas:
(2x) 750 x 425 x 77 mm

Artículo	Cant.	Longitud (mm)	Anchura (mm)	Altura (mm)	Diámetro (mm)	Carga (kg)	Peso (kg)	Precio (€)
9064K-02	1	759	432	1.025	300	759 x 432 x h	50	25 x 100 19 168,20
9064K-02T	1		757	425	77		50	3.25 46,23

TRANSPORTADORES

TRANSPORTADOR 90 KG



- Robusto
- Bandas elásticas para asegurar la carga
- Estructura de acero
- Base de aluminio, 250 x 450 mm
- Ruedas 170 mm
- Medidas: 480 x 420 x 740-100 mm
- Peso: 4,3 kg

Artículo	Cant.	Longitud (mm)	Anchura (mm)	Altura (mm)	Diámetro (mm)	Carga (kg)	Peso (kg)	Precio (€)
9063FT90	1	250	450	90	170		4.3	73,57

TRANSPORTADOR



- Estructura de acero robusto
- Ruedas: 2 fijas y 2 giratorias para un fácil manejo
- Mango plegable para fácil almacenamiento y transporte
- Plataforma antideslizante
- Medidas transportador 150 kg:
 - Plegado: 730 x 470 x 225 mm
 - Sin plegar: 730 x 470 x 820 mm
- Medidas transportador 300 kg:
 - Plegado: 920 x 620 x 300 mm
 - Sin plegar: 920 x 620 x 870 mm

Artículo	Cant.	Longitud (mm)	Anchura (mm)	Altura (mm)	Diámetro (mm)	Carga (kg)	Peso (kg)	Precio (€)
9063HT150	1	730	470	150	25 x 100		7.5	61,31
9063HT300	1	920	620	300	25 x 125		15.0	91,98

REPUESTOS

Artículo	Descripción	Artículo	Longitud (mm)	Anchura (mm)	Altura (mm)	Diámetro (mm)	Carga (kg)	Peso (kg)	Precio (€)
9063HT150FI	(2x) ruedas fijas de 4"	9063TH150	130	100	30	0.30		8,00	
9063HT150SW	(2x) ruedas giratorias de 4"	9063TH150	130	100	30	0.35		9,00	
9063HT300FI	(2x) ruedas fijas de 5"	9063TH300	157	125	37	0.80		12,00	
9063HT300SW	(2x) ruedas giratorias de 5"	9063TH300	157	125	37	0.90		13,90	



BANCOS DE TRABAJO

BANCO DE TRABAJO PLEGABLE



NOVEDAD



- Banco de trabajo plegable que soporta hasta 160 kg de peso
- Muy compacto: se pliega para facilitar su transporte y almacenamiento
- Los pasadores de pivote ajustables y las ranuras de retención de la mordaza brindan versatilidad de sujeción y retención segura del material
- Las manivelas de sujeción doble aumentan la fuerza de sujeción y la versatilidad
- Bases de las patas de goma antideslizantes
- Estructura de acero resistente
- Especialmente diseñado para una fácil instalación y limpieza
- Tamaño plegado: 150 x 610 x 900 mm

€					kg	€
9062FWB160	1	760 x 610 x 610	160	7.2	69,50	

CAJAS METÁLICAS

CON DOS ASAS



902021 / 902031



902131

- Caja porta herramientas con asas tubulares fijas que facilita la apertura y su transporte cuando está muy cargada
- Divisores en bandejas superiores para almacenar objetos pequeños
- El sistema de cierre bisagra impide la entrada de suciedad en la caja
- La caja se puede bloquear utilizando los agujeros de las tapas y el candado
- Todas las esquinas están redondeadas para evitar dañar al usuario
- Fabricada en chapa metálica tratada, de gran durabilidad

€					kg	€
902021	1	400 x 210 x 190	3	8	3.4	41,37
902031	1	500 x 210 x 190	3	10	4.1	44,97
902131	1	500 x 210 x 245	5	12	5.4	57,30



CAJA METÁLICA CON ASA PLEGABLE Y 3 BANDEJAS, 95 piezas



Icon	QTY	Dimensions	Weight (kg)	Price (€)
	1	530 x 200 x 200	12.8	296,16

1 & 2 = 90 x 258 mm

1	121-10-1, 121-11-1, 121-12-1, 121-13-1, 121-14-1, 121-15-1, 121-16-1, 121-17-1, 121-18-1, 121-19-1, 121-20-1, 121-21-1, 121-22-1, 121-23-1		
2	121-24-1, 121-27-1, 121-30-1, 121-32-1		
	48-9-H		

3, 5 & 6 = 90 x 525 mm

	624-160-1		
3	601-180-1		
	612-200-1		
	475R-1/4-110		
5	648-250-1		
	666-156-1		
6	25-08-2, 25-09-2, 25-10-2, 25-11-2, 25-12-2, 25-13-2, 25-14-2, 25-15-2, 25-16-2, 25-17-2, 25-18-2, 25-19-2		

4 = 195 x 525 mm

	125-70-1		125-23-1	
	125-40-1		125-52-1	
4	520-43-2		475-32A-1	
	980-5-1			

9020F550

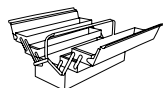

CAJA RÍGIDA DE ALUMINIO, 97 piezas



Icon	QTY	Dimensions	Weight (kg)	Price (€)
	1	460 x 115 x 365	8.8	358,08

	101-04-1, 101-045-1, 101-05-1, 101-055-1, 101-06-1, 101-07-1, 101-08-1, 101-09-1, 101-10-1, 101-11-1, 101-12-1, 101-13-1, 101-14-1			
	121-08-1, 121-10-1, 121-11-1, 121-12-1, 121-13-1, 121-14-1, 121-16-1, 121-17-1, 121-19-1, 121-21-1, 121-22-1			
	25-08-2, 25-09-2, 25-10-2, 25-11-2, 25-12-2, 25-13-2, 25-14-2, 25-17-2, 25-19-12			
	407-5.5-125		409-1-100	
	407-6.5-150		409-2-125	
	105-70-1		105-50-1	
	105-40-1		105-42-1	
	105-22-1		105-24-1	
	125-70-1		125-40-1	
	125-23-1		125-25-1	
	125-43-1			
	46-8-F		475-32-1	
	5-250C-1		604-160-1	
	612-160-1		601-180-1	
	625-180-1		634-250-1	
	522-31-2		665-200-1	
	980-3B-1			





CAJAS METÁLICAS

CAJA RÍGIDA DE ALUMINIO, 145 piezas



Part Number	Quantity	Dimensions (mm)	Weight (kg)	Price (€)
9024-1TS145	1	450 x 115 x 290	12.5	474,96
<p>101-04-1, 101-045-1, 101-05-1, 101-055-1, 101-06-1, 101-07-1, 101-08-1, 101-09-1, 101-10-1, 101-11-1, 101-12-1, 101-13-1, 101-14-1</p>				
<p>121-08-1, 121-10-1, 121-11-1, 121-12-1, 121-13-1, 121-14-1, 121-15-1, 121-16-1, 121-17-1, 121-18-1, 121-19-1, 121-21-1, 121-22-1, 121-24-1, 121-27-1, 121-30-1, 121-32-1</p>				
<p>25-08-2, 25-09-2, 25-10-2, 25-11-2, 25-12-2, 25-13-2, 25-14-2, 25-15-2, 25-16-2, 25-17-2, 25-18-2, 25-19-2</p>				
105-70-1		105-50-1		
105-22-1		105-24-1		
105-40-1		105-42-1		
105-48-1		5-250C-1		
125-23-1		125-25-1		
125-70-1		125-40-1		
125-43-1		125-53-1, 125-54-1		
46-8-F		475-61-1		
801-041-1		980-5-1		
666-156-1		665-200-1		
520-43-2		L-ALUM-1		
634-250-1		632-220-1		
624-160-1		601-180-1		
612-160-1		604-160-1		
984-6D-1		475-5-1		



CAJA DE HERRAMIENTAS DE PLÁSTICO, 48 piezas



🇪🇸	📦	📏	📦	📊	€
9023PT565TS1	1	170 x 565 x 302	10	287,22	
408V-3-100	🌀		408V-4-100	🌀	
408V-5.5-125	🌀		408V-6.5-150	🌀	
409V-1-150	⊕		409V-2-175	⊕	
601V-180-1			612V-160-1		
624V-160-1			629V-160-1		
634V-250-1			429-03-1		
5-200C-1			661051		
801-145-1			666-156-1		
980-3-1			475-32-1		
9023PT565					

CAJA DE HERRAMIENTAS DE PLÁSTICO



- Caja de plástico para herramientas con dos niveles
- Parte superior: 18 compartimentos para almacenar pequeñas piezas
- Resistente tapa transparente
- Con sistema de bloqueo con dos cierres metálicos
- Asa de acero tubular con empuñadura de plástico para mayor confort y fácil transporte

🇪🇸	📦	📏	📦	📊	€
9023PT565	1	170 x 565 x 320	2.4	63,83	





BOLSAS DE TRANSPORTE DE HERRAMIENTA

BOLSA PORTA-HERRAMIENTAS ABIERTA



- Bolsa porta herramientas de fácil transporte y accesibilidad
- Fondo flexible reforzado en plástico duro
- 11 bolsillos verticales para una buena organización
- Mango de aluminio que refuerza toda la estructura con asa de foam para un mejor agarre
- Cinta para colgar del hombro ajustable en altura
- Fibra 600 x 300 que le proporciona resistencia y durabilidad
- Se entrega plegada

🔄	📦	📏	📏	📏	📏	📏	€
9022-1-16SB	1	440 x 210 x 310	21	15	1.5	26,46	

BOLSA PORTA-HERRAMIENTAS ABIERTA



- Bolsa porta herramientas de fácil transporte y accesibilidad
- Base reforzada resistente al agua
- 12 bolsillos verticales en el lateral interiores y exteriores para una buena organización de la herramienta
- Panel interno despegable con 10 bolsillos y gomas para sujeción de la herramienta
- Velcro específico para el transporte de niveles y/o barras
- Mango de aluminio que refuerza toda la estructura con asa de foam para un mejor agarre
- Cinta para colgar del hombro ajustable en altura
- Fibra 600 x 300 que le proporciona resistencia y durabilidad
- Se entrega plegada

🔄	📦	📏	📏	📏	📏	📏	€
9022-1-19HB	1	490 x 240 x 350	32	20	1.5	63,80	

BOLSA PORTA-HERRAMIENTAS CERRADA



- Bolsa con cremallera porta herramientas de fácil transporte y accesibilidad
- Base reforzada resistente al agua
- 10 bolsillos exteriores de diversos tamaños, algunos con tapa protectora y con clip para colocar flexómetros
- 14 bolsillos interiores para una mejor organización de la herramienta
- Cinta para el hombro ajustable para facilitar su transporte
- Fibra 600 x 300 que le proporciona resistencia y durabilidad

🔄	📦	📏	📏	📏	📏	📏	€
9022-2-16HB	1	420 x 240 x 300	24	18	1.2	31,19	

BOLSA PORTA-HERRAMIENTAS CERRADA



- Bolsa con cremallera porta herramientas de fácil transporte y accesibilidad
- Base reforzada resistente al agua
- 17 bolsillos exteriores de diversos tamaños, algunos con tapa protectora y con clip para colocar flexómetros
- 14 bolsillos interiores para una mejor organización de la herramienta
- Cinta para el hombro ajustable para facilitar su transporte
- Fibra 600 x 300 que le proporciona resistencia y durabilidad

🔄	📦	📏	📏	📏	📏	📏	€
9022-2-19HB	1	490 x 240 x 370	35	20	1.5	37,54	



BOLSA PORTA-HERRAMIENTAS, 73 piezas



🔍	📦	📦	kg	€
9022-2-16HBS2	1	420 x 240 x 300	5.3	187,11
109-13-4		475-32-1		
48-9-H		459-6-B		
602-3-C		801-041-1		
980-5-1		10-8-H		
9022-2-16HB				

MOCHILA PORTA HERRAMIENTAS



* La mochila viene sin herramientas

- Alta capacidad de almacenaje con diferentes bolsillos y organizador de herramientas desmontable. 20 L, 16 kg
- Compartimento para portátil
- Organizador desmontable:
 - 10 bolsillos para una mejor organización
- Bolsillo para smartphone en el compartimento frontal
- Poliéster 600D. Resistente y duradera

🔍	📦	📦	📦	kg	€	
9022-BP1	1	300 x 450 x 175	20	16	1.93	59,07

MOCHILA PORTA HERRAMIENTAS CON RUEDAS



* La mochila viene sin herramientas

- Mango telescópico y 2 ruedas fijas para un fácil transporte
- Alta capacidad de almacenaje con diferentes bolsillos y organizador de herramientas desmontable. 26 L, 20 kg
- Compartimento para portátil
- Organizador desmontable con 2 asas:
 - 51 bolsillos para una mejor organización
- Poliéster 600D. Resistente y duradera
- Dos soportes delanteros para estabilizar el peso

🔍	📦	📦	📦	kg	€	
9022-BPW	1	360 x 440 x 220	26	20	4	99,30





PORTAHERRAMIENTAS Y MALETINES

ESTUCHE PORTA HERRAMIENTAS



- Gomas elásticas en base y tapa para una mejor distribución de las herramientas
- Doble cremallera
- Asa de goma suave
- Compartimento para documentación
- Medidas: 258 x 55 x 258 mm

€			g	€
9022-4-26	1	258 x 55 x 258	810	14,71

ESTUCHE PORTA HERRAMIENTAS



- Gomas elásticas en base y tapa para una mejor distribución de las herramientas
- Doble cremallera
- Asa de goma suave
- Compartimento para documentación
- Medidas: 353 x 50 x 310 mm

€			g	€
9022-4-35	1	353 x 50 x 310	810	19,62

JUEGO DE 18 HERRAMIENTAS EN ESTUCHE



€			kg	€
9022-4-26TS1	1	258 x 55 x 258	1.5	61,31

475R-1/4-110		5-200C-1	
624-140-1		601-160-1	
982-TOR-1		980-3-1	
9022-4-26			

JUEGO 28 HERRAMIENTAS EN ESTUCHE



€			kg	€
9022-4-35TS1	1	353 x 50 x 310	3	116,50

475R-1/4-110		46-9-H		
5-200C-1		624-160-1		
601-160-1		520-43-2		
668-150-1		980-5-1		
9022-4-35				



PORTA MARTILLOS



Artículo	Cantidad	Dimensiones	Peso	Precio
9022-3-20	1	170 x 70 x 120	120 g	10,02 €

BOLSA PARA ALICATE



Artículo	Cantidad	Dimensiones	Peso	Precio
9022-3-30	1	260 x 95	40 g	8,77 €

MARTILLO CON SOPORTE PARA CINTURÓN



Artículo	Cantidad	Peso	Precio
9022-3-20TS1	1	790 g	21,28 €

9022-3-20		520-43-2	
-----------	--	----------	--

SET CON 4 HERRAMIENTAS PARA ELECTRICISTA CON ALICATE UNIVERSAL



Artículo	Cantidad	Dimensiones	Peso	Precio
9022-3-30TS1	1	260 x 95 x 30	580 g	35,05 €

407-4-100		409-1-100	
601-180-1		668-150-1	
9022-3-30			

MARTILLO CON SOPORTE PARA CINTURÓN



Artículo	Cantidad	Peso	Precio
9022-3-20TS2	1	790 g	25,04 €

9022-3-20		520-41-2	
-----------	--	----------	--

SET CON 4 HERRAMIENTAS PARA ELECTRICISTA



Artículo	Cantidad	Dimensiones	Peso	Precio
9022-3-30TS2	1	260 x 95 x 30	550 g	36,31 €

407-4-100		409-1-100	
624-160-1		668-150-1	
9022-3-30			





PORTAHERRAMIENTAS Y MALETINES

BOLSA DE HERRAMIENTAS



🔄	📦	📦	📅	€
9022-3-40	1	290 x 10 x 150	60	13,77

BOLSA CON 10 COMPARTIMENTOS



🔄	📦	📦	📅	€
9022-3-50	1	260 x 70 x 355	480	23,79

BOLSA CON 7 HERRAMIENTAS PARA MANTENIMIENTO GENERAL



🔄	📦	📦	📅	€
9022-3-40TS1	1	290 x 60 x 150	1000	63,85

407-6.5-150	🔩	409-2-125	🔩
624-140-1	🔧	601-160-1	🔧
665-200-1	🔪	5-150C-1	🔧
9022-3-40	🔧	980-3-1	🔧

BOLSA CON 9 HERRAMIENTAS PARA MANTENIMIENTO GENERAL



🔄	📦	📦	📅	€
9022-3-50TS1	1	260 x 95 x 355	2400	86,37

407-5.5-125	🔩	409-1-100	🔩
407-6.5-150	🔩	409-2-125	🔩
520-43-2	🔨	634-250-1	🔧
624-160-1	🔧	982-TOR-1	🔧
9022-3-50	🔧	980-5-1	🔧

BOLSA CON 7 HERRAMIENTAS DE SEGURIDAD



🔄	📦	📦	📅	€
9022-3-40TS2	1	290 x 60 x 150	1000	81,38

408V-4-100	🔩	409V-1-150	🔩
624V-160-1	🔧	612V-160-1	🔧
665-200-1	🔪	5-150C-1	🔧
9022-3-40	🔧	980-3-1	🔧

CINTURÓN AJUSTABLE



🔄	📦	📦	📅	€
9022-3-10	1	1500 x 10 x 75	200	11,27

A full-page photograph of a male mechanic with a beard, wearing a blue work uniform, looking upwards while working on a car engine. He is holding a silver adjustable wrench in his left hand. The scene is dimly lit with a strong blue color cast. A yellow, textured horizontal band is overlaid across the middle of the image.

02. LLAVES



LLAVES AJUSTABLES INGLESAS

MOLETA LATERAL

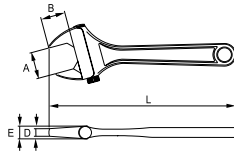

- Material: CrV; Acabado: Mate
- Dureza: 40-45 HRc
- Ángulo de cabeza 15° que proporciona mayor accesibilidad en espacios confinados
- UNE 16532, ISO 6787, DIN 3117

R	Envase	Wrench	A mm	B mm	D mm	E mm	L mm	g	€
001021	5	150 mm - 6"	21	18.5	6.5	12	155	140	26,60
001031	5	200 mm - 8"	29	26	8	14	205	290	30,33
001041	5	250 mm - 10"	34	32	9	17	255	510	35,99
001051	3	300 mm - 12"	39	36	10	20	305	795	45,99
001061	1	400 mm - 16"	49	44	14	26	405	1.620	76,97
001071	1	500 mm - 20"	62	53	17	30	500	2.860	146,30
001081	1	750 mm - 30"	78	70	23	37	750	5.550	285,87

MOLETA CENTRAL

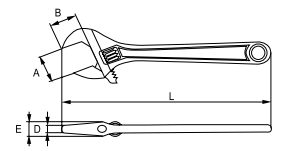

- Material: CrV; Acabado: Fosfatada
- Dureza: 40-45 HRc
- Ángulo de cabeza 15° que proporciona mayor accesibilidad en espacios confinados
- UNE 16532, ISO 6787, DIN 3117
- -1 Envase individual
- -2 Envase industrial

R	Envase	Wrench	A mm	B mm	D mm	E mm	L mm	g	€
5-100-1	5	100 mm - 4"	13	13.5	3.5	9	115	60	11,01
5-150-1	5	150 mm - 6"	20	21	5.5	12	160	130	11,62
5-200-1	5	200 mm - 8"	24	26	7.5	13.5	205	250	13,37
5-250-1	5	250 mm - 10"	29	29.5	9	16	260	405	16,43
5-300-1	5	300 mm - 12"	36	36	11	19	310	650	21,66
5-100-2	60	100 mm - 4"	13	13.5	3.5	9	115	60	9,88
5-150-2	50	150 mm - 6"	20	21	5.5	12	160	130	11,02
5-200-2	40	200 mm - 8"	24	26	7.5	13.5	205	250	12,59
5-250-2	30	250 mm - 10"	29	29.5	9	16	260	405	15,74
5-300-2	20	300 mm - 12"	36	36	11	19	310	650	21,02
5-375-2	1	375 mm - 15"	43	45	13	24	385	1.230	42,69
5-450-2	1	450 mm - 18"	57	53	15	27.5	465	2.000	68,92

MOLETA CENTRAL

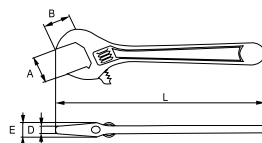

- Material: CrV; Acabado: Cromada
- Dureza: 40-45 HRc
- Ángulo de cabeza 15° que proporciona mayor accesibilidad en espacios confinados
- UNE 16532, ISO 6787, DIN 3117
- -1 Envase individual
- -2 Envase industrial

R	Envase	Wrench	A mm	B mm	D mm	E mm	L mm	g	€
5-100C-1	5	100 mm - 4"	13	13.5	3.5	9	115	60	11,29
5-150C-1	5	150 mm - 6"	20	21	5.5	12	160	130	11,83
5-200C-1	5	200 mm - 8"	24	26	7.5	13.5	205	250	13,61
5-250C-1	5	250 mm - 10"	29	29.5	9	16	260	405	16,56
5-300C-1	5	300 mm - 12"	36	36	11	19	310	650	21,92
5-375C-2	1	375 mm - 15"	43	45	13	24	385	1.230	43,06
5-450C-2	1	450 mm - 18"	57	53	15	27.5	465	2.000	71,85



JUEGO 4 LLAVES AJUSTABLES INGLESAS FOSFATADAS



- Material: CrV: Acabado: Fosfatada
- Dureza: 40-45 HRc
- Ángulo de cabeza 15° que proporciona mayor accesibilidad en espacios confinados
- UNE 16532, ISO 6787, DIN 3117

R		X		g	€
5-4-W	1	4	50 x 330 x 110	1.500	70,09
5-150-2, 5-200-2, 5-250-2, 5-300-2					

LLAVES FIJAS

LLAVES FIJAS

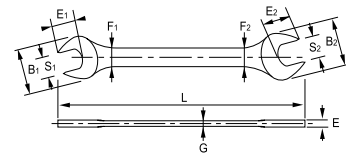

- Acero aleado de alto rendimiento cromado acabado mate
- Dureza: 42-50 HRc
- DIN 3110, ISO 10102, ISO 1085, ISO 1711, ISO 691, ISO 3318
- -1 Envase individual

E		S1 x S2 mm	L mm	B1 mm	B2 mm	F1 mm	F2 mm	E1 mm	E2 mm	E mm	G mm	g	€
10-0405-1	1	4 x 5	105	13	15	6.5	7.5	7.2	7	3.2	2.5	15	2,70
10-0607-1	1	6 x 7	122	17.4	19.4	7.5	8.5	8.1	9	4.1	2.8	21	2,70
10-0809-1	1	8 x 9	137	20.4	22.4	8.5	9.5	10.5	11.2	4.6	3.3	30	2,76
10-1011-1	1	10 x 11	151.4	24.2	27.2	10.5	11.5	11.6	13.3	5.4	3.8	46	2,99
10-1013-1	1	10 x 13	151.4	24.2	37.2	10.5	11.5	11.6	13.3	5.4	3.8	46	3,64
10-1213-1	1	12 x 13	166.5	29.4	31.4	12.5	13.5	13.6	15.3	6.1	4	66	3,66
10-1415-1	1	14 x 15	182	32.4	35.4	13.5	14.5	16	17.5	6.5	4.4	95	3,87
10-1617-1	1	16 x 17	196.5	36.4	38.4	15.5	16.5	18.5	19.6	6.9	4.8	124	4,48
10-1719-1	1	17 x 19	221	40.4	42.4	16.5	18.5	20.8	22.4	7.4	5.1	160	5,05
10-1819-1	1	18 x 19	211.9	40.4	42.4	16.5	18.5	20.8	21.2	7.4	5.1	157	5,05
10-2022-1	1	20 x 22	226.9	43.4	47.4	18.5	19.5	23.3	24.5	8.6	5.6	188	5,93
10-2123-1	1	21 x 23	241.9	46.4	50.4	18.5	20.5	23.6	26	9.2	5.8	211	6,47
10-2224-1	1	22 x 24	241.9	46.4	50.4	18.5	20.5	23.6	26	9.2	5.8	208	6,52
10-2426-1	1	24 x 26	261.9	50.4	54.4	21.5	23.5	27.9	29.8	10	6.2	293	7,99
10-2427-1	1	24 x 27	261.9	50.4	54.4	21.5	23.5	27.9	29.8	10	6.2	284	8,59
10-2528-1	1	25 x 28	281.9	54.4	59.4	23.5	24.5	28.6	30.7	10.6	6.6	366	10,91
10-2729-1	1	27 x 29	282.4	54.6	59.6	23.5	24.5	28.6	30.7	10.6	6.6	362	11,83
10-3032-1	1	30 x 32	302.9	61.4	68.4	24.5	26.5	33.4	35.5	11	7	481	13,01



LLAVES FIJAS

JUEGO 8 LLAVES FIJAS



- Acero aleado de alto rendimiento cromado acabado mate
- Dureza: 42-50 HRc
- DIN 3110, ISO 10102, ISO 1085, ISO 1711, ISO 691, ISO 3318

10-8-H	1	8	250 x 120 x 50	870	€ 31,69
--------	---	---	----------------	-----	---------

10-0607-1, 10-0809-1, 10-1011-1, 10-1213-1, 10-1415-1, 10-1617-1, 10-1819-1, 10-2022-1

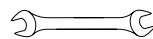

JUEGO 12 LLAVES FIJAS



- Acero aleado de alto rendimiento cromado acabado mate
- Dureza: 42-50 HRc
- DIN 3110, ISO 10102, ISO 1085, ISO 1711, ISO 691, ISO 3318

10-12-H	1	12	350 x 150 x 70	2.975	€ 65,85
---------	---	----	----------------	-------	---------

10-0607-1, 10-0809-1, 10-1011-1, 10-1213-1, 10-1415-1, 10-1617-1, 10-1819-1, 10-2022-1, 10-2123-1, 10-2426-1, 10-2528-1, 10-3032-1

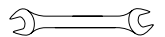

JUEGO 12 LLAVES FIJAS



- Acero aleado de alto rendimiento cromado acabado mate
- Dureza: 42-50 HRc
- DIN 3110, ISO 10102, ISO 1085, ISO 1711, ISO 691, ISO 3318

10-12-W	1	12	400 x 140 x 100	2.975	€ 69,68
---------	---	----	-----------------	-------	---------

10-0607-1, 10-0809-1, 10-1011-1, 10-1213-1, 10-1415-1, 10-1617-1, 10-1819-1, 10-2022-1, 10-2123-1, 10-2426-1, 10-2528-1, 10-3032-1

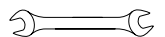



LLAVES COMBINADAS

LLAVES COMBINADAS EN MILÍMETROS

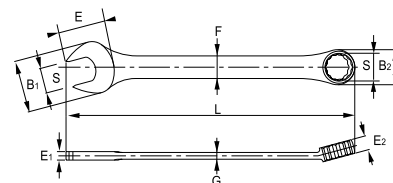

- Acero aleado de alto rendimiento cromado acabado mate
- Dureza: 42-50 HRC
- DIN 3113, ISO 1711-1, ISO 3318, ISO 691, ISO 7738
- -1 Envase individual
- -2 Envase industrial

R	S mm	L mm	B1 mm	B2 mm	F mm	E mm	E1 mm	E2 mm	G mm	g	€
25-06-1	6	103	15.7	10.6	6.2	7.9	3.7	5.2	3	15	2,75
25-07-1	7	109	18	12.1	6.8	8.2	3.7	5.5	3	17	2,81
25-08-1	8	119	18.8	13.6	6.8	9.9	4.0	6	3.3	21	2,88
25-09-1	9	124	21	15.1	7.9	10.4	4.0	6.8	3.4	26	3,42
25-10-1	10	134	22.8	16.2	8.6	10.7	4.8	7	3.6	38	3,44
25-11-1	11	143	25.8	17.1	9.1	12.6	4.8	7.5	3.6	39	3,75
25-12-1	12	154	27.8	18.9	10	13.2	5.2	8	4.2	51	3,96
25-13-1	13	164	29.8	20.2	11.5	14.6	5.2	8.3	4.2	63	4,19
25-14-1	14	174	29.8	21.2	11.4	15.8	5.8	8.9	4.6	68	4,36
25-15-1	15	183	34.1	22.3	12.2	16.9	5.8	8.9	4.6	85	4,49
25-16-1	16	194	35.1	23.8	13.2	17.6	6.3	9.5	5	107	4,76
25-17-1	17	203	37.2	25.3	14.4	18.6	6.3	10	5	118	5,09
25-18-1	18	214	39.2	26.8	14.4	20.5	6.7	10.5	5.2	137	5,36
25-19-1	19	228	41.4	28.3	15.8	21.1	7.0	11.2	5.2	163	6,12
25-20-1	20	240	42.4	29.7	17.3	22.8	7.5	11.4	5.5	186	6,18
25-21-1	21	249.5	45.4	32.4	17.3	22.8	8.6	12.6	6	210	7,08
25-22-1	22	249.5	45.4	32.4	17.3	22.8	8.6	12.2	6	202	7,14
25-23-1	23	270	49.7	36.1	20.3	25	9.2	13.6	6.4	281	7,55
25-24-1	24	270	49.7	36.1	20.3	25	9.2	13.6	6.4	276	7,91
25-25-1	25	289.5	53.4	39.6	22.5	27.6	9.6	14.2	6.8	346	8,57
25-26-1	26	289.5	53.4	39.6	22.5	27.6	9.6	14.2	6.8	345	10,18
25-27-1	27	310	58.4	41.6	23.3	29.5	10.0	14.6	7.2	382	11,25
25-28-1	28	310	58.4	41.6	23.3	29.5	10.0	14.6	7.2	402	11,96
25-29-1	29	330	60.4	45.6	23.3	32.1	10.6	15.6	7.6	476	12,26
25-30-1	30	330	60.4	45.6	23.3	32.1	10.6	15.6	7.6	468	13,62
25-32-1	32	349	67.4	48.8	25.3	35.6	11.2	17.8	8	567	14,69
25-34-1	34	350	67.4	48.8	25.3	35.6	11.2	17.8	8	541	18,43

R	S mm	L mm	B1 mm	B2 mm	F mm	E mm	E1 mm	E2 mm	G mm	g	€
25-06-2	6	103	15.7	10.6	6.2	7.9	3.7	5.2	3	15	2,75
25-07-2	7	109	18	12.1	6.8	8.2	3.7	5.5	3	17	2,81
25-08-2	8	119	18.8	13.6	6.8	9.9	4.0	6	3.3	21	2,88
25-09-2	9	124	21	15.1	7.9	10.4	4.0	6.8	3.4	26	3,42
25-10-2	10	134	22.8	16.2	8.6	10.7	4.8	7	3.6	38	3,44
25-11-2	11	143	25.8	17.1	9.1	12.6	4.8	7.5	3.6	39	3,75
25-12-2	12	154	27.8	18.9	10	13.2	5.2	8	4.2	51	3,96
25-13-2	13	164	29.8	20.2	11.5	14.6	5.2	8.3	4.2	63	3,73
25-14-2	14	174	29.8	21.2	11.4	15.8	5.8	8.9	4.6	68	3,88
25-15-2	15	183	34.1	22.3	12.2	16.9	5.8	8.9	4.6	85	4,03
25-16-2	16	194	35.1	23.8	13.2	17.6	6.3	9.5	5	107	4,29
25-17-2	17	203	37.2	25.3	14.4	18.6	6.3	10	5	118	4,63
25-18-2	18	214	39.2	26.8	14.4	20.5	6.7	10.5	5.2	137	4,90
25-19-2	19	228	41.4	28.3	15.8	21.1	7.0	11.2	5.2	163	5,66
25-20-2	20	240	42.4	29.7	17.3	22.8	7.5	11.4	5.5	186	5,72
25-21-2	21	249.5	45.4	32.4	17.3	22.8	8.6	12.6	6	210	6,61
25-22-2	22	249.5	45.4	32.4	17.3	22.8	8.6	12.2	6	202	6,68
25-23-2	23	270	49.7	36.1	20.3	25	9.2	13.6	6.4	281	7,09
25-24-2	24	270	49.7	36.1	20.3	25	9.2	13.6	6.4	276	7,45
25-25-2	25	289.5	53.4	39.6	22.5	27.6	9.6	14.2	6.8	346	8,09
25-26-2	26	289.5	53.4	39.6	22.5	27.6	9.6	14.2	6.8	345	9,72
25-27-2	27	310	58.4	41.6	23.3	29.5	10.0	14.6	7.2	382	10,77
25-28-2	28	310	58.4	41.6	23.3	29.5	10.0	14.6	7.2	402	11,49
25-29-2	29	330	60.4	45.6	23.3	32.1	10.6	15.6	7.6	476	11,79
25-30-2	30	330	60.4	45.6	23.3	32.1	10.6	15.6	7.6	468	13,16
25-32-2	32	349	67.4	48.8	25.3	35.6	11.2	17.8	8	567	14,23
25-34-2	34	350	67.4	48.8	25.3	35.6	11.2	17.8	8	541	17,97
25-36-2	36	401	74	54	31	62	10.4	17	8	787	27,46
25-41-2	41	436	82	61	34	70	12	19.5	8	1.070	38,48
25-46-2	46	556	92	66	33.6	79.8	15	23	11	1.750	49,68
25-50-2	50	602	100	73	36.6	86.7	17	26	12	2.200	57,79
25-55-2	55	612	113	84	42	94	18	28	14.5	3.070	130,08
25-60-2	60	660	125	90	47	100	20	30	16	3.500	172,72
25-65-2	65	710	132	98	52	110	21	34	18	4.750	230,14
25-70-2	70	760	140	102	52	110	22	35	18	5.550	273,66
25-75-2	75	810	150	108	55	120	25	38	19	6.800	345,00
25-80-2	80	820	179	131	60	120	30	38	20	10.000	466,22
25-85-2	85	820	179	131	60	120	30	38	20	10.000	581,34
25-90-2	90	790	179	131	60	120	30	38	20	10.000	581,34
25-95-2	95	860	187	145	62	120	32	43	20	12.000	581,34
25-100-2	100	860	187	145	62	120	32	43	20	12.000	719,49



LLAVES COMBINADAS

LLAVES COMBINADAS EN PULGADAS

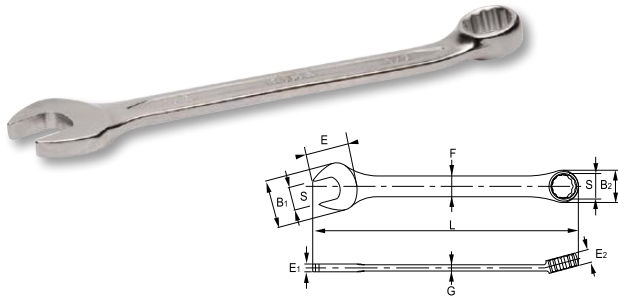

- Acero aleado de alto rendimiento cromado acabado mate
- Dureza: 42-50 HRc
- DIN 3113, ISO 1711-1, ISO 3318, ISO 691, ISO 7738
- -1 Envase individual
- -2 Envase industrial

IRIMO	Envase	S	L	B1	B2	F	E	E1	E2	G	g	€
		mm	mm	mm	mm	mm	mm	mm	mm	mm		
25A-08-1	1	1/4"	103	15.9	10.6	6.6	7.9	3.7	5.2	3	15	2,84
25A-10-1	1	5/16"	119	19	13.6	7.2	9.9	4	6	3.3	21	2,93
25A-12-1	1	3/8"	124	21.2	15.1	8.3	10.4	4	6.8	3.4	26	3,48
25A-14-1	1	7/16"	143	26	17.1	9.5	12.6	4.8	7.5	3.6	39	3,87
25A-16-1	1	1/2"	164	30	20.2	11.9	14.6	5.2	8.3	4.2	63	4,28
25A-18-1	1	9/16"	174	30	21.2	11.8	15.8	5.8	8.9	4.6	68	4,47
25A-20-1	1	5/8"	194	35.3	23.8	13.6	17.6	6.3	9.5	5	107	4,89
25A-22-1	1	11/16"	214	39.4	26.8	14.8	20.5	6.7	10.5	5.2	137	5,18
25A-24-1	1	3/4"	228	41.6	28.3	16.2	21.1	7	11.2	5.2	163	6,18
25A-26-1	1	13/16"	249.5	45.4	32.4	17.3	22.8	8.6	12.6	6	210	7,21
25A-28-1	1	7/8"	249.5	45.4	32.4	17.3	22.8	8.6	12.6	6	210	7,31
25A-30-1	1	15/16"	270	49.7	36.1	20.3	25	9.2	13.6	6.4	281	8,15
25A-32-1	1	1"	289.5	53.4	39.6	22.5	27.6	9.6	14.2	6.8	346	8,79
25A-34-1	1	1.1/16"	310	58.4	41.6	23.3	29.5	10	14.6	7.2	382	11,42
25A-36-1	1	1.1/8"	330	60.4	45.6	23.3	32.1	10.6	15.6	7.6	476	12,19
25A-40-1	1	1.1/4"	349	67.4	48.8	25.3	35.6	11.2	17.8	8	567	14,94
25A-44-1	1	1.3/8"	350	67.4	48.8	25.3	35.6	11.2	17.8	8	541	27,38
25A-46-1	1	1.7/16"	401	74	54	31	62	10.4	17	8	787	27,82
25A-48-1	1	1.1/2"	401	74	54	31	62	10.4	17	8	787	28,25
25A-52-1	1	1.5/8"	435	80	61	34	70	11.5	19.5	8	1.050	39,42
25A-58-1	1	1.13/16"	555	91	66	34	79.8	15	23	11	1.850	66,75
25A-64-1	1	2"	602	100	73	36.6	86.7	17	26	12	2.215	77,35
25A-08-2	1	1/4"	103	15.9	10.6	6.6	7.9	3.7	5.2	3	15	2,36
25A-10-2	1	5/16"	119	19	13.6	7.2	9.9	4	6	3.3	21	2,47
25A-12-2	1	3/8"	124	21.2	15.1	8.3	10.4	4	6.8	3.4	26	3,02
25A-14-2	1	7/16"	143	26	17.1	9.5	12.6	4.8	7.5	3.6	39	3,41
25A-16-2	1	1/2"	164	30	20.2	11.9	14.6	5.2	8.3	4.2	63	3,83
25A-18-2	1	9/16"	174	30	21.2	11.8	15.8	5.8	8.9	4.6	68	4,00
25A-20-2	1	5/8"	194	35.3	23.8	13.6	17.6	6.3	9.5	5	107	4,42
25A-22-2	1	11/16"	214	39.4	26.8	14.8	20.5	6.7	10.5	5.2	137	4,71
25A-24-2	1	3/4"	228	41.6	28.3	16.2	21.1	7	11.2	5.2	163	5,72
25A-26-2	1	13/16"	249.5	45.4	32.4	17.3	22.8	8.6	12.6	6	210	6,74
25A-28-2	1	7/8"	249.5	45.4	32.4	17.3	22.8	8.6	12.6	6	210	6,85
25A-30-2	1	15/16"	270	49.7	36.1	20.3	25	9.2	13.6	6.4	281	7,68
25A-32-2	1	1"	289.5	53.4	39.6	22.5	27.6	9.6	14.2	6.8	346	8,33

JUEGO 8 LLAVES COMBINADAS



- Acero aleado de alto rendimiento cromado acabado mate
- Dureza: 42-50 HRc
- DIN 3113, ISO 1711-1, ISO 3318, ISO 691, ISO 7738

IRIMO	Envase	X	Envase	g	€
25-8-H	1	8	250 x 120 x 50	875	36,59
25-08-1, 25-10-1, 25-11-1, 25-13-1, 25-14-1, 25-17-1, 25-19-1, 25-22-1					

JUEGO 12 LLAVES COMBINADAS



- Acero aleado de alto rendimiento cromado acabado mate
- Dureza: 42-50 HRc
- DIN 3113, ISO 1711-1, ISO 3318, ISO 691, ISO 7738

IRIMO	Envase	X	Envase	g	€
25-12-H	1	12	350 x 50 x 70	2.975	85,65
25-10-1, 25-11-1, 25-12-1, 25-13-1, 25-14-1, 25-17-1, 25-19-1, 25-22-1, 25-24-1, 25-27-1, 25-30-1, 25-32-1					



JUEGO 12 LLAVES COMBINADAS



- Acero aleado de alto rendimiento cromado acabado mate
- Dureza: 42-50 HRc
- DIN 3113, ISO 1711-1, ISO 3318, ISO 691, ISO 7738

Artículo	Paquete	Caja	Medidas	Peso	Precio
25-12-W	1	12	400 x 140 x 100	2.975	113,76
25-10-1, 25-11-1, 25-12-1, 25-13-1, 25-14-1, 25-17-1, 25-19-1, 25-22-1, 25-24-1, 25-27-1, 25-30-1, 25-32-1					

LLAVES COMBINADAS CON CARRACA

LLAVE COMBINADA CON CARRACA FIJA



- Acero aleado de alto rendimiento cromado acabado mate
- Dureza: 40-50 HRc
- -1 Envase individual

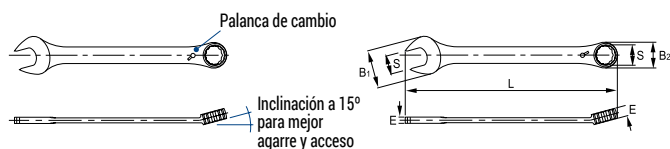

Carraca resistente sobrepasa ISO

Artículo	Paquete	S mm	B1 mm	B2 mm	E mm	L mm	Peso g	Precio €
18-06-1	1	6	15	14.3	4	128	27	7,33
18-07-1	1	7	16.4	16.8	4.4	138	35	7,33
18-08-1	1	8	18	18.3	4.8	140	38	7,33
18-09-1	1	9	20	20	4.8	150	48	7,51
18-10-1	1	10	22	21.5	5.1	160	57	7,51
18-11-1	1	11	24.5	23.5	5.5	165	67	7,95
18-12-1	1	12	26	25	5.9	170	82	8,31
18-13-1	1	13	28	26.4	6.4	180	95	9,34
18-14-1	1	14	30.8	28	6.7	190	113	10,02
18-15-1	1	15	33	30	7.3	200	130	10,44
18-16-1	1	16	24.5	31	7.8	210	158	11,42
18-17-1	1	17	37	33	8	225	180	12,21
18-18-1	1	18	39.5	35	8.2	235	213	12,82
18-19-1	1	19	40.8	36	8.4	245	233	13,37
18-21-1	1	21	44.8	42	9	290	343	16,19
18-22-1	1	22	44.8	42	9	290	345	17,69
18-24-1	1	24	52.8	48	9.7	332	503	20,12
18-27-1	1	27	56	53	10.8	359	550	26,46
18-30-1	1	30	62	58	11.2	404	750	31,22
18-32-1	1	32	65	62	12	424	900	40,26

JUEGO 8 LLAVES COMBINADAS CON CARRACA FIJA



- Acero aleado de alto rendimiento cromado acabado mate
- Dureza: 40-50 HRc

Artículo	Paquete	Caja	Medidas	Peso	Precio
18-8-H	1	8	45 x 245 x 130	870	75,12
18-08-1, 18-10-1, 18-11-1, 18-12-1, 18-13-1, 18-14-1, 18-17-1, 18-19-1					



LLAVES COMBINADAS CON CARRACA

JUEGO 12 LLAVES COMBINADAS CON CARRACA FIJA



- Acero aleado de alto rendimiento cromado acabado mate
- Dureza: 40-50 HRc

Artículo	Paquete	Cantidad	Dimensiones (mm)	Peso (g)	Precio (€)
18-12-H	1	12	180 x 35 x 250	1.510	113,65

18-08-1, 18-09-1, 18-10-1, 18-11-1, 18-12-1, 18-13-1, 18-14-1, 18-15-1, 18-16-1, 18-17-1, 18-18-1, 18-19-1

LLAVES COMBINADAS EXTRACORTAS CON CARRACA FIJA

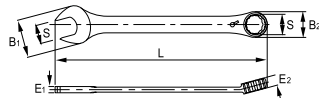

- Acero aleado de alto rendimiento cromado acabado mate
- Dureza: 40-50 HRc
- -1 Envase individual

Artículo	Paquete	S (mm)	B1 (mm)	B2 (mm)	E1 (mm)	E2 (mm)	L (mm)	Peso (g)	Precio (€)
18S-08-1	1	8	18	18.3	5.3	7.2	90	30	5,56
18S-10-1	1	10	22	22	6.0	7.8	96	48	5,73
18S-13-1	1	13	28	28	6.8	9.1	108	72	7,00
18S-17-1	1	17	37	37	8.1	10.5	128	125	9,06
18S-19-1	1	19	40.8	40.8	8.5	11.2	138	163	10,10

JUEGO 5 LLAVES COMBINADAS EXTRACORTAS CON CARRACA FIJA



- Acero aleado de alto rendimiento cromado acabado mate
- Dureza: 40-50 HRc

Artículo	Paquete	Cantidad	Dimensiones (mm)	Peso (g)	Precio (€)
18S-5-H	5	5	8-10-13-17-19 mm	462	37,47

JUEGO 5 LLAVES COMBINADAS DOBLES CON CARRACA FIJA



- Acero aleado de alto rendimiento cromado acabado mate
- Dureza: 40-50 HRc

Artículo	Paquete	Cantidad	Dimensiones (mm)	Peso (g)	Precio (€)
18D-5-H	5	5	8x9, 10x11, 12x13, 16x17, 18x19 mm	664	50,65



LLAVE COMBINADA CON CARRACA ARTICULADA

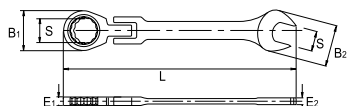

- Acero aleado de alto rendimiento cromado acabado mate
- Dureza: 40-50 HRc
- -1 Envase individual

E	Icono	S mm	B1 mm	B2 mm	E1 mm	E2 mm	L mm	g	€
19-08-1		8	18.3	18	7.2	4.8	140	35	9,34
19-10-1		10	21.5	22	7.8	5.1	160	55	9,59
19-11-1		11	23.5	24.5	8.4	5.5	165	63	10,09
19-12-1		12	25	26	8.8	5.9	170	83	10,51
19-13-1		13	26.4	28	9.1	6.4	180	93	11,85
19-14-1		14	28	30.8	9.4	6.7	190	113	12,82
19-17-1		17	33	37	10.5	8	225	173	15,51
19-19-1		19	36.5	40.8	11.2	8.4	245	233	16,98

JUEGO 8 LLAVES DE CARRACA CON CABEZA FLEXIBLE



- Acero aleado de alto rendimiento cromado acabado mate
- Dureza: 40-50 HRc

E	Icono	Icono	Icono	g	€
19-8-H	1	8	45 x 240 x 140	850	96,50
19-08-1, 19-10-1, 19-11-1, 19-12-1, 19-13-1, 19-14-1, 19-17-1, 19-19-1					

JUEGO 12 LLAVES DE CARRACA CON CABEZA FLEXIBLE



- Acero aleado de alto rendimiento cromado acabado mate
- Dureza: 40-50 HRc

E	Icono	Icono	Icono	g	€
19-12-H	1	12	35 x 180 x 250	1.724	140,11
19-08-1, 19-09-1, 19-10-1, 19-11-1, 19-12-1, 19-13-1, 19-14-1, 19-15-1, 19-16-1, 19-17-1, 19-18-1, 19-19-1					

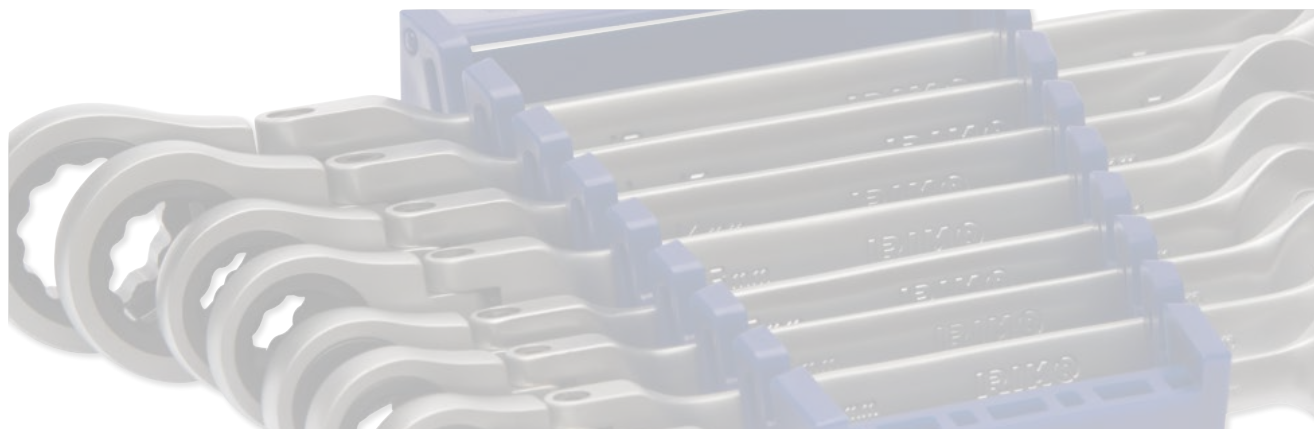



LLAVES DE ESTRELLA PLANA

LLAVE DE ESTRELLA

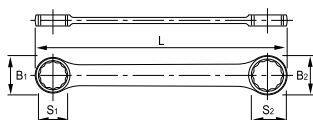

- Acero aleado de alto rendimiento cromado acabado mate
- Dureza: 42-48 HRc
- DIN 837, ISO 10103, ISO 1085

Q		S1 x S2 mm	B1 mm	B2 mm	E mm	L mm	g	€
020011	1	6x7	9.8	11	4.5	95	14	7,73
020031	1	8x9	12.5	14	5.5	110	22	7,99
020051	1	10x11	15	16.5	6	125	32	8,88
020071	1	12x13	18.5	20	6.5	140	46	9,70
020091	1	14x15	21	22.5	7	155	57	10,64
020121	1	16x17	24	25	7.5	170	73	11,43
020141	1	18x19	26.5	27.5	8	185	94	11,89
020171	1	20x22	29	32	9	205	125	13,73
020181	1	21x23	30	33	9.5	225	154	15,03
020201	1	24x26	35	37.8	11	250	210	16,87
020211	1	24x27	35	37.5	11	250	208	16,87
020221	1	25x28	37.5	41	11	275	280	19,06
020241	1	27x29	37.5	41	11	275	272	22,78
020251	1	30x32	43	45.5	12	300	367	24,04

JUEGO LLAVES DE ESTRELLA



- Acero aleado de alto rendimiento cromado acabado mate
- Dureza: 42-48 HRc
- DIN 837, ISO 10103, ISO 1085

Q		X		g	€
021221	1	8	6-7, 8-9, 10-11, 12-13, 14-15, 16-17, 18-19, 20-22 mm	500	88,79
021251	1	12	6-7, 8-9, 10-11, 12-13, 14-15, 16-17, 18-19, 20-22, 21-23, 24-27, 25-28, 30-32 mm	1.550	163,68



LLAVES DE ESTRELLA ACODADA

LLAVE DE ESTRELLA ACODADA

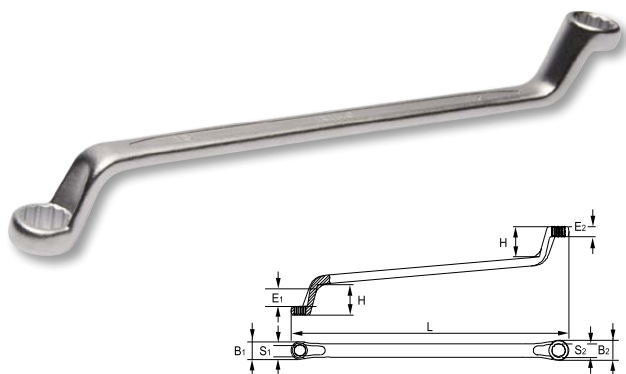

- Acero aleado de alto rendimiento cromado acabado mate
- Dureza: 42-48 HRc
- ISO 10104 y DIN 838
- -1 Envase individual
- -2 Envase industrial

E	Icon	S1 x S2 mm	B1 mm	B2 mm	E1 mm	E2 mm	H mm	L mm	g	€
15-0607-1	1	6x7	10.8	12.5	4.9	5.6	20	170	45	5,39
15-0809-1	1	8x9	13.4	15.3	6.0	6.8	21	182	70	5,91
15-1011-1	1	10x11	16.0	17.8	7.4	7.9	23	197	90	6,26
15-1213-1	1	12x13	18.8	20.2	8.4	8.9	25	213	126	6,73
15-1415-1	1	14x15	20.8	22.5	9.4	9.9	26	228	155	7,13
15-1617-1	1	16x17	24.2	25.7	10.4	10.9	29	246	193	8,51
15-1719-1	1	17x19	27.6	28.7	11.4	11.9	31	265	243	9,92
15-1819-1	1	18x19	27.6	28.7	11.4	11.9	31	265	241	9,92
15-2022-1	1	20x22	29.7	32.5	12.4	12.9	33	288	315	11,40
15-2123-1	1	21x23	31.0	33.2	12.3	13.3	33	310	341	12,98
15-2426-1	1	24x26	34.8	39.2	13.7	14.3	34	330	478	16,05
15-2427-1	1	24x27	34.8	39.2	13.7	14.3	34	330	475	16,30
15-2528-1	1	25x28	36.6	40.5	14.2	14.7	35	348	548	18,73
15-2729-1	1	27x29	42.0	45.2	15.0	16.0	37	372	662	20,78
15-3032-1	1	30x32	42.2	45.5	14.8	15.8	37	372	635	22,84
15-3236-2	1	32x36	48.5	54.0	16.5	17.8	41	417	962	36,35
15-3641-2	1	36x41	53.5	62.0	17.3	19.2	48	450	1.037	45,47

JUEGO 8 LLAVES DE ESTRELLA ACODADAS



- Acero aleado de alto rendimiento cromado acabado mate
- Dureza: 42-48 HRc
- ISO 10104 y DIN 838

E	Icon	Icon	Icon	g	€
15-8-H	1	8	6-7, 8-9, 10-11, 12-13, 14-15, 16-17, 18-19, 20-22 mm	1.245	61,25

JUEGO DE LLAVES DE ESTRELLA ACODADAS



- Acero aleado de alto rendimiento cromado acabado mate
- Dureza: 42-48 HRc
- ISO 10104 y DIN 838

E	Icon	Icon	Icon	g	€
15-8-W	1	8	6-7, 8-9, 10-11, 12-13, 14-15, 16-17, 18-19, 20-22 mm	1.350	64,46
15-12-W	1	12	6-7, 8-9, 10-11, 12-13, 14-15, 16-17, 18-19, 20-22, 21-23, 24-27, 25-28, 30-32 mm	3.465	132,39





LLAVES DE PIPA

LLAVE DE PIPA ABIERTA



- Acero aleado de alto rendimiento cromado acabado mate
- Dureza: 40-50 HRc
- ISO 1711 / ISO 691 / ISO 2236
- -1 Envase individual

6x12		6x6		S	X	D1 mm	D4 mm	G mm	h mm	t mm	L mm	g	6x12		6x6	
Q	Q	€	€													
51-06-1	52-06-1	6	1	10	4.5	21.0	17	6.0	102	30	8,21	8,21				
51-07-1	52-07-1	7	1	11	4.5	22.0	17.5	7.0	106	40	8,58	8,58				
51-08-1	52-08-1	8	1	12.5	7.0	25.0	19.5	8.0	114	60	8,75	8,75				
51-09-1	52-09-1	9	1	13.5	7.0	26.0	20.0	9.0	122	70	9,52	9,52				
51-10-1	52-10-1	10	1	15.0	8.0	28.0	24.0	10.0	129	90	9,85	9,85				
51-11-1	52-11-1	11	1	16.5	8.0	30.0	26.5	11.0	136	120	10,31	10,31				
51-12-1	52-12-1	12	1	18.0	9.0	36.0	28.0	11.0	144	150	10,81	10,81				
51-13-1	52-13-1	13	1	19.5	9.0	38.6	30.0	12.0	152	160	11,80	11,80				
51-14-1	52-14-1	14	1	21.0	10.5	40.0	31.5	13.0	160	190	12,80	12,80				
51-15-1	52-15-1	15	1	22.5	10.5	42.0	34.0	14.0	169	200	13,80	13,80				
51-16-1	52-16-1	16	1	24.0	13.0	46.0	37.0	16.0	178	280	15,20	15,20				
51-17-1	52-17-1	17	1	25.5	13.0	48.0	39.0	17.0	187	300	15,50	15,50				
51-18-1	52-18-1	18	1	26.5	13.0	50.0	40.0	18.0	195	310	16,91	16,91				
51-19-1	52-19-1	19	1	28.5	15.0	51.0	41.0	19.0	204	420	17,52	17,52				
51-20-1	52-20-1	20	1	29.5	15.0	53.0	43.0	20.0	212	450	19,61	19,61				
51-21-1	52-21-1	21	1	30.5	15.0	55.0	46.0	21.0	221	470	21,73	21,73				
51-22-1	52-22-1	22	1	32.0	15.0	57.0	48.0	22.0	230	530	23,42	23,42				
51-23-1	52-23-1	23	1	33.5	18.0	64.0	50.5	23.0	240	650	26,73	26,73				
51-24-1	52-24-1	24	1	34.5	18.0	67.0	54.0	24.0	250	630	27,13	27,13				
51-25-1	52-25-1	25	1	36.0	20.0	69.0	56.0	25.0	260	830	29,81	29,81				
51-26-1	52-26-1	26	1	37.0	20.0	70.0	58.5	26.0	270	860	33,54	33,54				
51-27-1	52-27-1	27	1	38.0	22.0	73.0	58.0	27.0	280	990	36,53	36,53				
51-28-1	52-28-1	28	1	39.5	22.0	75.0	60.0	28.0	290	1.000	40,01	40,01				
51-29-1	52-29-1	29	1	41.0	22.0	76.0	62.0	29.0	300	1.080	42,73	42,73				
51-30-1	52-30-1	30	1	42.0	24.0	83.0	64.0	30.0	310	1.220	45,12	45,12				
51-32-1	52-32-1	32	1	44.5	24.0	88.0	70.0	31.0	330	1.380	46,84	46,84				

JUEGO DE LLAVES DE PIPA ABIERTAS



- Llave de pipa de dos bocas
- Acero aleado de alto rendimiento cromado acabado mate
- Dureza: 40-50 HRc
- ISO 1711 / ISO 691 / ISO 2236

Q	6x12	X	g	€
51-8-W	1	8	8, 10, 11, 13, 14, 17, 19, 22 mm	1.980 114,08
Q	6x6	X	g	€
52-8-W	1	8	8, 10, 11, 13, 14, 17, 19, 22 mm	1.980 114,08



LLAVES DE TUBO

LLAVES DE TUBO DOS BOCAS FORJADA

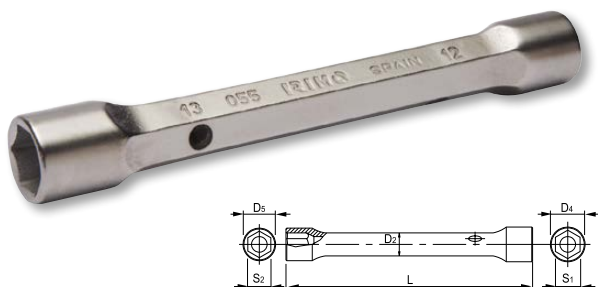

- Acero aleado de alto rendimiento cromado acabado mate
- A partir de la medida de 16, con agujero pasante longitudinal
- Dureza: 42-48 HRc
- UNE 16586

IRIMO	Paquete	S1x S2 mm	D4 mm	D5 mm	D2 mm	L mm	g	€
055011	10	6x7	10	11	7	103	31	11,14
055031	10	8x9	12.5	13.5	9	108	53	11,26
055051	10	10x11	15	16	11	120	78	12,03
055071	10	12x13	17	19	13	138	127	14,13
055091	10	14x15	20	21	14	143	152	15,90
055121	10	16x17	22	24	16	153	185	18,72
055141	10	18x19	25	26	18	163	235	22,02
055171	10	20x22	28	30	20	173	312	25,09
055181	5	21x23	29	31	21	183	359	27,88
055201	5	24x26	33	35	24	193	438	29,78
055211	5	24x27	33	37	24	193	466	30,29
055221	5	25x28	34	37	25	203	535	34,37
055241	5	27x29	37	39	27	208	592	39,20
055251	5	30x32	40	43	30	208	737	43,68

JUEGO LLAVES DE TUBO DOS BOCAS FORJADAS



- Acero aleado de alto rendimiento cromado acabado mate
- A partir de la medida de 16, con agujero pasante longitudinal
- Dureza: 42-48 HRc
- UNE 16586

IRIMO	Paquete	Paquete	Paquete	Paquete	L mm	g	€
056231	1	8	6-7, 8-9, 10-11, 12-13, 14-15, 16-17, 18-19, 20-22 mm	1.150		134,95	
056271	1	12	6-7, 8-9, 10-11, 12-13, 14-15, 16-17, 18-19, 20-22, 21-23, 24-26, 25-28, 30-32 mm	3.200		272,41	

MANGO ESCALONADO PARA LLAVE DE TUBO



- Acero aleado de alto rendimiento
- Dureza: 42-48 HRc
- DIN 900

IRIMO	Paquete	Paquete	Paquete	Paquete	Paquete	Paquete	Paquete	L mm	g	€		
055301	1	3.1	4.3	5.3	5.8	8	-	6x7	14x15	175	54	9,62
055311	1	6.8	7.8	9.8	11.8	12.8	14	16x17	30x32	270	251	13,43





LLAVES DE GOLPE Y TRACCIÓN

LLAVE DE ESTRELLA DE GOLPE

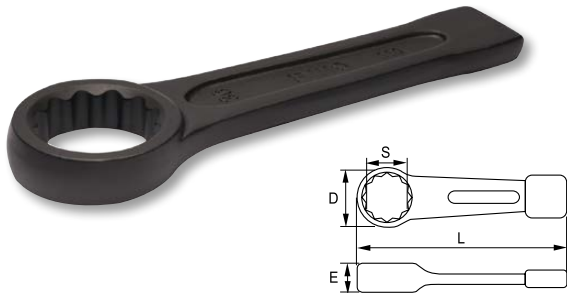

- Acero aleado de alto rendimiento
- Dureza: 24-46 mm, 34-40 HRc
50-100 mm, 30-36 HRc
- DIN 7444

R		S mm	D mm	E mm	L mm	g	€
30-24-2	1	24	43	15	165	235	31,74
30-27-2	1	27	46	16	180	290	34,53
30-30-2	1	30	53	18	195	435	35,57
30-32-2	1	32	53	18	195	415	35,57
30-34-2	1	34	59	18	205	510	40,30
30-36-2	1	36	59	18	205	510	45,40
30-38-2	1	38	59	18	205	510	53,43
30-41-2	1	41	65	20	230	710	56,87
30-46-2	1	46	74	22.5	240	980	63,54
30-50-2	1	50	79	24	255	1.050	71,43
30-55-2	1	55	86	25	270	1.410	81,69
30-60-2	1	60	93	26	280	1.640	86,13
30-65-2	1	65	103	29	300	2.180	89,53
30-70-2	1	70	109	33	315	2.400	93,42
30-75-2	1	75	114	34	330	2.775	100,33
30-80-2	1	80	125	36	348	3.150	133,47
30-85-2	1	85	129	37	360	4.860	178,72
30-90-2	1	90	148	40	379	5.680	233,67
30-95-2	1	95	151	41	395	6.500	258,18
30-100-2	1	100	154	45	405	7.830	290,75

LLAVE FIJA DE GOLPE

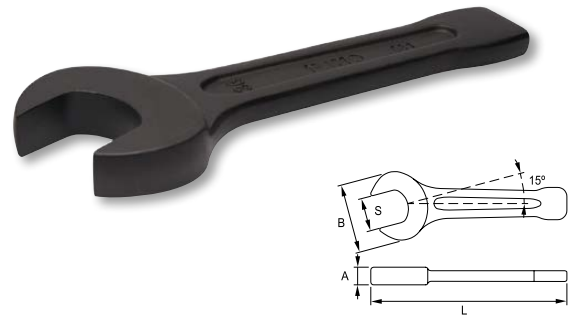

- Acero aleado de alto rendimiento
- Dureza: 30-46 mm, 34-40 HRc
50-85 mm, 30-36 HRc
- DIN 133

R		S mm	A mm	B mm	L mm	g	€
31-30-2	1	30	17	65	190	550	20,78
31-32-2	1	32	17	67	195	560	22,05
31-36-2	1	36	18	77	210	845	28,40
31-41-2	1	41	19	88	230	1.040	34,82
31-46-2	1	46	20	96	250	1.375	46,90
31-50-2	1	50	21	106	275	1.670	53,43
31-55-2	1	55	24	116	305	2.175	62,32
31-60-2	1	60	24	125	315	2.455	74,21
31-65-2	1	65	28	136	345	3.550	92,98
31-70-2	1	70	30	148	370	4.075	111,80
31-75-2	1	75	30	158	385	5.170	119,72
31-80-2	1	80	33	170	400	5.785	167,50
31-85-2	1	85	33	174	410	6.870	199,45



LLAVES DE GANCHO

PIVOTE FIJO

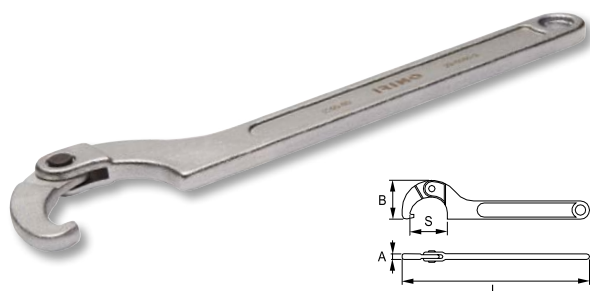

- Acero aleado de alto rendimiento cromado acabado mate
- Dureza: 40 HRc
- DIN 137-B

R		S mm	A mm	B mm	L mm	g	€
29-3550-2	1	35-50	6	38	202	186	23,38
29-5080-2	1	50-80	8	55	280	382	31,88
29-80120-2	1	80-120	9	75	345	642	44,59

PIVOTE REEMPLAZABLE

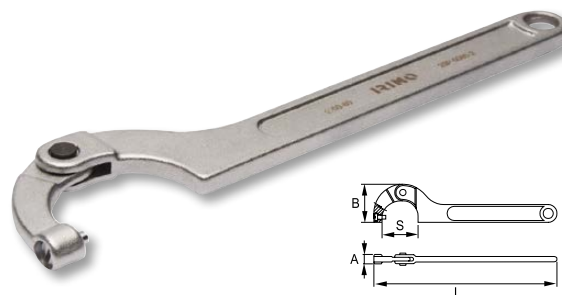

- Acero aleado de alto rendimiento cromado acabado mate
- Dureza: 40 HRc
- DIN 137-B

R		S mm	A mm	B mm	L mm	g	€
29P-3550-2	1	35-50	11	38	202	186	25,50
29P-5080-2	1	50-80	14	55	280	382	34,65
29P-80120-2	1	80-120	18	75	345	642	48,40

REPUESTO PIVOTE REEMPLAZABLE



- Acero aleado de alto rendimiento cromado

R		D mm	g	€
29P-3550-A	1	29P-3550-2	4	5,06
29P-5080-A	1	29P-5080-2	5	5,74
29P-80120-A	1	29P-80120-2	6	6,30

LLAVE UNIVERSAL

LLAVE UNIVERSAL 7 EN 1



- Llave universal adecuada para todas las cerraduras más comunes
- 1 llave para 7 aplicaciones diferentes
- Llave para liberación del aire de los radiadores en la parte central
- Para sistemas de electricidad, calefacción, ventilación y aire acondicionado además de aplicaciones de construcción
- Hecho en fundición de zinc, con cadena, adaptador y punta (1,2x7 mm y PH2)
- Dimensiones: 72x72 mm
- Embalaje en blíster

R									€
71-UN7-1	1	1.2	PH-2	3-5	9	3-5	72x72	89	16,40

LLAVE UNIVERSAL 9 EN 1



- Llave universal para las formas más comunes
- 1 llave para 9 aplicaciones diferentes
- Cuadrado: 5,6,7-8 mm, Triangular: 9-10 mm
- Llave de dos sentidos: 6-9 mm
- Para sistemas de electricidad, calefacción, ventilación y aire acondicionado además de aplicaciones de construcción
- Hecho en fundición de zinc, con cadena, adaptador y punta (1,2x7 mm y PH2)
- Dimensiones: 90x62 mm
- Embalaje en blíster

R									€
71-UN9-1	1	1.2	PH-2	5-7-8	9-10	9-10	90x62	87	15,22



03. HERRAMIENTAS DINAMOMÉTRICAS



LLAVES DINAMOMÉTRICAS

DINAMOMÉTRICA DE DISPARO AJUSTABLE CON CARRACA FIJA

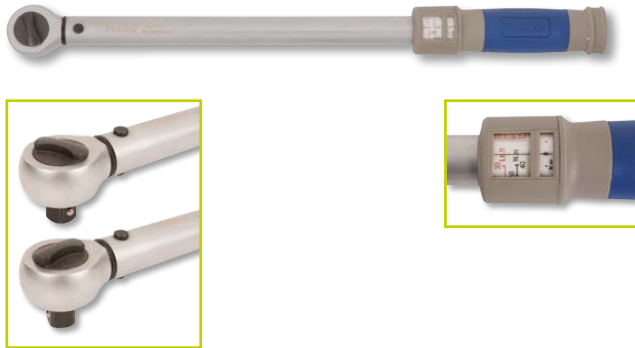

DINAMOMÉTRICA DE DISPARO AJUSTABLE CON CABEZA INTERCAMBIABLE



- Precisión: ± 4%
- Cabeza fija
- Carraca reversible de 45 dientes con ángulo de acción 8°
- Mango de plástico para mayor confort
- ISO 6789

- Precisión: ± 4%
- Cabezas intercambiables 9x12 y 14x18 mm
- Mango de plástico para mayor confort
- ISO 6789

R	📦	Ø	Nm	Δ Nm	L mm	kg	€
070411	1	1/4"	4-20	0.050	275	0.5	144,49
070421	1	3/8"	10-60	0.125	360	0.8	144,49
070431	1	1/2"	25-125	0.25	420	0.9	149,48
070441	1	1/2"	40-200	0.5	460	1.0	156,95
070451	1	1/2"	65-335	0.5	520	1.2	171,91
070461	1	3/4"	65-335	0.5	520	1.2	179,36
070471	1	3/4"	150-800	2	1.040	4.9	623,98
070481	1	1"	300-1500	3	1.250	8.2	1.243,51

R	📦	🔧	Nm	Δ Nm	L mm	kg	€
7309-30	1	9x12	6-30	0.050	298	0.6	127,13
7309-60	1	9x12	10-60	0.125	367	0.7	127,13
7309-125	1	9x12	25-125	0.25	422	0.8	144,98
7314-200	1	14x18	40-200	0.5	455	0.9	160,00
7314-335	1	14x18	65-335	0.5	515	1.1	173,17

CABEZA INTERCAMBIABLE DE BOCA ABIERTA 9x12 MM

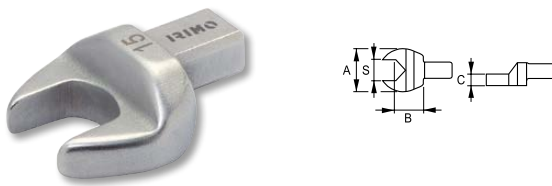

CABEZA INTERCAMBIABLE DE BOCA ESTRELLA 9x12 MM

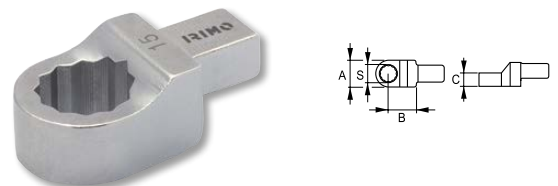

- Cabeza intercambiable de boca abierta 9x12 mm
- Acero forjado cromado

- Cabeza intercambiable de boca estrella 9x12 mm
- Acero forjado cromado

R	📦	S mm	A mm	B mm	C mm	g	€
7309-1-10	1	10	25	17.5	5.7	40	24,75
7309-1-11	1	11	26	17.5	5.7	40	24,75
7309-1-12	1	12	28	17.5	5.7	45	24,75
7309-1-13	1	13	29	17.5	5.7	45	24,75
7309-1-14	1	14	32	20.0	7.7	50	24,75
7309-1-17	1	17	38	20.0	7.7	60	24,75
7309-1-19	1	19	42	20.0	7.7	70	24,75

R	📦	S mm	A mm	B mm	C mm	g	€
7309-2-10	1	10	18	17.5	8	40	26,82
7309-2-11	1	11	19	17.5	8	40	26,82
7309-2-12	1	12	20	17.5	12	50	26,82
7309-2-13	1	13	21	17.5	12	50	26,82
7309-2-14	1	14	23	17.5	12	50	26,82
7309-2-17	1	17	27	17.5	13	50	26,82
7309-2-19	1	19	31	17.5	13	60	26,82
7309-2-22	1	22	35	17.5	15	80	26,82



CABEZA INTERCAMBIABLE DE CABEZA DE CARRACA 9x12 Y 14x18 MM

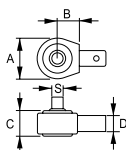

- Inserto cuadrado carraca de 1/4", 3/8" y 1/2" para 9x12 mm
- Inserto cuadrado carraca de 1/2" para 14x18 mm
- Número de dientes 45 con ángulo de acción 8°
- Acero forjado cromado

E		S mm	A mm	B mm	C mm	D mm	Max Nm	g	€
7309-1/4	1	1/4"	37	18	20	9x12	25	135	56,38
7309-3/8	1	3/8"	38	18	20	9x12	160	160	58,65
7309-1/2	1	1/2"	38	18	20	9x12	160	160	59,86
7314-1/2	1	1/2"	40	25	20	14x18	420	265	63,18

CABEZA INTERCAMBIABLE DE BOCA ABIERTA 14x18 MM

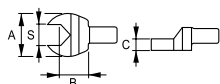

- Cabeza intercambiable de boca abierta 14x18 mm
- Acero forjado cromado

E		S mm	A mm	B mm	C mm	g	€
7314-1-13	1	13	30	25.0	7	130	28,21
7314-1-14	1	14	31	25.0	7	130	28,21
7314-1-17	1	17	37	25.0	9	135	28,21
7314-1-19	1	19	41	25.0	9	140	28,21
7314-1-22	1	22	47	25.0	11	170	33,91
7314-1-24	1	24	51	25.0	11	180	33,91
7314-1-27	1	27	59	32.5	14	220	38,40
7314-1-30	1	30	63	32.5	14	240	38,40
7314-1-32	1	32	65	32.5	14	240	38,40

CABEZA INTERCAMBIABLE DE BOCA ESTRELLA 14x18 MM

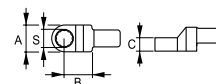

- Cabeza intercambiable de boca estrella 14x18 mm
- Acero forjado cromado

E		S mm	A mm	B mm	C mm	g	€
7314-2-13	1	13	21	25	12	120	29,36
7314-2-14	1	14	23	25	12	120	29,36
7314-2-17	1	17	28	25	13	130	29,36
7314-2-19	1	19	30	25	13	140	29,36
7314-2-22	1	22	35	25	15	145	33,91
7314-2-24	1	24	38	25	15	145	33,91
7314-2-27	1	27	42	31	18	170	33,91
7314-2-30	1	30	45	31	18	180	38,40
7314-2-32	1	32	48	31	18	180	38,40
7314-2-36	1	36	53	31	19	205	41,80
7314-2-41	1	41	59	31	19	235	41,80

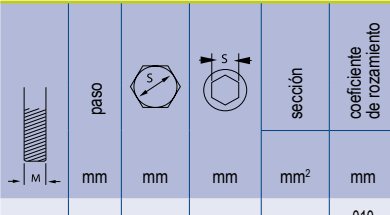

FUERZAS DE PRETENSADO Y PARES DE APRIETE RECOMENDADOS

	paso	mm	mm	mm	sección	coeficiente de rozamiento	CALIDAD DE TORNILLO											
							4,8		5,8		6,8		8,8		10,9		12,9	
							Pretensado N	Apriete Nm	Pretensado N	Apriete Nm	Pretensado N	Apriete Nm	Pretensado N	Apriete Nm	Pretensado N	Apriete Nm	Pretensado N	Apriete Nm
M2	040	40	15	207	010 014	4480 4495	0,15 0,19	610,6 561,9	0,19 0,23	732,7 674,3	0,23 0,28	976,9 899,0	0,31 0,37	1373,8 1264,3	0,43 0,52	1648,6 1517,1	0,52 0,63	
M2,5	045	50	20	3,39	0,10 0,14	813,5 749,9	0,31 0,38	1016,9 937,4	0,39 0,48	1220,2 1124,9	0,47 0,58	1627,0 1499,8	0,63 0,77	2288,0 2109,1	0,88 1,08	2745,6 2531,0	1,06 1,30	
M3	050	55	25	5,03	0,10 0,14	1219,9 1125,9	0,54 0,60	1524,9 1407,4	0,68 0,83	1829,9 1688,9	0,82 1,00	2439,9 2251,9	1,09 1,34	3431,0 3166,7	1,53 1,88	4117,2 3800,0	1,84 2,26	
M3,5	060	60	-	6,78	0,10 0,14	1638,2 1511,3	0,84 1,03	2047,8 1889,2	1,05 1,28	2457,3 2267,0	1,26 1,54	3276,4 3022,6	1,68 2,05	4607,5 4250,6	2,36 2,89	5528,9 5100,7	2,84 3,47	
M4	070	70	30	8,78	0,10 0,14	2115,4 1950,9	1,25 1,53	2644,3 2438,7	1,56 1,91	3173,1 2926,4	1,88 2,29	4230,8 3901,9	2,50 3,06	5949,6 5487,0	3,52 4,30	7139,5 6584,4	4,22 5,16	
M5	080	80	40	14,20	0,10 0,14	3461,6 3196,8	2,46 3,02	4327,0 3996,0	3,08 3,78	5192,3 4795,2	3,70 4,53	6923,1 6393,7	4,93 6,04	9735,7 8991,1	6,93 8,50	11682,8 10789,3	8,32 10,20	
M6	100	100	50	20,10	0,10 0,14	4874,7 4499,1	4,24 5,19	6093,4 5623,9	5,30 6,48	7312,1 6748,6	6,35 7,78	9749,4 8998,2	8,47 10,37	13710,1 12653,7	11,92 14,59	16452,2 15184,4	14,30 17,51	
M7	100	110	-	28,90	0,10 0,14	7134,5 6599,6	6,97 8,60	8918,2 8249,5	8,71 10,76	10701,8 9899,4	10,45 12,90	14269,1 13199,2	13,94 17,21	20065,9 18561,4	19,60 24,20	24079,1 22273,6	23,52 29,04	
M8	125	130	60	36,60	0,10 0,14	8947,1 8265,6	10,20 12,54	11183,9 10332,0	12,75 15,67	13420,7 12398,4	15,30 18,80	17894,2 16531,2	20,41 25,07	25163,7 23247,0	28,70 35,26	30196,5 27896,5	34,44 42,31	
M10	150	160	80	58,00	0,10 0,14	14244,5 13167,4	20,11 24,76	17805,6 16459,2	25,14 30,95	21366,8 19751,1	30,16 37,14	28489,0 26334,8	40,22 49,52	40062,7 37033,3	56,56 69,64	48075,3 44439,9	67,87 83,56	
M12	175	180	100	84,30	0,10 0,14	20766,6 19204,0	34,43 42,42	25958,3 24005,0	43,03 53,03	31149,9 28806,0	51,64 63,63	41533,2 38408,0	68,86 84,84	58406,1 54011,2	96,83 119,31	70087,3 64813,5	116,20 143,17	
M14	200	210	120	115,00	0,10 0,14	28389,9 26261,2	54,77 67,56	35487,4 32826,5	68,46 84,45	42584,9 39391,8	82,15 101,34	56779,8 52522,4	109,53 135,13	79846,6 73859,6	154,03 190,02	95816,0 88631,5	184,84 228,03	
M16	200	240	140	157,00	0,10 0,14	39242,1 36364,2	85,14 105,80	49052,7 45455,3	106,43 132,26	58863,2 54546,3	127,72 158,71	78484,3 72728,5	170,29 211,61	110368,5 102274,4	239,47 297,58	132442,2 122729,3	287,36 357,09	
M18	250	270	140	192,00	0,10 0,14	47533,0 43986,1	117,48 145,16	59416,3 54982,7	146,85 181,45	71299,6 65979,2	176,22 217,74	95066,1 87972,3	234,96 290,32	133686,7 123711,0	330,41 402,26	160424,1 148453,2	396,49 489,92	
M20	250	300	170	245,00	0,10 0,14	61238,0 56747,1	166,08 206,39	76547,5 70933,9	207,61 257,98	91857,0 85120,6	249,13 309,58	122476,0 113494,2	332,17 412,78	172231,9 159601,2	467,11 580,47	206678,2 191521,5	560,54 696,56	
M22	250	340	170	303,00	0,10 0,14	76305,2 70791,9	227,22 283,79	95381,5 88489,8	284,02 354,74	114457,8 106187,8	340,82 425,69	152610,4 141583,7	454,43 567,58	214608,3 199102,1	639,05 798,16	257530,0 238922,5	766,85 957,80	
M24	300	360	190	353,00	0,10 0,14	88232,4 81761,8	287,16 356,84	110290,5 102202,2	358,94 446,05	132348,6 122642,7	430,73 535,26	176646,9 163523,6	574,31 713,68	248153,7 229955,5	807,63 1003,61	297784,4 275941,1	969,15 1204,33	
M27	300	410	190	459,00	0,10 0,14	115778,8 107441,5	420,04 525,08	144723,5 134301,9	525,05 656,35	173668,2 161162,2	306,06 787,62	231557,6 214883,0	840,08 1050,16	325627,9 302179,2	1181,36 1476,79	390753,4 362615,0	1417,63 1772,15	
M30	350	460	220	561,00	0,10 0,14	140999,5 130770,6	572,83 714,49	176249,4 163463,3	716,03 893,11	211499,3 196155,9	859,24 1071,73	281999,0 261541,2	1145,65 1428,97	396561,1 367792,3	1611,08 2009,49	475873,4 441350,8	1933,29 2411,39	
M33	350	500	220	694,00	0,10 0,14	175618,1 163058,0	774,65 970,43	219522,6 203822,5	968,32 1213,03	263427,1 245587,0	1161,98 1455,64	351236,2 326115,9	1549,31 1940,86	493925,8 458600,5	2178,72 2729,33	592711,0 550320,6	2614,46 3275,19	
M36	400	550	240	817,00	0,10 0,14	206081,7 191241,8	998,60 1248,41	257602,2 239052,3	1248,25 1560,51	309122,6 286862,7	1497,89 1872,61	412163,5 382483,6	1997,19 2496,81	579604,8 537867,6	2808,55 3511,14	695525,8 645441,1	3370,26 4213,37	
M39	400	600	270	976,00	0,10 0,14	247520,0 229902,6	1291,81 1620,96	309400,0 287378,3	1614,77 2026,20	371279,9 344853,9	1937,72 2431,44	495039,9 459805,2	2583,63 3241,92	696149,8 646601,0	3633,23 4558,96	835379,8 775921,3	4359,88 5470,75	
M42	450	650	-	1120,00	0,10 0,14	283225,0 262939,0	1601,25 2005,46	354031,2 328673,8	2001,57 2506,83	424837,4 394408,5	2401,88 3008,20	566449,9 525878,0	3202,51 4010,93	796570,1 739516,0	4503,53 5640,37	955884,2 887419,2	5404,23 6768,44	
M45	450	700	320	1310,00	0,10 0,14	332751,5 309151,8	2005,51 2519,55	415939,4 386439,7	2506,89 3149,43	499127,3 463727,7	3008,26 3779,32	665503,0 618303,6	4011,02 5039,09	935863,6 869489,3	5640,50 7086,23	1123036,0 1043387,0	6768,60 8503,47	
M48	500	750	-	1470,00	0,10 0,14	372429,3 345862,9	2406,51 3018,11	465536,6 432328,7	3008,14 3772,64	558644,0 518794,4	3609,77 4527,17	744858,6 691725,8	4813,03 6036,23	1047457,0 972739,4	6768,32 8488,45	1256949,0 1167287,0	8121,98 10186,14	
M52	500	800	360	1760,00	0,10 0,14	448108,9 416499,0	3099,96 3900,52	560136,1 520623,8	3874,95 4875,65	672163,4 624748,5	4649,93 5850,78	896217,8 832998,0	6199,91 7801,04	1260306,0 1171404,0	8718,63 10970,21	1512368,0 1405684,0	10462,36 13164,25	
M56	550	850	410	2030,00	0,10 0,14	516202,9 479683,4	3838,14 4824,40	645253,6 599604,2	4797,68 6030,50	774304,4 719525,1	5757,21 7236,60	1032406,0 959366,8	7676,29 9648,80	1451821,0 1349110,0	10794,78 13568,63	1742185,0 1618931,0	12953,73 16282,36	
M60	550	900	-	2360,00	0,10 0,14	602498,5 560267,5	4754,64 5992,71	753123,1 700334,4	5943,30 7490,88	903747,8 840401,2	7131,96 8989,06	1204997,0 1120535,0	9509,28 11985,42	1694527,0 1575752,0	13372,43 16854,49	2033432,0 1890903,0	16046,91 20225,39	
M64	600	950	460	2680,00	0,10 0,14	683339,5 635299,9	5746,17 7235,13	854174,4 794124,9	7182,71 9043,92	1025009,0 952949,8	8619,25 10852,70	1366679,0 1270600,0	11492,34 14470,27	1921892,0 1786781,0	16161,10 20348,82	2306271,0 2144137,0	19393,32 24418,58	
M68	600	1000	-	3060,00	0,10 0,14	782799,9 728201,8	6939,64 8758,24	978499,8 910252,2	8674,55 10947,80	1174200,0 1092303,0	10409,46 13137,36	1565600,0 1456404,0	13879,28 17516,48	2201625,0 2048068,0	19517,74 24632,55	2641950,0 2457681,0	23421,29 29559,06	



04. VASOS Y ACCESORIOS



VASOS 1/4"

VASOS 1/4" HEX

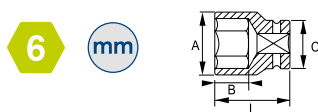

- Vasos en milímetros, diseño hexagonal
- Acero aleado Cromo Vanadio
- Acabado cromado brillante
- Perfil NPP
- DIN 3120, DIN 3124

R			A mm	B mm	C mm	L mm	g	€
101-04-1	5	4	6.9	9.0	12.0	25.0	11	3,45
101-045-1	5	4.5	7.5	9.0	12.0	25.0	11	3,45
101-05-1	5	5	8.2	9.0	12.0	25.0	11	3,45
101-055-1	5	5.5	8.8	9.0	12.0	25.0	12	3,45
101-06-1	5	6	9.4	9.0	12.0	25.0	11	3,45
101-07-1	5	7	11.0	9.0	12.0	25.0	13	3,45
101-08-1	5	8	12.0	12.0	12.0	25.0	13	3,45
101-09-1	5	9	13.0	12.0	13.0	25.0	15	3,45
101-10-1	5	10	14.0	12.0	12.6	25.0	21	3,45
101-11-1	5	11	16.0	12.0	14.0	25.0	24	3,45
101-12-1	5	12	17.0	12.0	14.8	25.0	26	3,45
101-13-1	5	13	18.0	12.0	15.8	25.0	28	3,45
101-14-1	5	14	20.0	12.0	17.4	25.0	39	3,45



R			A mm	B mm	C mm	L mm	g	€
101A-05-1	5	5/32"	6.9	8.5	12.0	25.0	10	3,51
101A-06-1	5	3/16"	7.5	8.5	12.0	25.0	10	3,51
101A-07-1	5	7/32"	8.8	9.5	12.0	25.0	11	3,51
101A-08-1	5	1/4"	9.4	9.5	12.0	25.0	11	3,51
101A-09-1	5	9/32"	11.0	10.5	12.0	25.0	13	3,51
101A-10-1	5	5/16"	12.0	10.5	12.0	25.0	12	3,51
101A-11-1	5	11/32"	13.0	10.5	12.0	25.0	14	3,51
101A-12-1	5	3/8"	14.0	10.5	12.6	25.0	18	3,51
101A-14-1	5	7/16"	16.0	11.5	14.0	25.0	23	3,51
101A-16-1	5	1/2"	18.0	11.5	15.8	25.0	29	3,51
101A-18-1	5	9/16"	20.0	11.5	17.4	25.0	37	3,51

VASOS 1/4" TORX®

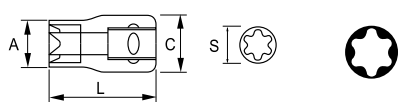

VASOS 1/4" HEX, SERIE LARGA

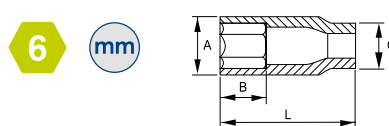

- Vasos en milímetros, diseño hexagonal
- Acero aleado Cromo Vanadio
- Acabado cromado brillante
- Perfil NPP
- DIN 3120

R			A mm	B mm	C mm	L mm	g	€
103-04-1	5	4	6.9	12.0	12.0	50.0	21	8,13
103-045-1	5	4.5	7.5	12.0	12.0	50.0	20	8,13
103-05-1	5	5	8.2	12.0	12.0	50.0	21	8,13
103-055-1	5	5.5	8.8	12.0	12.0	50.0	22	8,13
103-06-1	5	6	9.4	12.0	12.0	50.0	22	8,13
103-07-1	5	7	11.0	24.0	12.0	50.0	26	8,13
103-08-1	5	8	12.0	24.0	10.9	50.0	29	8,13
103-09-1	5	9	13.0	24.0	11.6	50.0	30	8,13
103-10-1	5	10	14.0	24.0	13.0	50.0	39	8,13
103-11-1	5	11	16.0	24.0	14.2	50.0	44	8,13
103-12-1	5	12	17.0	24.0	15.0	50.0	49	8,13
103-13-1	5	13	18.0	24.0	16.0	50.0	55	8,13
103-14-1	5	14	20.0	24.0	17.0	50.0	65	8,13



R			A mm	B mm	C mm	L mm	g	€
103A-06-1	5	3/16"	8.2	12.0	12.0	50.0	21	8,28
103A-08-1	5	1/4"	9.7	12.0	12.0	50.0	22	8,28
103A-09-1	5	9/32"	11.2	24.0	12.0	50.0	26	8,28
103A-10-1	5	5/16"	12.0	24.0	12.0	50.0	29	8,28
103A-11-1	5	11/32"	13.0	24.0	12.0	50.0	30	8,28
103A-12-1	5	3/8"	13.7	24.0	12.0	50.0	39	8,28
103A-14-1	5	7/16"	16.1	24.0	14.2	50.0	44	8,28
103A-16-1	5	1/2"	18.0	24.0	16.0	50.0	55	8,28

- Acero aleado Cromo Vanadio
- Acabado cromado brillante
- DIN 3120

R			S mm	A mm	B mm	L mm	g	€
106-04-1	5	E-4	3.8	6.0	12.0	25.0	10	3,68
106-05-1	5	E-5	4.7	7.0	12.0	25.0	11	3,68
106-06-1	5	E-6	5.7	8.0	12.0	25.0	11	3,68
106-07-1	5	E-7	6.2	8.6	12.0	25.0	11	3,68
106-08-1	5	E-8	7.5	10.3	12.0	25.0	12	3,68
106-10-1	5	E-10	9.4	12.3	13.0	25.0	21	3,68



VASOS CON PUNTA 1/4"

PUNTA PLANA



- Punta fabricada con acero especial S2
- DIN 3120

R			A mm	B mm	L mm	g	€
107-0840-1	5	0.8 x 4	11.8	20.0	37.5	15	3,13
107-1055-1	5	1 x 5.5	11.8	20.0	37.5	15	3,13
107-1280-1	5	1.2 x 8	11.8	20.0	37.5	16	3,13

PUNTA PHILLIPS



- Punta fabricada con acero especial S2
- DIN 3120

R			A mm	B mm	L mm	g	€
107-PH1-1	5	PH-1	11.8	20.0	37.5	15	3,27
107-PH2-1	5	PH-2	11.8	20.0	37.5	15	3,27
107-PH3-1	5	PH-3	11.8	20.0	37.5	16	3,27

PUNTA POZIDRIV



- Punta fabricada con acero especial S2
- DIN 3120

R			A mm	B mm	L mm	g	€
107-PZ1-1	5	PZ-1	11.8	20.0	37.5	15	3,27
107-PZ2-1	5	PZ-2	11.8	20.0	37.5	15	3,27
107-PZ3-1	5	PZ-3	11.8	20.0	37.5	16	3,27

PUNTA HEX



- Punta fabricada con acero especial S2
- DIN 3120

R			A mm	B mm	L mm	g	€
107-H3-1	5	3	11.8	20.0	37.5	15	3,00
107-H4-1	5	4	11.8	20.0	37.5	15	3,00
107-H5-1	5	5	11.8	20.0	37.5	16	3,00
107-H6-1	5	6	11.8	20.0	37.5	17	3,00
107-H8-1	5	8	11.8	20.0	37.5	19	3,00

R			A mm	B mm	L mm	g	€
107A-4-1	5	1/8"	11.8	20.0	37.5	15	3,04
107A-5-1	5	5/32"	11.8	20.0	37.5	15	3,04
107A-6-1	5	3/16"	11.8	20.0	37.5	16	3,04
107A-7-1	5	7/32"	11.8	20.0	37.5	17	3,04

PUNTA TORX®



- Punta fabricada con acero especial S2
- DIN 3120

R			S mm	A mm	C mm	L mm	g	€
107-T08-1	5	T8	2.3	11.8	20.0	37.5	15	3,89
107-T09-1	5	T9	2.5	11.8	20.0	37.5	15	3,89
107-T10-1	5	T10	2.7	11.8	20.0	37.5	15	3,89
107-T15-1	5	T15	3.3	11.8	20.0	37.5	15	3,89
107-T20-1	5	T20	3.8	11.8	20.0	37.5	15	3,89
107-T25-1	5	T25	4.4	11.8	20.0	37.5	15	4,01
107-T27-1	5	T27	5.0	11.8	20.0	37.5	16	4,01
107-T30-1	5	T30	5.5	11.8	20.0	37.5	16	4,01
107-T40-1	5	T40	6.6	11.8	20.0	37.5	16	4,01



ACCESORIOS 1/4"

CARRACA TIPO PERA

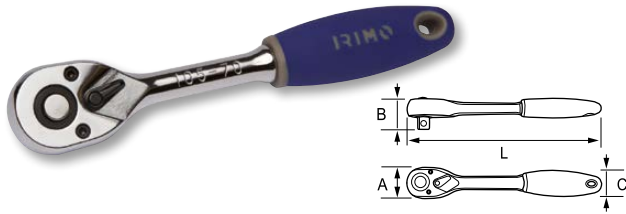

- 72 dientes / Ángulo de acción 5°
- Acabado cromado brillante
- Botón de rápida liberación
- Mango bicomponente
- DIN 3120, DIN 3122

R	📦	A mm	B mm	C mm	L mm	g	€
105-70-1	5	28	25	23	152	151	12,40

CARRACA REVERSIBLE REDONDA

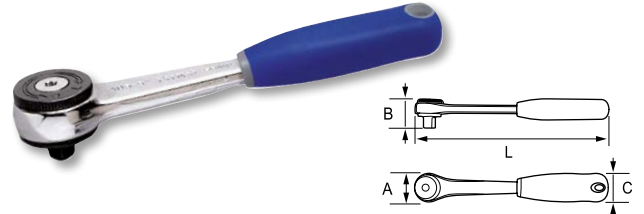

- 72 dientes / Ángulo de acción 5°
- Acabado cromado brillante
- DIN 3122/3120, ISO 3315, UNE 16512
- * Kit de reparación 105711

R	📦	A mm	B mm	C mm	L mm	g	€
105501	1	25	23	21	122	150	30,74

EXPOSITOR CON 12 CARRACAS DE 1/4"



- Carraca reversible
- 72 dientes / 5° de acción
- Acero de aleación de cromo vanadio
- Acabado cromado brillante
- Botón de rápida liberación
- Mango bicomponente
- Empuñadura acolchada de goma
- DIN 3122, DIN 3120
- Utilice el código 105-70-1 para hacer pedidos de carracas individuales

R	📦	📦	📏	g	€
105-70-12DISP	1	12	160 x 150 x 230	2.590	148,77

JUEGO DE VASOS 1/4" EN RAIL, 11 piezas



- Juego de vasos de 1/4"
- Juego de vasos 11 piezas
- Vasos hexagonales, medidas métricas
- Acabado brillante cromado
- DIN 3120, DIN 3124, DIN 3122
- Presentación para colgar

R	📦	📦	📏	g	€
109-11-4	5	11	232 x 60 x 15	250	40,08

101-04-1, 101-05-1, 101-06-1, 101-07-1, 101-08-1, 101-09-1, 101-10-1, 101-11-1, 101-12-1, 101-13-1, 101-14-1

JUEGO DE 1/4" CARRACA + 11 VASOS



- Juego de vasos 1/4", 13 piezas
- Vasos hexagonales, mm
- Acabado cromado brillante
- DIN 3120, DIN 3124, DIN 3122

* Suministrado en display si se piden 12 unidades

R	📦	📦	📏	g	€
109-13-4	8	13	254 x 70 x 30	460	30,36

105-70-1 105-24-1
 101-04-1, 101-05-1, 101-06-1, 101-07-1, 101-08-1, 101-09-1, 101-10-1, 101-11-1, 101-12-1, 101-13-1, 101-14-1



ALARGADERAS



• DIN 3120, DIN 3122

R		A mm	B mm	L mm	g	€
105-22-1	5	8.1	12.2	50	20	3,90
105-24-1	5	8.1	12.2	100	38	5,30
105-26-1	5	8.1	12.2	150	65	5,60

MANGO CORREDIZO EN T

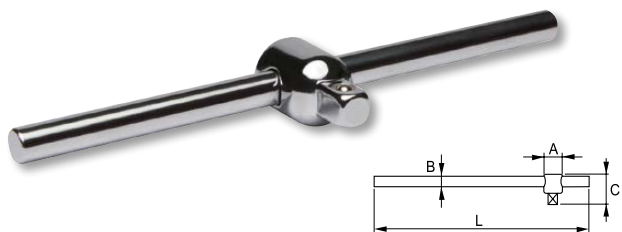

• DIN 3120, DIN 3122

R		A mm	B mm	C mm	L mm	g	€
105-42-1	5	13.5	6.0	24	115	45	6,85

MANGO CUADRADO MACHO

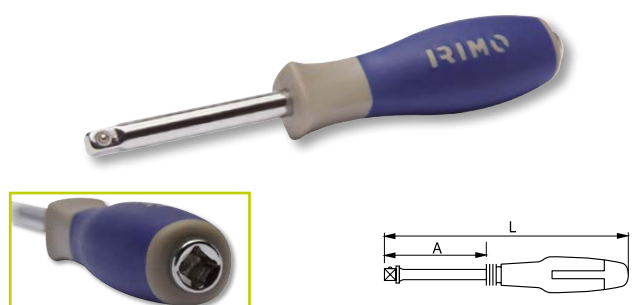

• Cuadrado hembra 1/4" en la cabeza
• DIN 3120

R		A mm	L mm			g	€
105-50-1	5	61	150	1/4"	1/4"	88	7,78

AUMENTADOR

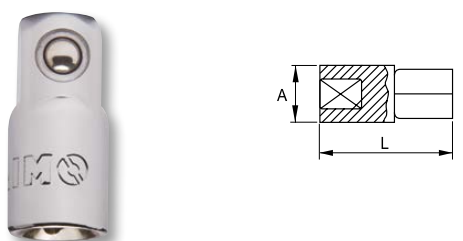

• Aumentador de 1/4" a 3/8"
• DIN 3120, DIN 3122

R		A mm	L mm	g	€
105-46-1	5	12.0	26.0	31	5,30

ALARGADERA FLEXIBLE

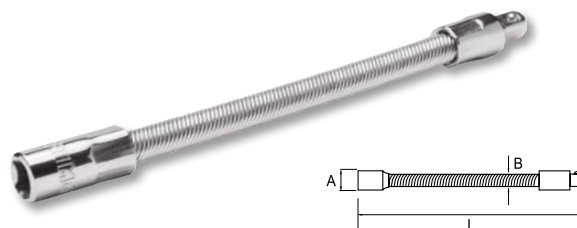

• DIN 3120

R		A mm	B mm	L mm	g	€
105-28-1	5	12.5	8	148	57	8,87

ARTICULACIÓN UNIVERSAL

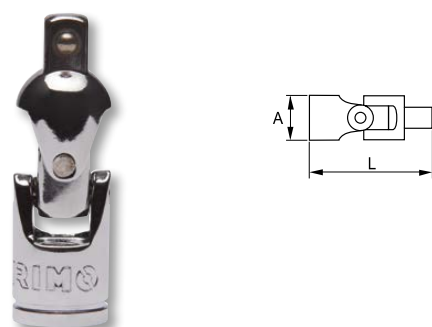

• DIN 3120, DIN 3122

R		A mm	L mm	g	€
105-40-1	5	13.8	38.0	27	10,01

VASO PORTA PUNTAS 1/4"



• Hembra cuadrado 1/4" a hembra hex 1/4"
• DIN 3120

R		A mm	L mm	g	€
105-48-1	5	11.9	25.0	12	4,12





JUEGO VASOS 1/4"

JUEGO DE VASOS Y PUNTAS DE 1/4", 23 piezas



- 23 vasos de 1/4" y conjunto de puntas DIN 3120 y DIN 3124
- Par de carraca según DIN 3122
- Carraca especial hexagonal de 1/4"; Reversible; 60 dientes; Longitud 90 mm
- Mango de carraca bi-material
- Caja de plástico ABS
- Incluye clip para el cinturón
- La carraca se vende como repuesto: SP121

109-23-4	1	23	110x75x45	340	€	30,28
101-06-1, 101-07-1, 101-08-1, 101-10-1, 101-11-1, 101-13-1						
475A-25-1						
475-PH1-1, 475-PH2-1						
475-PZ1-1, 475-PZ2-1						
475-4-1, 475-6.0-1						
475-H3-1, 475-H4-1, 475-H5-1, 475-H6-1						
475-T10-1, 475-T15-1, 475-T20-1, 475-T25-1, 475-T30-1						
SP121						

JUEGO VASOS 1/4", 35 piezas



- Juego vasos 35 piezas
- Vasos Hex mm
- Acabado cromado brillante
- DIN 3120, DIN 3124 y DIN 3122
- Caja fabricada en polietileno de alta densidad y resistente

JUEGO DE VASOS Y PUNTAS DE 1/4"



- Práctico juego de vaso y puntas hexagonales de 1/4", 37 piezas
- Portapuntas con sistema giratorio para un fácil acceso
- Práctica carraca reversible de 72 dientes. Longitud 105 mm
- Mangos bimateriales
- Acabado cromado brillante
- DIN 3120 y DIN 3124

109-37-4	1	37	45x100x150	780	€	35,00
x10		5.5-6-7-8-9-10-11-12-13-14 mm				
x1		1/4"		x2	1/4"	50-100 mm
x1		1/4"		x1	1/4"	
x22		1/4"				
(3x)	SL4-5-6	(3x)	PZ1-2-3			
(5x)	H3-4-5-6-7	(3x)	PH1-2-3			
(7x)	T10-15-20-25-27-30-40	(1x)	1/4"			

109-35-4	1	35	250 x 170 x 60	1.200	€	36,84
105-48-1		105-70-1				
105-42-1		105-50-1				
105-22-1		105-40-1				
105-24-1						
101-04-1, 101-045-1, 101-05-1, 101-055-1, 101-06-1, 101-07-1, 101-08-1, 101-09-1, 101-10-1, 101-11-1, 101-12-1, 101-13-1						
040001, 040011, 040021						
475-PH1-1, 475-PH2-1, 475-PH3-1						
475-PZ1-1, 475-PZ2-1, 475-PZ3-1						
475-4-1, 475-6.0-1						
475-H3-1, 475-H4-1, 475-H5-1, 475-H6-1						



JUEGO VASOS 1/4", 19 piezas



- Vasos Hex mm
- Acero aleado Cromo Vanadio
- Acabado cromado brillante
- DIN 3120, DIN 3124 y DIN 3122
- Caja fabricada en polietileno de alta densidad y resistente

R	10	19	260x185x55	g	€
109-19-4	10	19	260x185x55	1.100	36,03
105-40-1			105-70-1		
105-42-1			105-50-1		
105-22-1			105-26-1		
101-04-1, 101-045-1, 101-05-1, 101-055-1, 101-06-1, 101-07-1, 101-08-1, 101-09-1, 101-10-1, 101-11-1, 101-12-1, 101-13-1, 101-14-1					

VASOS 3/8"

VASOS 3/8" HEX

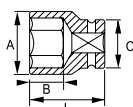

- Vasos en milímetros, diseño hexagonal
- Acero aleado Cromo Vanadio
- Acabado cromado brillante
- Perfil NPP
- DIN 3120, DIN 3124

R	5	A mm	B mm	C mm	L mm	g	€	
112-06-1	5	6	10.5	9.0	17.0	28.0	21	2,11
112-07-1	5	7	11.0	9.0	17.0	28.0	24	2,11
112-08-1	5	8	12.2	9.0	17.0	28.0	27	2,11
112-09-1	5	9	13.5	9.0	17.0	28.0	26	2,11
112-10-1	5	10	14.7	9.0	17.0	28.0	24	2,11
112-11-1	5	11	16.0	9.0	17.0	28.0	26	2,11
112-12-1	5	12	18.0	15.0	17.0	28.0	24	2,11
112-13-1	5	13	19.0	15.0	17.0	28.0	29	2,32
112-14-1	5	14	20.0	15.0	17.7	28.0	38	2,32
112-15-1	5	15	22.0	15.0	17.9	28.0	40	2,32
112-16-1	5	16	22.0	15.0	17.9	28.0	46	2,73
112-17-1	5	17	24.0	15.0	18.8	30.0	56	2,73
112-18-1	5	18	26.0	15.0	19.8	30.0	75	3,00
112-19-1	5	19	26.0	15.0	20.7	30.0	66	3,00
112-20-1	5	20	28.0	15.0	21.8	30.0	88	3,00
112-21-1	5	21	28.0	15.0	21.8	30.0	84	3,27
112-22-1	5	22	30.0	15.0	22.8	32.0	104	3,27

VASOS 3/8" HEX, SERIE LARGA

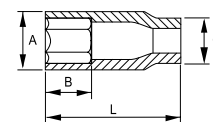

- Vasos en milímetros, diseño hexagonal
- Acero aleado Cromo Vanadio
- Acabado cromado brillante
- Perfil NPP
- DIN 3120

R	5	A mm	B mm	C mm	L mm	g	€	
113-07-1	5	7	11.0	16.0	17.0	64.0	45	6,54
113-08-1	5	8	12.2	16.0	17.0	64.0	49	6,54
113-09-1	5	9	13.5	16.0	17.0	64.0	53	6,54
113-10-1	5	10	14.7	16.0	17.0	64.0	60	6,54
113-11-1	5	11	17.0	29.0	16.0	64.0	61	6,54
113-12-1	5	12	18.0	29.0	17.2	64.0	63	6,94
113-13-1	5	13	19.0	29.0	16.8	64.0	75	6,94
113-14-1	5	14	20.0	29.0	17.8	64.0	81	6,94
113-16-1	5	16	22.0	29.0	18.0	64.0	98	6,94
113-17-1	5	17	24.0	29.0	18.9	64.0	123	8,18
113-19-1	5	19	26.0	29.0	20.8	64.0	145	8,18



ACCESORIOS 3/8"

CARRACA TIPO PERA

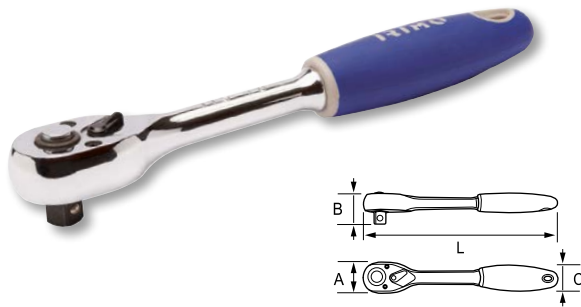

- 72 dientes / Ángulo de acción 5°
- Acabado cromado brillante
- Botón de rápida liberación
- Mango bicomponente
- DIN 3120, DIN 3122

R	📦	A mm	B mm	C mm	L mm	g	€
115-70-1	5	33	33	32	202	341	14,88

CARRACA REVERSIBLE REDONDA

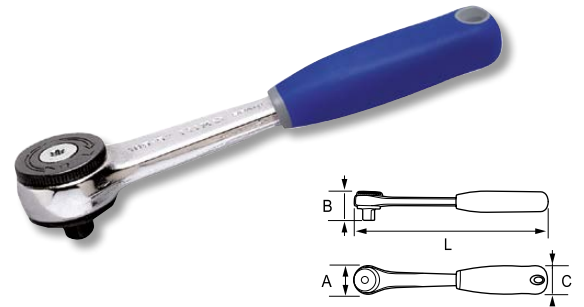

- 72 dientes / Ángulo de acción 5°
- Acabado cromado brillante
- DIN 3122, DIN 3120, ISO 3315, UNE 16512
- * Kit de reparación 115701

R	📦	A mm	B mm	C mm	L mm	g	€
115501	1	29	30	24	197	230	44,91

ALARGADERAS



- DIN 3120, DIN 3122

R	📦	A mm	B mm	L mm	g	€
115-20-1	5	17.0	12.1	75	125	4,11
115-22-1	5	17.0	12.1	150	138	5,60
115-24-1	5	17.0	12.1	250	232	5,92

MANGO CORREDIZO EN T

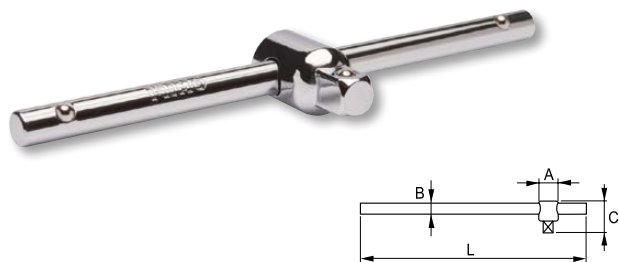

- DIN 3120, DIN 3122

R	📦	A mm	B mm	C mm	L mm	g	€
115-42-1	5	17.5	8.5	35	152	114	7,23

CABEZA MANGO CORREDIZO

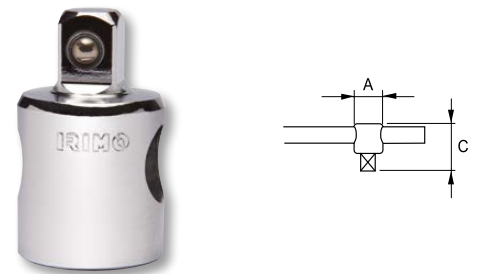

- DIN 3120

R	📦	A mm	C mm	g	€
115-43-1	5	24.0	40.5	30	5,30



ARTICULACIÓN UNIVERSAL



- DIN 3120, DIN 3122

Q	📦	A mm	L mm	g	€
115-40-1	5	17.8	59.0	61	10,58

REDUCTOR



- Adaptador reductor 3/8" a 1/4"
- DIN 3120

Q	📦	A mm	L mm	g	€
115-46-1	5	16.0	25.0	17	5,60

AUMENTADOR



- Aumentador de 3/8" a 1/2"
- DIN 3120

Q	📦	A mm	L mm	g	€
115-44-1	5	18.0	35.5	45	7,23

VASO PORTA PUNTAS



- Hembra cuadrado 3/8" a hembra hex 5/16"
- DIN 3120

Q	📦	🌀	A mm	L mm	g	€
115-48-1	5	5/16"	15.4	28.0	24	4,35

JUEGO VASOS 3/8"

JUEGO VASOS 3/8", 18 piezas



- Juego vasos 18 piezas
- Vasos Hex mm
- Acabado cromado brillante
- DIN 3120, DIN 3124 y DIN 3122
- Caja fabricada en polietileno de alta densidad y resistente

Q	📦	📦	📏	g	€
119-18-4	1	18	320 x 250 x 75	3.250	45,78

112-07-1, 112-08-1, 112-10-1, 112-11-1, 112-12-1, 112-13-1, 112-14-1, 112-15-1, 112-16-1, 112-17-1, 112-19-1, 112-21-1, 112-22-1	3/8"	
--	------	--

115-70-1	
----------	--

115-20-1, 115-22-1	
--------------------	--

115-40-1	
----------	--

115-43-1	
----------	--



VASOS 1/2"

VASOS 1/2" HEX

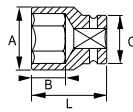

- Vasos en milímetros, diseño hexagonal
- Acero aleado Cromo Vanadio
- Acabado cromado brillante
- Perfil NPP
- DIN 3120, DIN 3124

R			A mm	B mm	C mm	L mm	g	€
121-08-1	5	8	14.8	13.0	22.0	38.0	50	3,49
121-09-1	5	9	15.3	13.0	22.0	38.0	48	3,49
121-10-1	5	10	15.3	13.0	22.0	38.0	49	3,46
121-11-1	5	11	16.5	13.0	22.0	38.0	50	3,52
121-12-1	5	12	17.8	13.0	22.0	38.0	52	3,78
121-13-1	5	13	19.0	13.0	22.0	38.0	54	3,93
121-14-1	5	14	20.3	13.0	22.0	38.0	56	4,16
121-15-1	5	15	22.0	17.8	20.5	38.0	57	4,23
121-16-1	5	16	22.0	17.8	20.5	38.0	71	4,41
121-17-1	5	17	24.0	17.8	21.9	38.0	72	4,52
121-18-1	5	18	25.0	17.8	22.9	38.0	90	4,52
121-19-1	5	19	26.0	17.8	22.9	38.0	84	4,76
121-20-1	5	20	28.0	17.8	23.9	38.0	87	4,83
121-21-1	5	21	28.0	17.8	23.9	38.0	95	5,01
121-22-1	5	22	30.0	17.8	26.1	38.0	97	5,18
121-23-1	5	23	32.0	17.8	28.1	38.0	103	5,41
121-24-1	5	24	32.0	17.8	28.1	38.0	109	5,76
121-25-1	5	25	34.0	17.8	29.1	40.0	146	5,84
121-26-1	5	26	34.0	17.8	29.1	42.0	192	5,98
121-27-1	5	27	36.0	17.8	30.1	42.0	211	6,23
121-28-1	5	28	38.0	17.8	32.1	42.0	212	6,61
121-30-1	5	30	40.0	17.8	34.1	44.0	214	6,91
121-32-1	5	32	42.0	17.8	36.1	44.0	217	7,10
121-34-1	5	34	50.0	18.0	38.0	44.0	260	9,17
121-36-1	5	36	52.0	18.2	40.0	45.0	300	12,90

VASOS 1/2" BIHEX

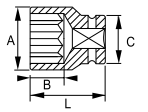

- Vasos en milímetros, diseño bi-hexagonal
- Acero aleado Cromo Vanadio
- Acabado cromado brillante
- Perfil NPP
- DIN 3120, DIN 3124

R			A mm	B mm	C mm	L mm	g	€
122-08-1	5	8	14.8	13.0	22.0	38.0	50	3,49
122-09-1	5	9	15.3	13.0	22.0	38.0	48	3,49
122-10-1	5	10	15.3	13.0	22.0	38.0	49	3,46
122-11-1	5	11	16.5	13.0	22.0	38.0	50	3,52
122-12-1	5	12	17.8	13.0	22.0	38.0	52	3,78
122-13-1	5	13	19.0	13.0	22.0	38.0	54	3,93
122-14-1	5	14	20.3	13.0	22.0	38.0	56	4,16
122-15-1	5	15	22.0	17.8	20.5	38.0	57	4,23
122-16-1	5	16	22.0	17.8	20.5	38.0	71	4,41
122-17-1	5	17	24.0	17.8	21.9	38.0	72	4,52
122-18-1	5	18	25.0	17.8	22.9	38.0	90	4,52
122-19-1	5	19	26.0	17.8	22.9	38.0	84	4,76
122-20-1	5	20	28.0	17.8	23.9	38.0	87	4,83
122-21-1	5	21	28.0	17.8	23.9	38.0	95	5,01
122-22-1	5	22	30.0	17.8	26.1	38.0	97	5,18
122-23-1	5	23	32.0	17.8	28.1	38.0	103	5,41
122-24-1	5	24	32.0	17.8	28.1	38.0	109	5,76
122-27-1	5	27	36.0	17.8	30.1	42.0	211	6,23
122-30-1	5	30	40.0	17.8	34.1	44.0	214	6,91
122-32-1	5	32	42.0	17.8	36.1	44.0	217	7,10
122-34-1	5	34	44.0	17.8	37.1	45.0	220	9,17
122-36-1	5	36	44.0	17.8	38.1	44.0	220	12,90



R			A mm	B mm	C mm	L mm	g	€
122A-10-1	5	5/16"	14.8	13.0	22.0	38.0	50	3,52
122A-11-1	5	11/32"	15.3	13.0	22.0	38.0	48	3,54
122A-12-1	5	3/8"	15.5	13.0	22.0	38.0	45	3,57
122A-14-1	5	7/16"	16.7	13.0	22.0	38.0	49	3,68
122A-16-1	5	1/2"	19.2	13.0	22.0	38.0	54	4,02
122A-18-1	5	9/16"	20.5	13.0	22.0	38.0	55	4,26
122A-20-1	5	5/8"	22.0	17.8	20.6	38.0	69	4,52
122A-22-1	5	11/16"	24.0	17.8	21.9	38.0	71	4,71
122A-24-1	5	3/4"	26.0	17.8	22.9	38.0	75	4,91
122A-26-1	5	13/16"	28.0	17.8	23.9	38.0	76	5,15
122A-28-1	5	7/8"	30.0	17.8	26.1	38.0	88	5,36
122A-30-1	5	15/16"	32.0	17.8	28.1	38.0	104	5,98
122A-34-1	5	1.1/16"	36.0	17.8	30.1	42.0	141	6,44
122A-38-1	5	1.3/16"	40.0	17.8	34.1	44.0	214	7,13
122A-40-1	5	1.1/4"	42.0	17.8	36.1	44.0	233	7,30



VASOS 1/2" BIHEX, SERIE LARGA

12 mm

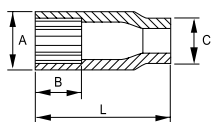

- Vasos en milímetros, diseño bi-hexagonal
- Acero aleado Cromo Vanadio
- Acabado cromado brillante
- Perfil NPP
- DIN 3120, DIN 3124

Q	Box	mm	A mm	B mm	C mm	L mm	g	€
124-10-1	5	10	15.3	27.0	22.0	78.0	78	9,59
124-11-1	5	11	16.5	27.0	22.0	78.0	86	9,67
124-12-1	5	12	17.8	27.0	22.0	78.0	103	9,67
124-13-1	5	13	19.0	27.0	22.0	78.0	108	9,85
124-14-1	5	14	20.3	27.0	22.0	78.0	109	10,45
124-15-1	5	15	22.0	31.0	22.0	78.0	113	10,45
124-16-1	5	16	22.0	31.0	22.0	78.0	115	10,45
124-17-1	5	17	24.0	31.0	22.0	78.0	123	10,45
124-18-1	5	18	25.0	31.0	22.8	78.0	149	10,45
124-19-1	5	19	26.0	31.0	22.8	78.0	135	10,45
124-21-1	5	21	28.0	31.0	23.8	78.0	151	10,71
124-22-1	5	22	30.0	31.0	26.0	78.0	190	15,03
124-24-1	5	24	32.0	31.0	28.0	78.0	220	15,11
124-27-1	5	27	36.0	31.0	30.0	78.0	250	15,38
124-30-1	5	30	40.0	31.0	34.0	78.0	341	16,66
124-32-1	5	32	42.0	31.0	36.0	78.0	382	19,78

12 in

Q	Box	in	A mm	B mm	C mm	L mm	g	€
124A-18-1	5	9/16"	22.0	31.0	22.0	78.0	113	10,66
124A-20-1	5	5/8"	22.0	31.0	22.0	78.0	115	10,66
124A-22-1	5	11/16"	25.0	31.0	22.8	78.0	149	10,88
124A-24-1	5	3/4"	26.0	31.0	22.8	78.0	135	15,33
124A-26-1	5	13/16"	28.0	31.0	23.8	78.0	151	15,42

VASOS 1/2" TORX®

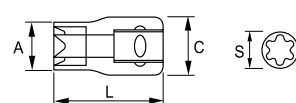

- DIN 3120

Q	Box	mm	S mm	A mm	C mm	L mm	g	€
126-10-1	5	E-10	9.4	14.7	22.0	38.0	55	5,48
126-11-1	5	E-11	10.0	15.2	22.0	38.0	53	5,48
126-12-1	5	E-12	11.1	16.0	22.0	38.0	57	5,65
126-14-1	5	E-14	12.9	17.0	22.0	38.0	59	5,65
126-16-1	5	E-16	14.7	22.0	20.1	38.0	65	5,76
126-18-1	5	E-18	16.6	24.0	21.8	38.0	77	5,76
126-20-1	5	E-20	18.4	24.0	21.8	38.0	73	5,98
126-24-1	5	E-24	22.1	28.0	23.8	38.0	110	6,65





VASOS CON PUNTA 1/2"

PUNTA HEX



• DIN 3120 / ISO 1174

€			A mm	B mm	L mm	g	€
180-04-1	5	4	21.8	22	60	70	8,63
180-05-1	5	5	21.8	22	60	71	8,63
180-06-1	5	6	21.8	22	60	72	8,63
180-07-1	5	7	21.8	22	60	72	8,98
180-08-1	5	8	21.8	22	60	73	8,98
180-10-1	5	10	21.8	22	60	81	8,98
180-12-1	5	12	21.8	22	60	89	9,85
180-14-1	5	14	21.8	22	60	96	9,85
180-17-1	5	17	23.8	22	60	100	11,65
180-19-1	5	19	23.8	22	60	100	16,70

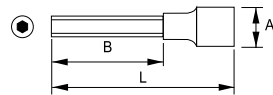

€			A mm	B mm	L mm	g	€
180-05X-1	5	5	21.8	62	100	89	9,59
180-06X-1	5	6	21.8	62	100	90	9,59
180-07X-1	5	7	21.8	62	100	91	9,85
180-08X-1	5	8	21.8	62	100	91	9,85
180-10X-1	5	10	21.8	62	100	109	9,85
180-12X-1	5	12	21.8	62	100	130	11,65

JUEGO 9 VASOS CON PUNTA 1/2" HEXAGONAL



- Juego de vasos con punta 1/2", 9 piezas
- Puntas hexagonales, mm
- Vasos: Acabado cromado brillante
- Puntas: fosfatadas
- DIN 3120 / ISO 1174
- Caja fabricada en polietileno de alta densidad y resistente

€				g	€
129-9H-4	1	9	55 x 200 x 160	1.080	42,31

180-04-1, 180-05-1, 180-06-1, 180-07-1, 180-08-1, 180-10-1, 180-12-1, 180-14-1, 180-17-1

PUNTA TORX®



• DIN 3120 / ISO 1174

€			S mm	A mm	B mm	L mm	g	€
183-20-1	5	T20	3.84	21.8	22	60	69	9,25
183-25-1	5	T25	4.40	21.8	22	60	69	9,25
183-27-1	5	T27	4.96	21.8	22	60	70	9,25
183-30-1	5	T30	5.49	21.8	22	60	70	9,25
183-40-1	5	T40	6.60	21.8	22	60	70	9,32
183-45-1	5	T45	7.77	21.8	22	60	70	9,32
183-50-1	5	T50	8.79	21.8	22	60	71	9,32
183-55-1	5	T55	11.17	21.8	22	60	76	11,82
183-60-1	5	T60	13.20	21.8	22	60	81	12,18

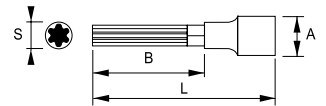

€			S mm	A mm	B mm	L mm	g	€
183-40X-1	5	T40	6.60	21.8	82	120	95	10,19
183-45X-1	5	T45	7.77	21.8	82	120	96	10,19
183-50X-1	5	T50	8.79	21.8	82	120	98	10,19
183-55X-1	5	T55	11.17	21.8	102	140	117	16,85

JUEGO 9 VASOS CON PUNTA TORX® 1/2"



- Juego de vasos con punta 1/2", 9 piezas
- Puntas TORX®
- Vasos: Acabado cromado brillante
- Puntas: fosfatadas
- DIN 3120 / ISO 1174
- Caja fabricada en polietileno de alta densidad y resistente

€				g	€
129-9T-4	1	9	55 x 200 x 160	1.140	43,38

183-20-1, 183-25-1, 183-27-1, 183-30-1, 183-40-1, 183-45-1, 183-50-1, 183-55-1, 183-60-1



PUNTA XZN

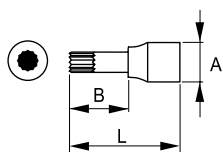

• DIN 3120 / ISO 1174

Q	Box	Tip	A mm	B mm	L mm	g	€
185-05-1	5	M 5	21.8	22	60	67	10,71
185-06-1	5	M 6	21.8	22	60	69	10,71
185-08-1	5	M 8	21.8	22	60	69	10,71
185-10-1	5	M 10	21.8	22	60	77	10,89
185-12-1	5	M 12	21.8	22	60	85	11,65
185-14-1	5	M 14	21.8	22	60	90	11,65
185-16-1	5	M 16	21.8	22	60	95	13,91

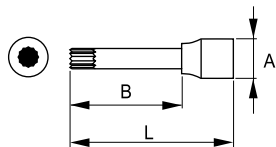

Q	Box	Tip	A mm	B mm	L mm	g	€
185-06X-1	5	M 6	21.8	62	100	87	10,89
185-08X-1	5	M 8	21.8	62	100	89	10,89
185-10X-1	5	M 10	21.8	62	100	105	11,65
185-12X-1	5	M 12	21.8	62	100	123	13,30

ACCESORIOS 1/2"

CARRACA TIPO PERA

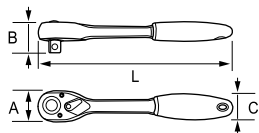

- 72 dientes / Ángulo de acción 5°
- Acabado cromado brillante
- Botón de rápida liberación
- Mango bicomponente
- DIN 3122/3120

Q	Box	A mm	B mm	C mm	L mm	g	€
125-70-1	5	42	41	36	262	591	17,44

VASOS 1/2" CON PUNTA TORX® INVOLABLE

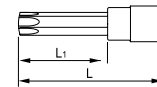

- Vasos con punta 1/2" TORX® inviolable
- Acabado zinc fosfatado
- Envase individual

Q	Box	Tip	Size	L mm	L1 mm	g	€
T49T30XL	1	TR30	1/2"	200	160	122	10,06
T49T40XL	1	TR40	1/2"	200	160	123	10,06
T49T45XL	1	TR45	1/2"	200	160	125	10,06
T49T70HL	1	TR70	1/2"	100	60	167	18,01
T49T80HL	1	TR80	1/2"	100	30	163	18,01

CARRACA REVERSIBLE REDONDA

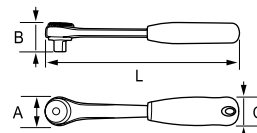

- 72 dientes / Ángulo de acción 5°
- Acabado cromado brillante
- DIN 3122, DIN 3120, ISO 3315, UNE 16512
- * Kit de reparación 125701

Q	Box	A mm	B mm	C mm	L mm	g	€
125501	1	39	41	30	251	614	50,74



ACCESORIOS 1/2"

EXPOSITOR CON 12 CARRACAS DE 1/2"



- Carraca reversible
- 72 dientes / 5° de acción
- Acero de aleación de cromo vanadio
- Acabado cromado brillante
- Botón de rápida liberación
- Mango bicomponente
- Empuñadura acolchada de goma
- DIN 3122, DIN 3120
- Utilice el código 125-70-1 para hacer pedidos de carracas individuales

€					€
125-70-12DISP	1	12	225 x 295 x 220	7.852	209,33

JUEGO DE VASOS 1/2" EN RAIL, 10 piezas



- Juego de vasos de 1/2"
- Juego de vasos 10 piezas
- Vasos hexagonales, medidas métricas
- Acabado brillante cromado
- DIN 3120, DIN 3124, DIN 3122
- Presentación para colgar

€					€
129-10-4	5	10	360 x 90 x 15	800	42,41

121-10-1, 121-12-1, 121-13-1, 121-14-1, 121-16-1, 121-17-1, 121-19-1, 121-21-1, 121-22-1, 121-24-1

JUEGO DE 1/2" CARRACA + 10 VASOS



- Juego de vasos 12 piezas
- Vasos hexagonales, mm
- Acabado cromado brillante
- DIN 3120, DIN 3124, DIN 3122
- * Suministrado en display si se piden 8 unidades

€					€
129-12-4	8	12	330 x 100 x 50	1.600	42,00

125-70-1 125-23-1
 121-10-1, 121-12-1, 121-13-1, 121-14-1, 121-16-1, 121-17-1, 121-19-1, 121-21-1, 121-22-1, 121-24-1

ALARGADERAS

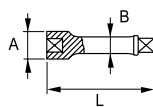

- DIN 3120, DIN 3122

€		A mm	B mm	L mm		€
125-22-1	5	22.4	15.7	75	120	7,74
125-23-1	5	22.4	15.7	125	193	8,13
125-25-1	5	22.4	15.7	250	380	10,01

MANGO ARTICULADO

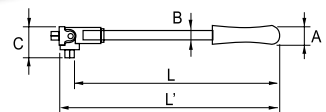
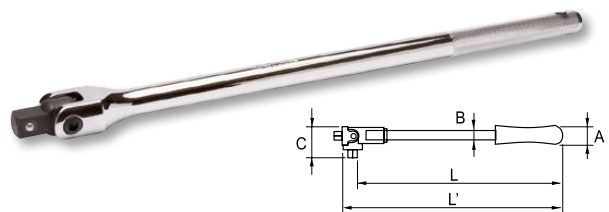

- DIN 3120

€		A mm	B mm	C mm	L' mm	L mm		€
125-52-1	5	35	12	40	375	355.0	692	26,59



BERBIQUÍ

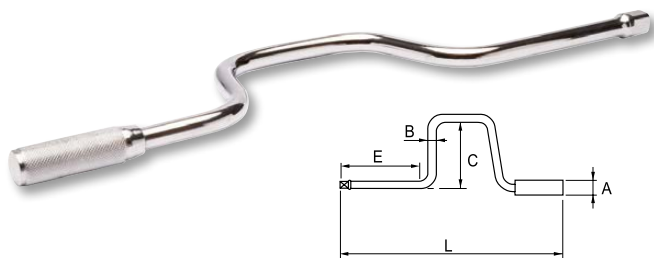

• DIN 3120, DIN 3122

Q	📦	A mm	B mm	C mm	E mm	L mm	g	€
125-49-1	5	31.0	12.7	75	152	420	575	18,48

MANGO CORREDIZO EN T



• DIN 3120, DIN 3122

Q	📦	A mm	B mm	C mm	L mm	g	€
125-42-1	5	23.5	13.5	45	250	272	13,40

CABEZA MANGO CORREDIZO

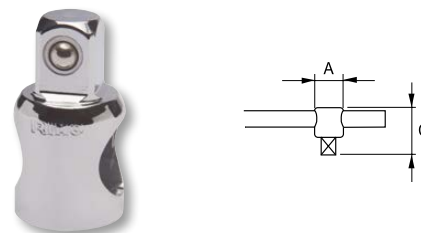

• DIN 3120

Q	📦	A mm	C mm	g	€
125-43-1	5	24.0	44	73	6,36

REDUCTOR



• Adaptador reductor 1/2" a 3/8"
• DIN 3120, DIN 3122

Q	📦	A mm	L mm	g	€
125-46-1	5	22.0	35.5	45	9,16

AUMENTADOR



• Aumentador de 1/2" a 3/4"
• DIN 3120, DIN 3122

Q	📦	A mm	L mm	g	€
125-44-1	5	25.0	50.0	140	11,05

MANGO ACODADO

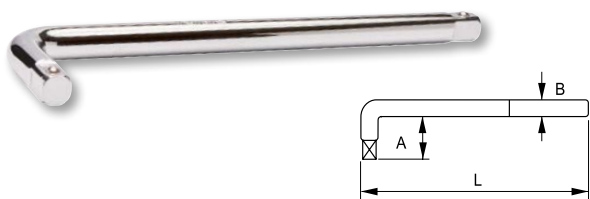

• DIN 3120, DIN 3122

Q	📦	A mm	B mm	L mm	g	€
125-60-1	5	46	14	250	456	9,85

VASO PARA BUJÍAS

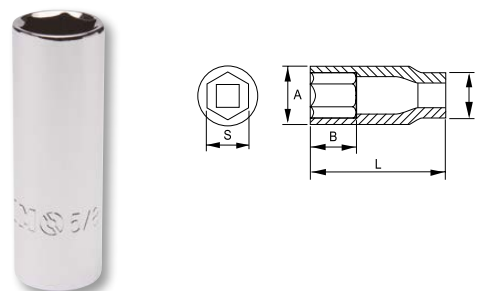

Q	📦	S mm	A mm	B mm	C mm	L mm	g	€
125-53-1	5	5/8" - 16	22.0	32.0	22.0	65.0	90	8,88
125-54-1	5	13/16" - 21	28.0	31.0	24.0	65.0	146	11,15





ACCESORIOS 1/2"

ARTICULACIÓN UNIVERSAL



- DIN 3120, DIN 3122

R	📦	A mm	L mm	g	€
125-40-1	5	23.8	72.0	146	17,28

VASO PORTA PUNTAS 5/16"



- Cuadrado hembra 1/2" a hex hembra 5/16"
- DIN 3120

R	📦	🌀	A mm	L mm	g	€
125-48-1	5	5/16"	17.0	38.5	56	5,82

JUEGO VASOS 1/2"

JUEGO VASOS 1/2", 23 piezas



- Juego de vasos 23 piezas
- Vasos Hex mm
- Acabado cromado brillante
- DIN 3120, DIN 3124 y DIN 3122
- Caja fabricada en polietileno de alta densidad y resistente
- Cierres metálicos

R	📦	📦	📦	g	€
129-23-4	1	23	320x250x75	3.500	78,95

125-70-1		125-43-1	
125-25-1		125-23-1	
125-40-1			
121-08-1, 121-10-1, 121-12-1, 121-13-1, 121-14-1, 121-16-1, 121-17-1, 121-19-1, 121-20-1, 121-21-1, 121-22-1, 121-23-1, 121-24-1, 121-26-1, 121-27-1, 121-28-1, 121-30-1, 121-32-1			

JUEGO DE VASOS Y LLAVES 1/2", 33 piezas



- Juego de vasos y llaves de 33 piezas
- Vasos hexagonales, mm
- Acabado cromado brillante
- DIN 3120, DIN 3124, DIN 3122, ISO 10102
- Caja fabricada en polietileno de alta densidad y resistente
- Caja con cierres metálicos

R	📦	📦	📦	g	€
129-33W-4	1	33	320x250x75	5.020	105,76

125-70-1		125-43-1	
125-25-1		125-23-1	
125-40-1			
25-08-1, 25-09-1, 25-10-1, 25-11-1, 25-12-1, 25-13-1, 25-14-1, 25-15-1, 25-17-1, 25-19-1			
121-08-1, 121-10-1, 121-12-1, 121-13-1, 121-14-1, 121-16-1, 121-17-1, 121-19-1, 121-20-1, 121-21-1, 121-22-1, 121-23-1, 121-24-1, 121-26-1, 121-27-1, 121-28-1, 121-30-1, 121-32-1			



**JUEGO VASOS MIXTO 1/4"-1/2",
58 piezas**



- Juego de vasos 58 piezas
- Vasos Hex mm
- Acabado cromado brillante
- DIN 3120, DIN 3124 y DIN 3122
- Caja fabricada en polietileno de alta densidad y resistente
- Cierres metálicos

Part Number	Quantity	Dimensions	Weight	Price
129-58-4	1	58	380x280x80	4.750 102,23
105-50-1		105-70-1		
105-42-1		105-40-1		
105-22-1		105-24-1		
125-70-1		125-43-1		
125-25-1		125-40-1		
125-23-1				
101-04-1, 101-045-1, 101-05-1, 101-055-1, 101-06-1, 101-07-1, 101-08-1, 101-09-1, 101-10-1, 101-11-1, 101-12-1, 101-13-1		1/4"		
121-08-1, 121-10-1, 121-12-1, 121-13-1, 121-14-1, 121-16-1, 121-17-1, 121-19-1, 121-20-1, 121-21-1, 121-22-1, 121-23-1, 121-24-1, 121-26-1, 121-27-1, 121-28-1, 121-30-1, 121-32-1		1/2"		
040001, 040011, 040021				
475-PH1-1, 475-PH2-1, 475-PH3-1				
475-PZ1-1, 475-PZ2-1, 475-PZ3-1				
475-3-1, 475-4-1, 475-5.5-1				
475-H3-1, 475-H4-1, 475-H5-1, 475-H6-1				

**JUEGO VASOS MIXTO 1/4"-1/2",
HEXAGONALES, 53 piezas**



- Juego de vasos, 53 piezas
- Vasos hexagonales, mm
- Acabado cromado brillante
- DIN 3120, DIN 3124, DIN 3122
- Caja fabricada en polietileno de alta densidad y resistente
- Caja con cierres metálicos

Part Number	Quantity	Dimensions	Weight	Price
129A-53-4	1	53	380x280x80	4.750 102,48
105-48-1		105-70-1		
105-42-1		105-50-1		
105-22-1		105-24-1		
105-40-1		125-70-1		
125-25-1		125-43-1		
125-23-1		125-40-1		
101A-05-1, 101A-06-1, 101A-07-1, 101A-08-1, 101A-09-1, 101A-10-1, 101A-11-1, 101A-12-1, 101A-14-1, 101A-16-1, 101A-18-1		1/4"		
122A-10-1, 122A-11-1, 122A-12-1, 122A-14-1, 122A-16-1, 122A-18-1, 122A-20-1, 122A-22-1, 122A-24-1, 122A-26-1, 122A-28-1, 122A-30-1, 122A-34-1, 122A-38-1, 122A-40-1		1/2"		
040001, 040011, 040021				
475-PH1-1, 475-PH2-1, 475-PH3-1				
475-PZ1-1, 475-PZ2-1, 475-PZ3-1				
475-3-1, 475-4-1, 475-5.5-1				
1/4" Hex 1/8", 5/32", 3/16", 7/32" AF				





JUEGO VASOS 1/2"

JUEGO VASOS MIXTO 1/4"-1/2", 108 piezas



- Juego de vasos de 108 piezas
- Vasos hexagonales, mm
- Acabado cromado brillante
- DIN 3120, DIN 3124, DIN 3122
- Caja fabricada en polietileno de alta densidad y resistente
- Caja con cierres metálicos

R	📦	📦	📦	📦	€
129-108-4	1	108	380x280x80	7.100	144,89
105-48-1		105-70-1			
125-42-1		105-50-1			
105-22-1		105-40-1			
105-24-1		125-70-1			
125-48-1		125-43-1			
125-25-1		125-23-1			
125-40-1					
101-04-1, 101-045-1, 101-05-1, 101-055-1, 101-06-1, 101-07-1, 101-08-1, 101-09-1, 101-10-1, 101-11-1, 101-12-1, 101-13-1, 101-14-1		1/4"			
103-06-1, 103-07-1, 103-08-1, 103-09-1, 103-10-1, 103-12-1, 103-13-1		1/4"			
106-04-1, 106-05-1, 106-06-1, 106-07-1, 106-08-1					
121-10-1, 121-11-1, 121-12-1, 121-13-1, 121-14-1, 121-15-1, 121-16-1, 121-17-1, 121-18-1, 121-19-1, 121-20-1, 121-21-1, 121-22-1, 121-24-1, 121-27-1, 121-30-1, 121-32-1		1/2"			
126-10-1, 126-11-1, 126-12-1, 126-14-1, 126-16-1, 126-18-1, 126-20-1, 126-24-1					
124-14-1, 124-15-1, 124-17-1, 124-19-1, 124-22-1		1/2"			
125-53-1, 125-54-1					
107-T08-1, 107-T10-1, 107-T15-1, 107-T20-1, 107-T25-1, 107-T27-1, 107-T30-1					
107-H3-1, 107-H4-1, 107-H5-1, 107-H6-1					
107-PH1-1, 107-PH2-1					
107-PZ1-1, 107-PZ2-1					
107-0840-1, 107-1055-1, 107-1280-1					
040001, 040011, 040021					
045801, 045811, 045821					
470-10.0-1, 470-12.0-1, 470-8.0-1					
470-H10-1, 470-H7-1, 470-H8-1					
470-PH3-1, 470-PH4-1					
470-T40-1, 470-T45-1, 470-T50-1, 470-T55-1, 470-T60-1					
470-PZ3-1, 470-PZ4-1					

JUEGO VASOS MIXTO 1/4"-1/2", HEXAGONALES, 103 piezas



- Juego de vasos, 103 piezas
- Vasos hexagonales, pulgadas
- Acabado cromado brillante
- DIN 3120, DIN 3124, DIN 3122
- Caja fabricada en polietileno de alta densidad y resistente
- Caja con cierres metálicos

R	📦	📦	📦	📦	€
129A-103-4	1	103	380x280x80	7.000	147,14
105-40-1		105-70-1			
105-42-1		105-50-1			
105-22-1		105-24-1			
125-70-1		125-43-1			
125-25-1		125-40-1			
125-23-1		125-48-1			
101A-05-1, 101A-06-1, 101A-07-1, 101A-08-1, 101A-10-1, 101A-11-1, 101A-12-1, 101A-14-1, 101A-16-1, 101A-18-1		1/4"			
103A-06-1, 103A-08-1, 103A-09-1, 103A-10-1, 103A-11-1, 103A-12-1, 103A-14-1, 103A-16-1		1/4"			
106-04-1, 106-05-1, 106-06-1, 106-07-1, 106-08-1					
122A-12-1, 122A-14-1, 122A-16-1, 122A-18-1, 122A-20-1, 122A-22-1, 122A-24-1, 122A-26-1, 122A-28-1, 122A-40-1		1/2"			
124A-18-1, 124A-20-1, 124A-22-1, 124A-24-1, 124A-26-1		1/2"			
126-10-1, 126-11-1, 126-12-1, 126-14-1, 126-16-1, 126-18-1, 126-20-1, 126-24-1					
125-53-1, 125-54-1					
107-T08-1, 107-T09-1, 107-T10-1, 107-T15-1, 107-T20-1, 107-T25-1, 107-T27-1, 107-T30-1					
107A-4-1, 107A-5-1, 107A-6-1, 107A-7-1					
107-PH1-1, 107-PH2-1					
107-PZ1-1, 107-PZ2-1					
107-0840-1, 107-1055-1, 107-1280-1					
040001, 040011, 040021					
470-T40-1, 470-T45-1, 470-T50-1, 470-T55-1, 470-T60-1					
470-10.0-1, 470-12.0-1, 470-8.0-1					
470-H7-1, 470-H8-1, 470-H10-1, 470-H12-1, 470-H14-1					
470-PH3-1, 470-PH4-1					
470-PZ3-1, 470-PZ4-1					



**JUEGO VASOS MIXTO 1/4"-1/2",
101 piezas**



- Juego de vasos 101 piezas
- Vasos Hex mm
- Acabado cromado brillante
- DIN 3120, DIN 3124 y DIN 3122
- Caja fabricada en polietileno de alta densidad y resistente
- Caja con cierres metálicos

Artículo	Cantidad	Medida	Peso	Precio
129-101-4	1	101	380x280x80	7.000 €
105-48-1		105-70-1		
125-42-1		105-50-1		
105-22-1		105-40-1		
105-24-1		105-28-1		
125-70-1		125-43-1		
125-25-1		125-40-1		
125-23-1		125-48-1		
101-04-1, 101-045-1, 101-05-1, 101-055-1, 101-06-1, 101-07-1, 101-08-1, 101-09-1, 101-10-1, 101-11-1, 101-12-1, 101-13-1, 101-14-1				1/4"
103-06-1, 103-07-1, 103-08-1, 103-10-1, 103-11-1, 103-12-1, 103-13-1, 103-14-1				1/4"
121-08-1, 121-10-1, 121-12-1, 121-13-1, 121-14-1, 121-16-1, 121-17-1, 121-19-1, 121-20-1, 121-21-1, 121-22-1, 121-23-1, 121-24-1, 121-26-1, 121-27-1, 121-28-1, 121-30-1, 121-32-1				1/2"
124-13-1, 124-17-1, 124-19-1, 124-22-1				1/2"
107-T08-1, 107-T10-1, 107-T15-1, 107-T20-1, 107-T25-1, 107-T30-1				
107-H3-1, 107-H 4-1, 107-H5-1, 107-H6-1				
107-PH1-1, 107-PH2-1				
107-PZ1-1, 107-PZ2-1				
107-0840-1, 107-1055-1, 107-1280-1				
040001, 040011, 040021				
475-H3-1, 475-H4-1, 475-H5-1				
475-T10-1, 475-T15-1, 475-T20-1, 475-T25-1, 475-T27-1, 475-T30-1				
470-8.0-1, 470-10.0-1				
470-H6-1, 470-H7-1, 470-H8-1, 470-H10-1				
470-T30-1, 470-T40-1, 470-T45-1, 470-T50-1, 470-T55-1				

**JUEGO VASOS 1/4" - 3/8" - 1/2"
HEXAGONALES, MM, 172 piezas**



- Vasos hexagonales, mm
- Acabado cromado brillante
- DIN 3120, DIN 3124, DIN 3122
- Caja fabricada en polietileno de alta densidad y resistente
- Caja con cierres metálicos

Artículo	Cantidad	Medida	Peso	Precio
129-172-4	1	172	100x500x370	9.650 €
105-48-1		105-70-1		
105-42-1		105-50-1		
105-22-1		105-40-1		
105-24-1		115-70-1		
115-22-1		115-48-1		
115-40-1				
125-70-1		125-43-1		
125-25-1		125-40-1		
125-23-1		125-48-1		
101-04-1, 101-045-1, 101-05-1, 101-055-1, 101-06-1, 101-07-1, 101-08-1, 101-09-1, 101-10-1, 101-11-1, 101-12-1, 101-13-1, 101-14-1				1/4"
103-04-1, 103-05-1, 103-06-1, 103-07-1, 103-08-1, 103-09-1, 103-10-1				1/4"
106-04-1, 106-05-1, 106-06-1, 106-07-1, 106-08-1				
112-10-1, 112-11-1, 112-12-1, 112-13-1, 112-14-1, 112-15-1, 112-16-1, 112-17-1, 112-18-1, 112-19-1				3/8"
113-10-1, 113-11-1, 113-12-1, 113-13-1, 113-14-1, 113-15-1				3/8"
126-20-1, 126-24-1				
125-53-1, 125-54-1				
121-10-1, 121-11-1, 121-12-1, 121-13-1, 121-14-1, 121-15-1, 121-16-1, 121-17-1, 121-18-1, 121-19-1, 121-20-1, 121-21-1, 121-22-1, 121-24-1, 121-27-1, 121-30-1, 121-32-1				1/2"
107-T08-1, 107-T09-1, 107-T10-1, 107-T15-1, 107-T20-1, 107-T25-1, 107-T27-1, 107-T30-1				
107-H3-1, 107-H4-1, 107-H5-1, 107-H6-1				
107-PH0-1, 107-PH1-1, 107-PH2-1				
107-PZ0-1, 107-PZ1-1, 107-PZ2-1				
Vasos con punta 1/4": 4.5-5-6-5-7 mm				
Vasos con punta 1/4": T8H-T9H-T10H-T15H-T20H-T25H-T27H-T30H				
Vasos 3/8": E10-E11-E12-E14-E16-E18				
Vaso para bujias 3/8": 16 mm				
Vasos largos 1/2" (6 PT): 16-17-18-19-22 mm				1/2"
Llaves hexagonales: 1.5-2-2.5-3-4-5-6 mm				
20 piezas de 1/4" - Puntas 25 mm: T8-T9-T10-T15-T20-T25-T27-T30-T40-T45 / H3-H4-H5-H6 / PH0-PH1-PH2 / PZ0-PZ1-PZ2				
24 piezas de 8 mm - Puntas 30 mm: T40-T45-T50-T55-T60-T70 / H7-H8-H10-H12-H14 / PH3-PH4 / PZ3-PZ4 / SL8-SL10-SL12				





JUEGO VASOS 1/2"

JUEGO VASOS 1/4" - 3/8" - 1/2" HEXAGONALES, MM



- Juego de vasos de 164 piezas
- Vasos hexagonales, mm
- Acabado cromado brillante
- DIN 3120, DIN 3124, DIN 3122
- Caja fabricada en polietileno de alta densidad y resistente
- Caja con dos cierres extra para mayor seguridad en el transporte

R	📦	📦	📦	📦	€
149-164-4	1	164	490x370x100	12.919	305,16
105-48-1			105-70-1		
105-24-1			105-50-1		
105-22-1			105-40-1		
115-70-1			115-40-1		
115-20-1			115-24-1		
115-44-1			115-46-1		
115-48-1			125-70-1		
125-23-1			125-25-1		
125-46-1			125-40-1		
601-200-1			612-160-1		
475R-1/4-30			48-9-H		
475-5-1					
101-04-1, 101-05-1, 101-055-1, 101-06-1, 101-07-1, 101-08-1, 101-09-1, 101-10-1, 101-11-1, 101-12-1		1/4"			
103-04-1, 103-05-1, 103-06-1, 103-07-1, 103-08-1, 103-09-1, 103-10-1, 103-11-1, 103-12-1		1/4"			
112-08-1, 112-09-1, 112-10-1, 112-11-1, 112-12-1, 112-13-1, 112-14-1, 112-15-1, 112-16-1, 112-17-1, 112-18-1, 112-19-1		3/8"			
113-08-1, 113-09-1, 113-10-1, 113-11-1, 113-12-1, 113-13-1, 113-14-1, 113-15-1, 113-17-1, 113-19-1		3/8"			
121-14-1, 121-17-1, 121-18-1, 121-19-1, 121-20-1, 121-21-1, 121-22-1, 121-24-1, 121-27-1, 121-30-1, 121-32-1		1/2"			
124-12-1, 124-13-1, 124-14-1, 124-15-1, 124-17-1, 124-18-1, 124-19-1, 124-21-1, 124-22-1		1/2"			
167-17-1, 167-19-1, 167-21-1, 167-23-1		1/2"			
18-12-1, 18-13-1, 18-14-1					
25-08-1, 25-09-1, 25-10-1, 25-11-1, 25-12-1, 25-13-1, 25-14-1, 25-17-1, 25-18-1, 25-19-1					
475-T10-1, 475-T15-1, 475-T20-1, 475-T25-1, 475-T27-1, 475-T30-1, 475-T40-1					
475-TR10-1, 475-TR15-1, 475-TR20-1, 475-TR25-1, 475-TR27-1, 475-TR30-1, 475-TR40-1					
Vasos para bujías 3/8": 16-21 mm					
Vasos con punta 3/8": 3-4-5-6 mm					
Vasos con punta 3/8": PH1-PH2					
Vasos con punta 3/8": PZ1-PZ2					
Vasos con punta 3/8": TR10-TR15-TR20-TR25-TR30-TR40					
Vasos 3/8" TORX®: E8, E10, E11, E12, E14, E16, E18, E20					

VASOS 3/4"

VASOS 3/4"

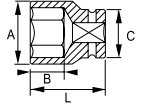

- Vasos en milímetros, diseño hexagonal
- Acero aleado Cromo Vanadio
- Acabado cromado brillante
- Perfil NPP
- DIN 3124, DIN 3120

R	📦	📏	A mm	B mm	C mm	L mm	📦	€
131-19-1	1	19	30	12	36	50	200	10,04
131-21-1	1	21	32	12	36	50	215	10,19
131-22-1	1	22	33	12	36	50	215	10,33
131-23-1	1	23	34	14	36	50	215	10,69
131-24-1	1	24	34	16	36	50	215	11,07
131-25-1	1	25	38	16	36	50	220	11,07
131-26-1	1	26	38	16	36	52	220	11,44
131-27-1	1	27	38	18	36	52	240	11,44
131-28-1	1	28	38	18	36	52	250	12,00
131-29-1	1	29	42	18	38	52	260	12,37
131-30-1	1	30	42	20	38	52	275	12,82
131-32-1	1	32	44	22	38	52	310	13,11
131-33-1	1	33	46	22	38	55	340	13,77
131-34-1	1	34	46	22	38	57	330	14,06
131-35-1	1	35	48	24	42	57	380	14,31
131-36-1	1	36	50	24	42	57	415	15,15
131-38-1	1	38	52	26	44	57	455	16,38
131-40-1	1	40	56	27	44	63	505	17,30
131-41-1	1	41	56	27	44	63	545	18,06
131-42-1	1	42	58	27	44	63	600	19,15
131-46-1	1	46	62	30	44	68	650	21,30
131-50-1	1	50	68	33	44	72	755	24,27
131-55-1	1	55	75	36	48	75	1.000	29,20
131-60-1	1	60	80	39	48	77	1.100	32,47



VASOS 3/4"

VASOS 3/4" BIHEX

12 mm

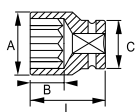

- Vasos en milímetros, diseño bi-hexagonal
- Acero aleado Cromo Vanadio
- Acabado cromado brillante
- Perfil NPP
- DIN 3120, DIN 3124

R			A mm	B mm	C mm	L mm	g	€
131B-19-2	1	19	30	12	36	50	200	10,04
131B-21-2	1	21	32	12	36	50	215	10,19
131B-22-2	1	22	33	12	36	50	215	10,33
131B-23-2	1	23	34	14	36	50	215	10,69
131B-24-2	1	24	34	16	36	50	215	11,07
131B-26-2	1	26	38	16	36	52	220	11,44
131B-27-2	1	27	38	18	36	52	240	11,44
131B-29-2	1	29	42	18	38	52	260	12,37
131B-30-2	1	30	42	20	38	52	275	12,82
131B-32-2	1	32	44	22	38	52	310	13,11
131B-35-2	1	35	48	24	42	57	380	14,31
131B-36-2	1	36	50	24	42	57	415	15,15
131B-38-2	1	38	52	26	44	57	455	16,38
131B-41-2	1	41	56	27	44	63	545	18,06
131B-46-2	1	46	56	27	44	63	545	21,30
131B-50-2	1	50	67	29	46	72	715	24,27

12 in

R			A mm	B mm	C mm	L mm	g	€
132A-28-1	1	7/8"	33	12	36	50	215	10,60
132A-30-1	1	15/16"	35	16	36	50	215	11,15
132A-32-1	1	1"	38	16	36	52	200	11,25
132A-34-1	1	1.1/16"	38	18	36	54	240	11,62
132A-36-1	1	1.1/8"	42	18	38	55	280	12,18
132A-40-1	1	1.1/4"	44	22	38	55	310	13,48
132A-42-1	1	1.5/16"	46	22	38	57	340	14,60
132A-44-1	1	1.3/8"	48	24	42	57	380	14,88
132A-46-1	1	1.7/16"	50	24	42	57	415	15,44
132A-48-1	1	1.1/2"	52	26	44	57	455	16,74
132A-52-1	1	1.5/8"	56	27	44	63	545	18,33
132A-54-1	1	1.11/16"	58	27	44	63	600	19,45
132A-60-1	1	1.7/8"	65	30	44	68	700	24,93
132A-64-1	1	2"	68	33	44	72	755	24,93

ACCESORIOS 3/4"

CABEZA DE CARRACA

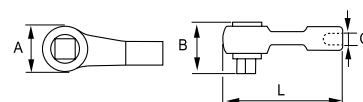

- 24 dientes
- Acabado cromado brillante
- Botón de rápida liberación
- Mango bicomponente
- DIN 3120, DIN 3122

R		A mm	B mm	C mm	L mm	g	€
135-70-1	1	65	61.5	20	155	1.360	67,10

ALARGADERAS

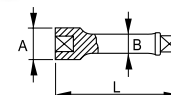

- Sistema de retención por bola

R		A mm	B mm	L mm	g	€
135-21-1	1	36	23	125	515	18,21
135-22-1	1	36	23	200	725	21,39
135-24-1	1	36	23	400	1.350	28,55

MANERAL

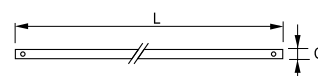

- Mango de carraca

R		C mm	L mm	g	€
135-85-1	1	20	450	1.100	14,36

MANGO CORREDIZO EN T

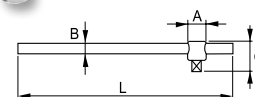

- Sistema de retención por bola

R		A mm	B mm	C mm	L mm	g	€
135-42-1	1	36	20	60	450	1.335	32,84



ACCESORIOS 3/4"

CABEZA MANGO CORREDIZO

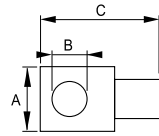

- Sistema de retención por bola

R	Icono	A mm	B mm	C mm	g	€
135-43-1	1	35	20.5	60	235	12,82

ARTICULACIÓN UNIVERSAL

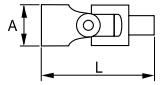

- Sistema de retención por bola

R	Icono	A mm	L mm	g	€
135-40-1	1	40	108	540	47,90

REDUCTOR

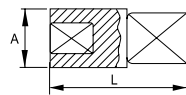

- Adaptador reductor 3/4" a 1/2"
- Sistema de retención por bola

R	Icono	A mm	L mm	g	€
135-46-1	1	36	54	260	15,36

MANGO ARTICULADO

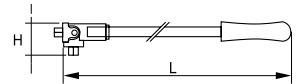

- Sistema de retención por bola

R	Icono	H mm	L mm	g	€
135-52-1	1	40	450	1.700	40,27

JUEGO VASOS 3/4"

JUEGO VASOS 3/4", HEXAGONALES, MM, 17 piezas



- Juego de vasos 17 piezas
- Vasos hexagonales, mm
- Acero aleado Cromo Vanadio
- Acabado cromado brillante
- DIN 3120, DIN 3124, DIN 3122
- Caja fabricada en polietileno de alta densidad y resistente
- Caja con cierres metálicos
- Referencia caja de repuesto: SP-106S-BOX17
- Referencia dos cierres de recambio: SP104S

R	Icono	X	Icono	g	€
139-17-4	1	17	475x295x100	12.500	201,77

135-70-1		135-24-1	
----------	--	----------	--

135-22-1		135-43-1	
----------	--	----------	--

135-85-1	
----------	--

131-22-1, 131-24-1, 131-27-1, 131-30-1, 131-32-1, 131-33-1, 131-34-1, 131-36-1, 131-38-1, 131-41-1, 131-46-1, 131-50-1		
--	--	--

JUEGO VASOS 3/4", HEXAGONALES, MM, 21 piezas



- Juego de vasos de 21 piezas
- Vasos hexagonales, mm
- Acero aleado Cromo Vanadio
- Acabado cromado brillante
- DIN 3120, DIN 3124, DIN 3122
- Caja fabricada en polietileno de alta densidad y resistente
- Caja con cierres metálicos
- Referencia caja de recambio: SP-106S-BOX21

R	Icono	X	Icono	g	€
139-21-4	1	21	475x295x100	11.900	235,63

135-70-1		135-24-1	
----------	--	----------	--

135-22-1		135-43-1	
----------	--	----------	--

135-85-1	
----------	--

131-19-1, 131-21-1, 131-22-1, 131-23-1, 131-24-1, 131-26-1, 131-27-1, 131-29-1, 131-30-1, 131-32-1, 131-35-1, 131-36-1, 131-38-1, 131-41-1, 131-46-1, 131-50-1		
--	--	--



JUEGO VASOS 3/4", BIHEXAGONALES, MM, 21 piezas

3/4" mm



- Juego de vasos de 21 piezas
- Vasos bihexagonales, mm
- Acero aleado Cromo Vanadio
- Acabado cromado brillante
- DIN 3120, DIN 3124, DIN 3122
- Caja fabricada en polietileno de alta densidad y resistente
- Caja con cierres metálicos
- Referencia caja de recambio: SP-106S-BOX21

Artículo	Paquete	Cantidad	Dimensiones	Peso	Precio
139-21B-4	1	21	475x295x100	11.900	235,63
135-70-1			135-24-1		
135-22-1			135-43-1		
135-85-1					

131B-19-2, 131B-21-2, 131B-22-2, 131B-23-2, 131B-24-2, 131B-26-2, 131B-27-2, 131B-29-2, 131B-30-2, 131B-32-2, 131B-35-2, 131B-36-2, 131B-38-2, 131B-41-2, 131B-46-2, 131B-50-2

VASOS IMPACTO 3/8"

VASOS DE IMPACTO 3/8" HEX

6 mm

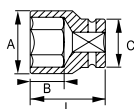

- Vasos en milímetros, diseño hexagonal
- UNE 16507, ISO 2725, DIN 3129

Artículo	Paquete	Diámetro	A mm	B mm	C mm	L mm	Peso g	Precio €
160-07-1	1	7	12.6	13	19	32	39	2,45
160-08-1	1	8	14	13	19	32	39	2,45
160-10-1	1	10	15.8	13	19	32	40	2,45
160-11-1	1	11	16.9	13	19	32	41	2,45
160-12-1	1	12	18.2	13	19	32	41	2,45
160-13-1	1	13	19.5	13	22	32	54	2,69
160-14-1	1	14	20.5	13	22	32	54	2,69
160-15-1	1	15	22	16	22	32	54	2,69
160-16-1	1	16	24	16	22	32	57	3,16
160-17-1	1	17	25	17	22	34	67	3,16
160-18-1	1	18	26	17	22	34	67	3,47
160-19-1	1	19	28	17	22	34	71	3,47
160-20-1	1	20	28	17	22	34	79	3,47
160-21-1	1	21	30	17	22	34	80	3,80
160-24-1	1	24	34	17	22	34	102	4,53

VASOS DE IMPACTO 3/8" HEX, SERIE LARGA

6 mm

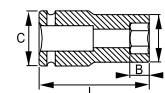

Artículo	Paquete	Diámetro	A mm	B mm	C mm	L mm	Peso g	Precio €
161-10-1	1	10	15.9	10	19	63	77	7,59
161-13-1	1	13	19.7	10	19	63	96	8,05
161-17-1	1	17	24.5	11	22	63	184	9,49



ACCESORIOS 3/8"

ALARGADERAS



- DIN 16503, ISO 1174

R		A mm	B mm	L mm	g	€
162-00-1	1	19	12.5	75	99	4,79
162-02-1	1	19	12.5	150	159	6,50

JUNTA CARDAN



- DIN 16503, ISO 1174

R		A mm	L mm	g	€
162-50-1	1	22	50	124	12,29

REDUCTOR



- Reductor de 3/8" a 1/4"
- DIN 16503, ISO 1174
- Dadas las condiciones especiales de este producto, no está garantizado contra la rotura del cuadrado macho

R		A mm	L mm	g	€
162-65-1	1	19	28	57	6,50

AUMENTADOR



- Aumentador de 3/8" a 1/2"
- DIN 16503, ISO 1174

R		A mm	L mm	g	€
162-60-1	1	22	36	96	8,39

ANILLAS DE SEGURIDAD



- Anillas de seguridad 3/8"

R				g	€
162931	1	3/8"	7-12	2	4,79
162941	1	3/8"	13-24	2	4,79



VASOS IMPACTO 1/2"

VASOS DE IMPACTO 1/2" HEX

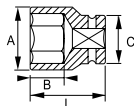

- Vasos en milímetros, diseño hexagonal
- UNE 16507, ISO 2725, DIN 3129

Artículo	Paquete	Ø	A mm	B mm	C mm	L mm	Peso (g)	€
167-08-1	1	8	15	15	25	38	84	4,05
167-10-1	1	10	17.5	15	25	38	89	4,02
167-12-1	1	12	19	15	25	38	94	4,38
167-13-1	1	13	20	15	25	38	94	4,57
167-14-1	1	14	22	15	25	38	94	4,81
167-15-1	1	15	23	15	25	38	134	4,90
167-16-1	1	16	24	15	25	38	134	5,12
167-17-1	1	17	26	15	30	38	134	5,26
167-18-1	1	18	27	15	30	38	134	5,26
167-19-1	1	19	28	17.5	30	38	134	5,52
167-20-1	1	20	29	17.5	30	38	137	5,61
167-21-1	1	21	30	17.5	30	38	149	5,82
167-22-1	1	22	32	17.5	30	38	149	6,00
167-23-1	1	23	34	18	30	40	149	6,29
167-24-1	1	24	34	18	30	40	179	6,68
167-26-1	1	26	36	22	30	42	189	6,95
167-27-1	1	27	38	22	30	42	204	7,23
167-30-1	1	30	42	22	30	44	234	8,02
167-32-1	1	32	44	22	40	44	282	8,23
167-34-1	1	34	46	22	40	48	406	9,83
167-36-1	1	36	48	22	40	48	467	10,12
167-38-1	1	38	50	23	40	48	480	12,91
167-41-1	1	41	50	24	42	48	495	13,48

JUEGO VASOS DE IMPACTO EN RAIL



Artículo	Paquete	Paquete	Paquete	Peso (g)	€
167-91-2	1	5	17 - 19 - 22 - 24 - 27 mm	835	30,05
167-90-2	1	9	8 - 10 - 12 - 14 - 17 - 19 - 22 - 24 - 27 mm	1.180	46,81

JUEGO VASOS DE IMPACTO 1/2", 10 piezas



- Juego con 10 vasos de impacto
- Vasos hexagonales
- Acabado fosfatado
- ISO 2725, DIN 3129
- Caja fabricada en polietileno de alta densidad y resistente

Artículo	Paquete	Paquete	Paquete	Peso (g)	€
167-10-4	1	10	200x160x52	1.425	35,35

167-10-1, 167-13-1, 167-14-1, 167-16-1, 167-17-1, 167-18-1, 167-19-1, 167-21-1, 167-22-1, 167-24-1





VASOS IMPACTO 1/2"

VASOS DE IMPACTO 1/2" HEX, SERIE LARGA



R	Icon	Ø	A mm	B mm	C mm	L mm	g	€
168-10-1	1	10	17.5	24	25	78	118	11,13
168-11-1	1	11	18	24	25	78	121	11,23
168-13-1	1	13	20	24	25	78	163	11,44
168-14-1	1	14	22	37	25	78	190	12,13
168-16-1	1	16	24	37	25	78	239	12,13
168-17-1	1	17	26	37	30	78	239	12,13
168-18-1	1	18	27	37	30	78	239	12,13
168-19-1	1	19	28	39	30	78	246	12,13
168-21-1	1	21	30	39	30	78	267	12,42
168-22-1	1	22	32	39	30	78	328	17,45
168-23-1	1	23	34	39	30	78	348	17,50
168-24-1	1	24	34	39	30	78	351	17,54
168-27-1	1	27	38	39	30	78	373	17,86
168-30-1	1	30	42	39	30	78	409	19,34
168-32-1	1	32	43	40	32	78	415	21,51

JUEGO VASOS DE IMPACTO LARGOS EN RAIL



R	Icon	Icon	Icon	g	€
168-90-2	1	7	10 - 13 - 17 - 19 - 22 - 24 - 27 mm	1.735	97,28

ANILLAS DE SEGURIDAD



• Anillas de seguridad 1/2"

R	Icon	Icon	Icon	Icon	g	€
169921	1	1/2"	10-14	5-10	2	4,81
169931	1	1/2"	15-36	12-19	2	4,81

ACCESORIOS 1/2"

ALARGADERA



• DIN 16503, ISO 1174

R	Icon	A mm	B mm	L mm	g	€
169-03-1	1	25	16.5	75	139	8,96
169-01-1	1	25	16.5	125	274	9,42
169-02-1	1	25	16.5	150	484	11,64

AUMENTADOR

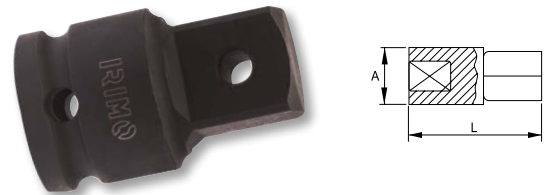

• Aumentador de 1/2" a 3/4"
• DIN 16503, ISO 1174

R	Icon	A mm	L mm	g	€
169-60-1	1	30	48	114	12,82

REDUCTOR



• Reductor de 1/2" a 3/8"
• DIN 16503, ISO 1174
• Dadas las condiciones especiales de este producto, no está garantizado contra la rotura del cuadrado macho

R	Icon	A mm	L mm	g	€
169-65-1	1	25	38	129	10,64

JUNTA CARDAN



• DIN 16503, ISO 1174

R	Icon	A mm	L mm	g	€
169-25-1	1	30	63	189	20,05



VASOS IMPACTO 3/4"

VASOS DE IMPACTO 3/4" HEX

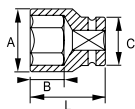

- Vasos en milímetros, diseño hexagonal
- UNE 16507, ISO 2725, DIN 3129

Q	Icon	A mm	B mm	C mm	L mm	g	€	
173-17-2	1	17	30	21	44	51	339	11,05
173-18-2	1	18	32	21	44	51	339	11,35
173-19-2	1	19	33	21	44	51	349	11,66
173-21-2	1	21	35	21	44	51	359	11,83
173-22-2	1	22	36	21	44	51	359	12,00
173-23-2	1	23	37	21	44	51	369	12,41
173-24-2	1	24	38	21	44	51	379	12,85
173-27-2	1	27	41	21	44	51	399	13,28
173-28-2	1	28	42	23	44	51	409	13,93
173-29-2	1	29	45	23	44	51	409	14,37
173-30-2	1	30	46	23	44	51	439	14,89
173-32-2	1	32	48	27	44	57	469	15,22
173-33-2	1	33	50	27	44	57	489	16,00
173-34-2	1	34	51	27	44	57	509	16,30
173-36-2	1	36	53	27	44	57	519	17,60
173-38-2	1	38	56	27	44	57	559	19,01
173-41-2	1	41	59	28	44	58	659	20,97
173-46-2	1	46	66	30	44	62	709	24,73
173-50-2	1	50	71	32	54	65	839	28,19
173-55-2	1	55	77	37	54	70	1109	33,90
173-60-2	1	60	84	37	54	70	1200	37,70

JUEGO DE VASOS IMPACTO 3/4", 8 piezas



- Juego en caja metálica

Q	Icon	Icon	Icon	g	€
173-01-5	1	8	24 - 27 - 29 - 30 - 32 - 34 - 36 - 38 mm	4.000	121,92

VASOS DE IMPACTO 3/4" HEX, SERIE LARGA

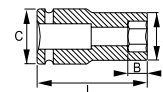

Q	Icon	A mm	B mm	C mm	L mm	g	€	
174-17-2	1	17	30	23	44	90	560	19,06
174-19-2	1	19	33	23	44	90	600	20,10
174-21-2	1	21	35	23	44	90	680	20,40
174-22-2	1	22	36	23	44	90	700	20,69
174-24-2	1	24	38	23	44	90	750	22,18
174-27-2	1	27	41	23	44	90	800	22,90
174-30-2	1	30	46	27	44	90	898	27,11
174-32-2	1	32	48	27	44	90	957	27,69
174-33-2	1	33	50	27	44	90	1010	29,09
174-34-2	1	34	51	27	44	90	1030	31,36
174-36-2	1	36	55	27	44	90	1084	33,83
174-41-2	1	41	59	28	44	90	1270	40,28

ACCESORIOS 3/4"

JUNTA CARDAN

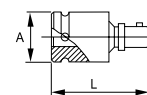

- DIN 16503, ISO 1174

Q	Icon	A mm	L mm	g	€
175-25-2	1	42	92	580	55,60

ANILLAS DE SEGURIDAD

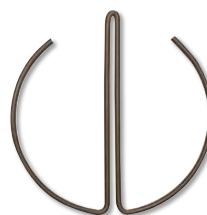

- Anillas de seguridad 3/4"

Q	Icon	Icon	Icon	Icon	g	€
175911	1	3/4"	17-46	12-24	2	5,46
179931	1	3/4"	50-60		2	6,17



ACCESORIOS 3/4"

ALARGADERAS

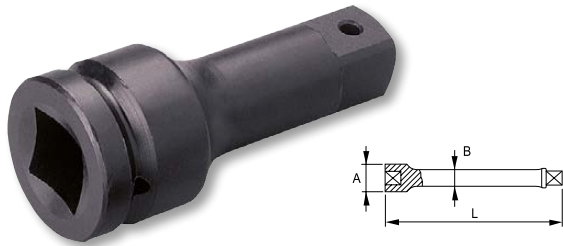

- DIN 16503, ISO 1174

R		A mm	B mm	L mm	g	€
175-01-2	1	175	44	21	850	21,16
175-10-2	1	250	44	21	1.190	24,84
175-02-2	1	325	44	21	1.460	33,16

AUMENTADOR

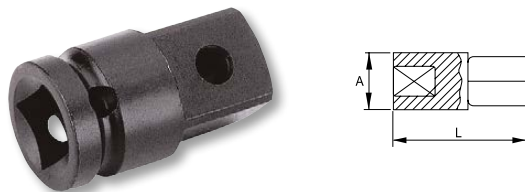

- Aumentador de 3/4" a 1"
- DIN 16503, ISO 1174

R		A mm	L mm	g	€
175-60-2	1	44	63	410	30,07

REDUCTOR



- Reductor de 3/4" a 1/2"
- DIN 16503, ISO 1174
- Dadas las condiciones especiales de este producto no está garantizado contra la rotura del cuadrado macho

R		A mm	L mm	g	€
175-65-2	1	44	57	350	17,82

VASOS IMPACTO 1"

VASOS DE IMPACTO 1" HEX



- Vasos en milímetros, diseño hexagonal
- UNE 16507, ISO 2725, DIN 3129

R		A mm	B mm	C mm	L mm	g	€	
177-22-2	1	22	39	22	54	58	645	18,62
177-24-2	1	24	41	22	54	58	650	19,95
177-27-2	1	27	46	22	54	58	670	20,61
177-30-2	1	30	49	24	54	62	680	22,31
177-32-2	1	32	52	24	54	62	695	22,78
177-33-2	1	33	54	24	54	62	695	23,94
177-34-2	1	34	54	24	54	62	720	21,08
177-36-2	1	36	56	29	54	65	800	25,25
177-38-2	1	38	58	29	54	65	845	27,28
177-41-2	1	41	61	34	54	70	920	31,60
177-42-2	1	42	64	34	54	70	950	31,91
177-46-2	1	46	68	36	54	75	1150	33,75
177-50-2	1	50	73	36	54	75	1375	42,96
177-55-2	1	55	79	44	54	83	1540	49,05
177-60-2	1	60	86	47	54	87	1700	58,38
177-65-2	1	65	92	47	54	90	1940	65,66
177-70-2	1	70	97	47	54	93	2450	71,79
177-75-2	1	75	104	47	86	95	2900	79,16
177-80-2	1	80	110	39	86	100	3300	93,28

JUEGO DE VASOS IMPACTO 1", 7 piezas



- Juego en caja metálica

R		X		g	€
177-10-5	1	7	24 - 27 - 30 - 32 - 33 - 36 - 38 mm	5.500	156,92



VASOS DE IMPACTO 1" HEX, SERIE LARGA

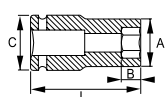

Q			A mm	B mm	C mm	L mm	g	€
178-22-2	1	22	39	23	54	90	975	24,19
178-24-2	1	24	42	23	54	90	1016	25,93
178-27-2	1	27	46	23	54	90	1134	26,78
178-30-2	1	30	49	24	54	90	1256	27,47
178-32-2	1	32	52	24	54	90	1297	28,05
178-33-2	1	33	54	24	54	92	1311	30,74
178-34-2	1	34	54	24	54	92	1350	27,06
178-36-2	1	36	56	29	54	92	1474	30,40
178-38-2	1	38	58	29	54	92	1479	32,84
178-41-2	1	41	61	34	54	92	1533	40,87
178-46-2	1	46	68	36	54	95	1710	32,66
178-50-2	1	50	73	36	54	95	1896	41,65
178-55-2	1	55	79	44	54	100	2155	52,58
178-60-2	1	60	86	47	54	100	2372	60,80

ACCESORIOS 1"

ALARGADERAS

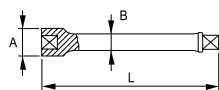

• DIN 16503, ISO 1174

Q		A mm	B mm	L mm	g	€
179-00-2	1	125	54	34	1.085	78,98
179-01-2	1	175	54	34	1.390	85,06
179-02-2	1	325	54	34	2.395	99,16

ANILLAS DE SEGURIDAD

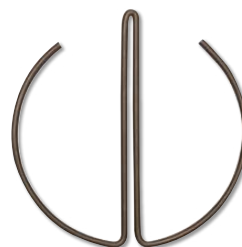

• Anillas de seguridad 1"

Q			19-70	17-27	g	€
179931	1	1"	19-70	17-27	9	6,17
179941	1	1"	75-80		13	8,13

REDUCTOR

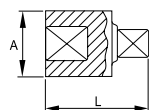

• Reductor de 1" a 3/4"
 • DIN 16503, ISO 1174
 • Dadas las condiciones especiales de este producto, no está garantizado contra la rotura del cuadrado macho

Q		A mm	L mm	g	€
179-65-2	1	54	70	350	18,60

JUNTA CARDAN

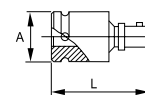

• DIN 16503, ISO 1174

Q		A mm	L mm	g	€
179-52-2	1	54	120	650	187,91



TORNILLOS HEXAGONALES HEMBRA

mm	mm.							U.S.A.			G.B.	
	DIN 912 DIN 6912	DIN 7984	DIN 7991	DIN 913-916	inch	mm	USAS B 18-3-1969			BS 2470-1954		
1.5	1.6-2			2.5	1/16"	1.59	Nº 1			6 BA	5 BA-4 BA	
2	2.5			3	5/64"	1.98	Nº 2-Nº 3	Nº 3-Nº 4		5 BA-4 BA	3 BA	
2.5	3	3		3.5-4	3/32"	2.38	Nº 4-Nº 5	Nº 5-Nº 6 Nº 8			3/16-2 BA-1 BA	
3	4	5		5	7/64"	2.78	Nº 6	Nº 10			0 BA-1/4	
4	5	6		6	1/8"	3.17						
5	6	8		8	9/64"	3.57	Nº 8		1/4"			
6	8			10	5/32"	3.97			5/16"	3/16-2 BA-1 BA		
7	10	10		12	3/16"	4.75	Nº 10	1/4"	3/8"	1/4-0 BA	5/16	
8	12	12		16	7/32"	5.55	1/4"	5/16"	3/8"	5/16"	3/8-BSP 1/8	
9					1/4"	6.35	5/16"	7/16"	1/2"		1/2-BSP 1/4	
10	12			20	5/16"	7.94	3/8"	1/2"	5/8"	3/8-7/16"	5/8-BSP 3/8	
12	14	16-18	14-16	24	3/8"	9.52	7/16-1/2"	5/8"	3/4"	1/2"	3/4-BSP 1/2	
14	16-18	20-22	18-20		1/2"	12.70			7/8"	5/8"	7/8-BSP 5/8	
17	20-22				9/16"	14.29			1"	3/4-7/8"	1-BSP 3/4	
19	24-27				5/8"	15.88			1 1/4-1 3/8"	1"		
22	30				3/4"	19.05			1 1/2"			

DIÁMETROS DE ROSCAS Y DIMENSIONES ENTRE CARAS

mm	mm.							UNIFIED			U.S.A.			G.B.			
	ISO 972 1982	UNE 17052 1978	DIN 931 1970	NFE 27111 1930	DS 2074-5 1988	A.F.	mm	BS 1769	BS 1768	BS 1768	ASAB 18-2.2 ASAB 18-2.1	ASAB 18-2.1	ASAB 18-2.2	inch	mm	BS 916-1083	BA BS 57W BS 192
3.2	1.6	1.6	1.6			3/32"	2.38							0.117	2.97		10 BA
3.5			1.7			1/8"	3.17							0.131	3.32		9 BA
4	2	2	2	2.5		5/32"	3.97							0.172	4.37		7 BA
4.5			2.3											0.193	4.90		6 BA
5	2.5	2.5	2.6	3		3/16"	4.76							0.220	5.59		5 BA
5.5	3	3	3	3.5		7/32"	5.56							0.248	6.30		4 BA
6	3	3	3.5	4-4.5		1/4"	6.35							0.282	7.16		3 BA
7	4	4	4	5		9/32"	7.14							0.324	8.23		2 BA
8	5	5	5	5.5		5/16"	7.94							0.340	8.64	3/16"	1/8 W
9						11/32"	8.73							0.365	9.27		1 BA
10	6	6	6	6	1/4"	3/8"	9.52							0.413	10.49	1/4"	0 BA
11	7	7	7	7		7/16"	11.11		1/4"	1/4"				0.445	11.30	1/4"	3/16 W
12																	
13	8	8	8	8		1/2"	12.70	1/4"	5/16"	5/16"	1/4"	5/16"	5/16"	0.525	13.34	5/16"	1/4 W
14						9/16"	14.29	5/16"	3/8"	3/8"	5/16"	5/16"	5/16"	0.600	15.24	3/8"	5/16 W
15						19/32"	15.08										
16	10	10	10	9		5/8"	15.88										
17	12	12	12	10	3/8"	11/16"	17.46		7/16"	7/16"				0.710	18.03	7/16"	3/8 W
18																	
19	14	12	12	11	7/16"	3/4"	19.05	3/8"	1/2"	1/2"	7/16"	7/16"	7/16"	0.820	20.83	7/16"	3/8 W
21	14	14	14	12	1/2"	7/8"	22.22	7/16"	9/16"	9/16"	1/2"	1/2"	9/16"	0.920	23.37	1/2"	7/16 W
22																	
23	16	16	16	14		15/16"	23.81							0.920	23.37	9/16"	1/2 W
24						1"	25.40		5/8"	5/8"	9/16"	9/16"	9/16"	1.010	25.65	5/8"	9/16 W
26																	
27	18	18	18	16	5/8"	1 1/16"	26.99	5/8"			5/8"	5/8"	5/8"	1.100	27.94	11/16"	5/8 W
28						1 1/8"	28.58		3/4"	3/4"							
29				18													
30	20	20	20	20	3/4"	1 3/16"	30.16							1.200	30.48	3/4"	11/16 W
32						1 1/4"	31.75	3/4"	7/8"	7/8"	3/4"	3/4"	3/4"	1.300	33.02	7/8"	3/4 W
34	22	22	22	20		1 5/16"	33.34							1.390	35.31	15/16"	13/16 W
35				22	7/8"	1 3/8"	34.92		7/8"	7/8"	7/8"	7/8"	7/8"	1.480	37.59	1"	7/8 W
36	24	24	24	24		1 7/8"	36.51		1"	1"	1"	1"	1"	1.480	37.59	1"	7/8 W
38						1 1/2"	38.10										
41	27	27	27	27	1"	1 5/8"	41.28	1"	1 1/8"	1 1/8"	1"	1"	1"	1.670	42.42	1 1/8"	1 W
42						1 11/16"	42.86										
46	30	30	30	30	1 1/8"	1 13/16"	46.04	1 1/8"	1 1/4"	1 1/4"	1 1/8"	1 1/8"	1 1/8"	1.860	47.24	1 1/4"	1 1/8 W
50	33	33	33	33	1 1/4"	1 7/8"	47.62	1 1/4"			1 1/4"	1 1/4"	1 1/4"				
54						2"	50.80										
55	36	36	36	36	1 1/4"	2 1/16"	52.39		1 3/8"	1 3/8"	1 3/8"	1 3/8"	1 3/8"	2.050	52.07	1 3/8"	1 1/4 W
58						2 3/16"	55.56	1 3/8"	1 1/2"	1 1/2"	1 3/8"	1 3/8"	1 3/8"	2.220	56.39	1 1/2"	1 3/8 W
60	39	39	39	39	1 1/2"	2 1/4"	57.17										
63						2 3/8"	60.32	1 1/2"			1 1/2"	1 1/2"	1 1/2"	2.410	61.21	1 5/8"	1/2 W
65	42	42	42	42	1 5/8"	2 7/16"	61.91				1 5/8"	1 5/8"	1 5/8"	2.580	65.53	1 3/4"	1 5/8 W
67						2 9/16"	65.09										
70	45	45	45	45	1 3/4"	2 5/8"	66.68	1 3/4"	1 3/4"	1 3/4"	1 3/4"	1 3/4"	1 3/4"	2.760	70.10	2"	1 3/4 W
71						2 3/4"	69.85				1 3/4"	1 3/4"	1 3/4"				
75	48	48	48	48	1 7/8"	2 13/16"	71.44										
77						2 15/16"	74.61				1 7/8"	1 7/8"	1 7/8"				
80	52	52	52	52	2"	3"	76.20	2"	2"	2"	2"	2"	2"	3.150	76.70	2 1/4"	1 7/8 W
82						3 1/8"	79.38								80.01		2 W
85	56	56	56	56	2 1/4"	3 3/8"	85.72										
88						3 1/2"	88.90				2 1/4"	2 1/4"	2 1/4"				
90	60	60	60	60										3.550	90.17	2 1/2"	
94																	
95	64	64	64	64	2 1/2"	3 3/4"	95.25										
100	68	68	68	68		3 7/8"	98.42				2 1/2"	2 1/2"	2 1/2"	3.890	98.81	2 3/4"	3"
105	72	72	72	72	2 3/4"	4 1/8"	104.78							4.180	106.17		
110	76	76	76	76	3"	4 1/4"	107.95				2 3/4"	2 3/4"	2 3/4"				
115	80	80	80	80		4 1/2"	114.30							4.530	115.06	3 1/4"	
116																	
120	85	85	85	85	3 1/4"	4 5/8"	117.48				3"	3"	3"	4.850	123.19	3 1/2"	



05. TORNILLOS DE BANCO



TORNILLOS DE BANCO

GUÍA REDONDA

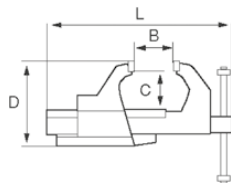
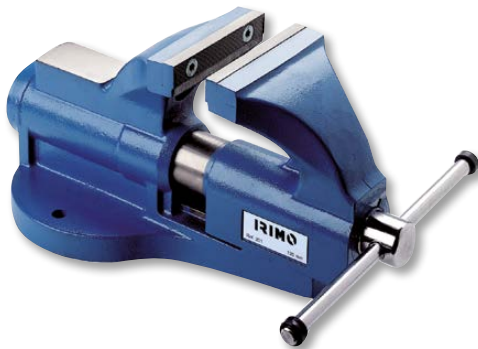

- Tornillo de banco guía redonda
- Fabricado en acero de alta calidad
- Altamente resistente
- Mordazas intercambiables
- Zona de golpeo de mayor superficie
- Husillo con rosca y palanca de giro con suave desplazamiento
- Puede ser utilizado con base giratoria

R			B mm	C mm	D mm	L mm	g	€
201231	1	80	90	42	130	260	5.850	217,93
201241	1	100	110	56	166	325	11.350	290,54
201251	1	125	130	72	196	375	18.200	400,18
201261	1	150	170	80	230	430	29.700	568,79

GUÍA CUADRADA, AJUSTE REGULABLE



- Tornillo de banco guía cuadrada
- Fabricado en acero de alta calidad
- Mordazas para tubos
- Mordazas intercambiables
- Zona de golpeo de mayor superficie
- Husillo laminado con rosca y palanca con giro y desplazamiento suave
- Compatible con base giratoria
- Ajuste de guía regulable
- Apoyo de la guía en 4 superficies mecanizadas

R			B mm	C mm	D mm	L mm	g	€
216041	1	100	145	50	122	325	6.497	265,74
216051	1	125	170	63	152	402	13.733	357,09
216061	1	150	230	80	182	492	20.388	451,21
216071	1	175	250	94	211	551	30.688	586,83

GUÍA CUADRADA

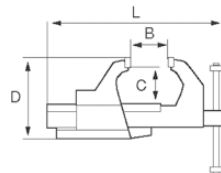

- Tornillo de banco guía cuadrada
- Fabricado en acero de alta calidad
- Alojamiento para mordazas para tubos
- Mordazas intercambiables
- Zona de golpeo de mayor superficie
- Husillo con rosca y palanca con giro suave
- Compatible con base giratoria

R			B mm	C mm	D mm	L mm	g	€
207041	1	100	145	50	122	325	6.200	226,14
207051	1	125	170	63	152	402	13.200	316,58
207061	1	150	230	80	182	492	19.800	407,04
207071	1	175	250	94	211	551	30.100	542,71



GUÍA CUADRADA

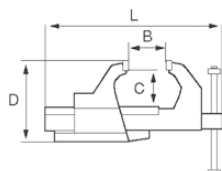

- Tornillo banco guía cuadrada
- Fundición dúctil para mayor resistencia a impactos, con características similares al acero
- Fijado con la base giratoria
- Yunque cuadrado largo
- Pin sujeción al husillo para evitar la caída de la mordaza
- Mordazas y husillos disponibles
- Certificación GS

R	Icono	Icono	B mm	C mm	D mm	L mm	g	€
207-100	1	100	100	61	164	330	11.450	146,53
207-125	1	125	125	72	193	408	20.000	219,78
207-150	1	150	150	84	223	466	29.700	286,95

REPUESTOS PARA TORNILLOS DE BANCO

MORDAZAS DE REPUESTO

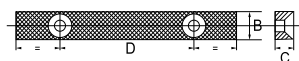

- Pareja de mordazas y tornillos para tornillo guía redonda 201

R	Icono	Icono	B mm	C mm	D mm	g	€
202401	1	80	15	10	55	170	22,40
202411	1	100	20	12	64	350	22,94
202421	1	125	20	12	77	450	33,93
202431	1	150	25	14	90	750	33,93

MORDAZAS DE REPUESTO

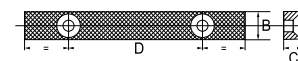

- Pareja de mordazas y tornillos para tornillo guía cuadrada 207041 / 207071 y 216

R	Icono	Icono	B mm	C mm	D mm	g	€
202441	1	100	15	10	64	350	22,94
202421	1	125	20	12	77	450	33,93
202451	1	150	20	12	90	750	41,52
202461	1	175	25	14	105	1.020	49,47

MORDAZAS DE REPUESTO

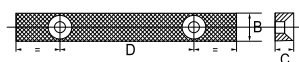

- Pareja de mordazas con tornillos para tornillo guía cuadrada 207-100 / 207-150

R	Icono	Icono	B mm	C mm	D mm	g	€
202-100	1	100	20	10	60	270	18,86
202-125	1	125	21	12	75	460	23,30
202-150	1	150	21	12	90	550	26,71

MORDAZAS PARA TUBO



- Pareja de mordazas de tubo y tornillos para tornillo guía cuadrada 207041 / 207071 y 216

R	Icono	Icono	Icono	Icono	Icono	g	€
206721	1	100	13.5 - 26.9			245	30,61
206741	1	125	21.3 - 76.1			436	38,02
206761	1	150 / 175	26.9 - 89.0			478	38,02





REPUESTOS PARA TORNILLOS DE BANCO

HUSILLO Y TUERCA



- Husillo y tornillo para guía redonda 201

R					€
202811	1	80	251	875	43,93
202821	1	100	317	1.400	71,25
202831	1	125	364	2.200	52,26
202841	1	150	428	3.400	121,18

HUSILLO Y TUERCA



- Husillo y tuerca para tornillo guía cuadrada 207041 / 207071 y 216

R					€
206821	1	100	287	600	40,25
206831	1	125	352	1.400	57,28
206841	1	150	432	2.200	102,40
206851	1	175	471	3.200	131,73

HUSILLO Y TUERCA



- Husillo y tuerca para tornillo guía cuadrada 207-100 / 207-150

R					€
206-100	1	100	165	560	20,83
206-125	1	125	188	920	25,22
206-150	1	150	216	1.060	28,13

ACCESORIOS PARA TORNILLOS DE BANCO

SET DE MORDAZAS DE PROTECCIÓN PARA TORNILLOS DE BANCO



- Mordazas prismáticas de aluminio endurecido
- Ofrece una eficiente sujeción y protección de la pieza al mismo tiempo
- Diseñado para sujeción horizontal de objetos planos y redondos
- Diseñado para sujeción vertical de objetos redondos
- Ángulo de 90° en la parte superior para sujetar
- Ranura en V horizontal con un ángulo de 120° para la sujeción de tuberías y otras piezas redondas
- 3 ranuras en V verticales con ángulos de 100°, 120° y 130° para sujeción de tuberías y otras piezas redondas
- Tira magnética de neodimio extremadamente potente

R				€
202561	1	100	180	33,32
202571	1	125	200	34,60
202581	1	150	220	36,03

SET DE MORDAZAS DE PROTECCIÓN PARA TORNILLOS DE BANCO



- Mordazas neutras de aluminio endurecido
- Para la sujeción de acabados rugosos o medios, piezas mecanizadas
- Policarbonato (PC) extruido resistente a los impactos
- El aluminio endurecido ofrece una resistencia superior a la corrosión junto con un excelente acabado de la superficie
- Tira magnética de neodimio extremadamente potente

R				€
202511	1	100	180	33,07
202521	1	125	200	34,47
202541	1	150	220	35,72



SET DE MORDAZAS DE PROTECCIÓN PARA TORNILLOS DE BANCO

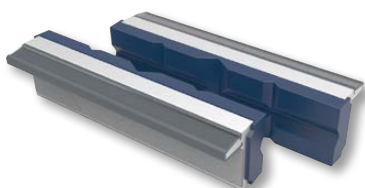

- Mordazas de poliuretano con ranuras
- Para sujeción de piezas redondas con detalles muy delicados
- Las mordazas están fabricadas con un material especial de poliuretano flexible
- Dureza Shore A82
- El poliuretano es conocido por sus habilidades únicas para "morder" la pieza de trabajo sin dañarla o rayarla
- El poliuretano es tan flexible que vuelve a su forma original después de la deformación
- Tira magnética de neodimio extremadamente potente

€			g	€
202661	1	100	150	39,17
202671	1	125	175	40,91
202681	1	150	200	42,01

SET DE MORDAZAS DE PROTECCIÓN PARA TORNILLOS DE BANCO

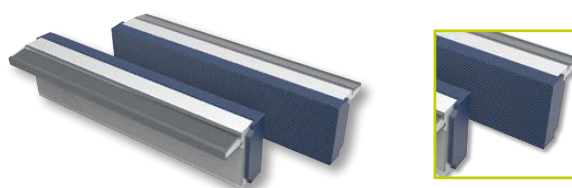

- Mordazas de poliuretano con pequeñas estrías cruzadas
- Para sujeción de piezas planas con detalles muy delicados
- Las mordazas están fabricadas con un material especial de poliuretano flexible
- Dureza Shore A82
- El poliuretano es conocido por sus habilidades únicas para "morder" la pieza de trabajo sin dañarla o rayarla
- El poliuretano es tan flexible que vuelve a su forma original después de la deformación
- Tira magnética de neodimio extremadamente potente

€			g	€
202761	1	100	150	38,05
202771	1	125	175	39,17
202781	1	150	200	40,73

BASE GIRATORIA TORNILLO DE BANCO



- Base giratoria para todos los modelos de guía redonda 201 y cuadrada 207041 / 207071 y 216

€		Ø mm	mm	L mm	d mm	g	€
201431	1	80	100	90	11	850	56,88
201451	1	100	125	115	13	1.150	86,79
201461	1	125	150	145	13	1.500	100,28
201471	1	150	175	165	17	2.500	130,19

TORNILLO DE SOBREMESA

TORNILLO DE BANCO DE SOBREMESA

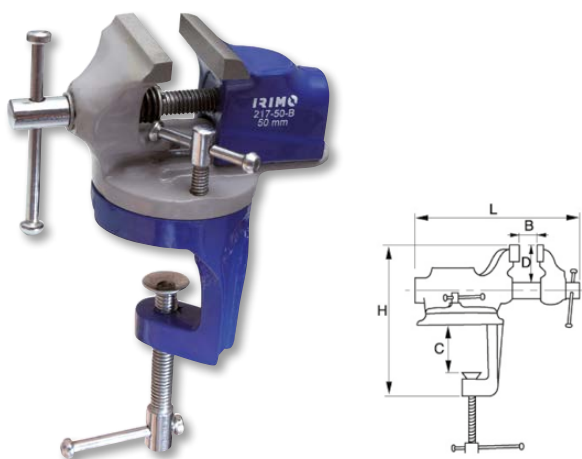

- Herramienta versatil
- Base giratoria
- Yunque acabado
- Material: hierro fundido
- En blister

€			B mm	C mm	D mm	H mm	L mm	g	€
217-50-B	1	50	40	34	20	120	125	1.100	36,26





APRIETOS DE ÉMBOLO

APRIETO MANGO DE MADERA



- Aprieto profesional con soporte fijo y corredizo y barra de acero galvanizada
- Mango de madera roscado para un ajuste cómodo
- Bocas forjadas que permiten una gran fuerza de forma constante

R		A mm	B mm	HxS mm	g	€
258-100-2	1	60	100	15.5x7.5	450	12,09
258-120-2	1	60	120	15.5x7.5	750	12,66
258-160-2	1	80	160	15.5x7.5	900	15,60
258-200-2	10	120	200	22x10.6	1.200	27,11
258-250-2	10	120	250	22x10.6	1.500	27,92
258-300-2	10	120	300	22x10.6	1.586	28,78

APRIETO DE 90 MM



R		A mm	B mm	HxS mm	g	€
256001	5	150	90	30x8	1.100	19,17
256011	5	200	90	30x8	1.200	20,59
256031	5	300	90	30x8	1.400	23,18
256041	5	400	90	30x8	1.600	25,50

APRIETO DE 120 MM

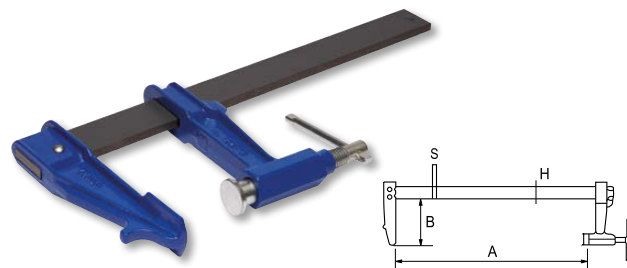

R		A mm	B mm	HxS mm	g	€
256131	5	300	120	35x8	2.000	24,95
256141	5	400	120	35x8	2.200	27,03
256151	5	500	120	35x8	2.400	29,47
256161	5	600	120	35x8	2.600	31,41
256181	5	800	120	35x8	3.000	36,05
256201	5	1.000	120	35x8	3.400	40,95

APRIETO DE 150 MM

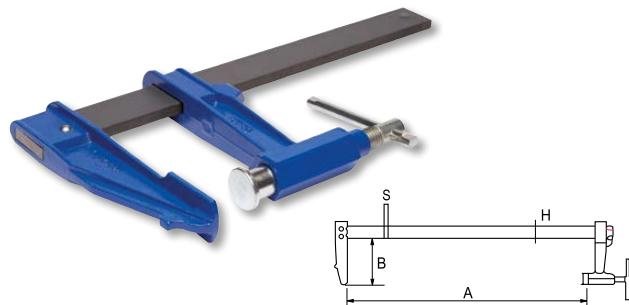

R		A mm	B mm	HxS mm	g	€
256231	5	300	150	40x10	3.100	44,67
256241	5	400	150	40x10	3.400	47,63
256251	2	500	150	40x10	3.700	50,37
256261	2	600	150	40x10	4.000	52,70
256281	2	800	150	40x10	4.600	57,78
256301	2	1.000	150	40x10	5.200	62,20
256321	1	1.200	150	40x10	5.800	66,01

TORNIQUETE DE MARQUETERÍA DE 70 MM

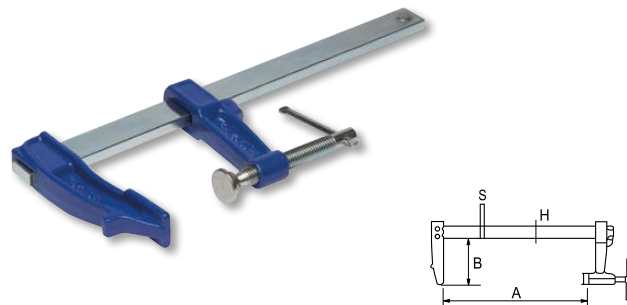

R		A mm	B mm	HxS mm	g	€
255011	10	120	70	18x7	420	11,58
255021	10	150	70	18x7	450	12,26
255031	10	200	70	18x7	500	13,21
255041	10	250	70	18x7	550	14,10
255051	10	300	70	18x7	600	15,32



APRIETO EXTRA FUERTE CON MECANISMO DE CARRACA

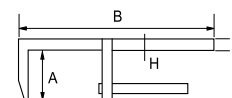

- Aprieto profesional
- Sujeción extra fuerte: 510 kg
- Cuerpo de aluminio
- Hasta 5100 Nw
- Mecanismo de carraca

🌀	📦	B mm	A mm	HxS mm	📄	€
257-200-2	10	200	140	25x12	986	59,86
257-300-2	10	300	140	25x12	1.586	63,31
257-400-2	10	400	140	25x12	2.286	66,03
257-500-2	10	500	140	25x12	2.886	70,10
257-600-2	10	600	140	25x12	3.286	73,44

MORDAZAS DE AJUSTE RÁPIDO

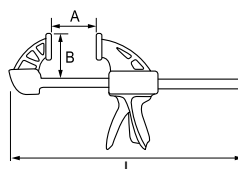

- Mordazas de alta resistencia con sistema de ajuste rápido
- Capacidad de sujeción: más de 60 kg
- Mordaza reversible



🌀	📦	A mm	B mm	L mm	📄	€
254-150-2	1	150 - 6"	60	335	487	7,82
254-300-2	6	300 - 12"	60	485	586	8,76
254-450-2	6	450 - 18"	60	635	686	10,44
254-600-2	6	600 - 24"	60	785	781	11,73
254-900-2	6	900 - 36"	60	1.085	980	15,17
254-1200-2	4	1.200 - 48"	60	1.685	1.165	15,22



06. HERRAMIENTAS PARA TUBO



LLAVES STILLSON

LLAVE STILLSON

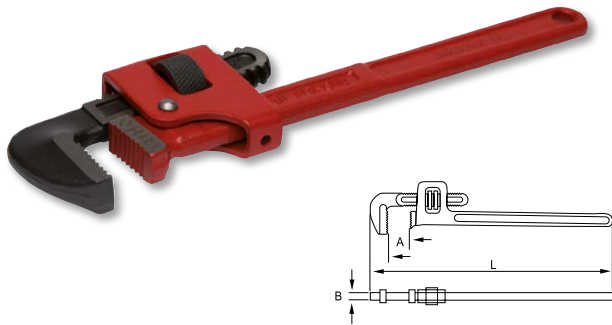

- Acero forjado
- Dentado de bocas templado a 55÷60 HRC
- Pintura epoxy de alta calidad

R	📦	A inch	A mm	B mm	L inch	L mm	g	€
302-210-2	3	1"	19	11	8"	210	290	15,59
302-260-2	3	1.3/8"	25	15	10"	260	620	17,34
302-310-2	3	1.3/4"	26	17	12"	310	800	20,23
302-365-2	3	2"	28	19	14"	365	1.120	21,68
302-465-2	1	2.3/8"	30	23	18"	465	1.890	30,34
302-615-2	1	3"	39	26	24"	615	3.200	50,42
302-900-2	1	4"	48	30	36"	900	6.100	97,05

LLAVE STILLSON DE ALUMINIO

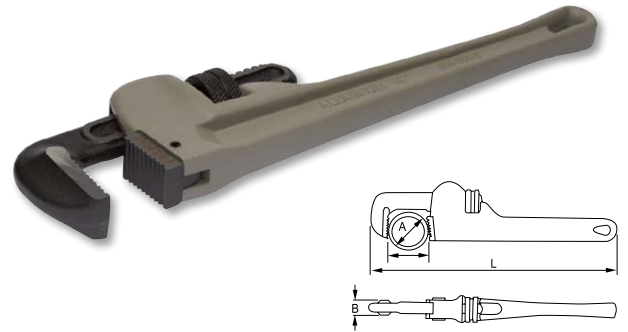

- Cuerpo de aleación de aluminio de alta resistencia con sección en doble T
- Ligera 40% menos de peso y alta resistencia

R	📦	A inch	A mm	B mm	L inch	L mm	g	€
304-250-2	2	1.1/2"	22	17	10"	250	430	24,18
304-350-2	2	2"	26	21	14"	350	950	32,15
304-450-2	1	2.1/2"	29	26	18"	450	1.650	45,91
304-600-2	1	3"	33	28	24"	600	2.500	76,50
304-900-2	1	5"	44	32	36"	900	5.200	147,98

REPUESTOS PARA LLAVE STILLSON



R	€	R	€	📦	L inch
302S-210-2	11,47	302T-210-2	9,57	1	8"
302S-260-2	15,93	302T-260-2	9,00	1	10"
302S-310-2	17,60	302T-310-2	9,05	1	12"
302S-365-2	17,72	302T-365-2	9,29	1	14"
302S-465-2	27,75	302T-465-2	9,69	1	18"
302S-615-2	38,85	302T-615-2	15,44	1	24"
302S-900-2	69,39	302T-900-2	23,92	1	36"

REPUESTOS PARA LLAVE STILLSON DE ALUMINIO



R	€	R	€	R	€	📦	L inch
304S-250-2	15,30	304T-250-2	6,22	304F-250-2	13,87	1	10"
304S-350-2	19,55	304T-350-2	7,43	304F-350-2	14,55	1	14"
304S-450-2	28,42	304T-450-2	9,98	304F-450-2	16,91	1	18"
304S-600-2	42,20	304T-600-2	13,90	304F-600-2	19,69	1	24"
304S-900-2	79,23	304T-900-2	24,63	304F-900-2	30,52	1	36"



LLAVE DE CADENA

LLAVE DE CADENA



- Cadena de acero especial templado de gran resistencia
- Función de bloqueo automático en ambas direcciones
- Funciona como una carraca en ambos sentidos

E		S	A mm	B mm	L mm	g	€
307-350-2	1	1.1/2"	8	38	350	1.400	97,33
307-685-2	1	2.1/2"	9	79	685	3.500	180,10
307-940-2	1	4"	13	60	940	6.700	229,60
307-1122-2	1	6"	20	75	1.122	12.600	396,50

CADENA DE REPUESTO



- Material: acero especial templado

E				€
307S-350-2	1	307-350-2	340	37,24
307S-685-2	1	307-685-2	475	51,96
307S-940-2	1	307-940-2	560	81,71
307S-1122-2	1	307-1122-2	830	172,75

LLAVES DE TUBO MODELO SUECO

BOCA INCLINADA

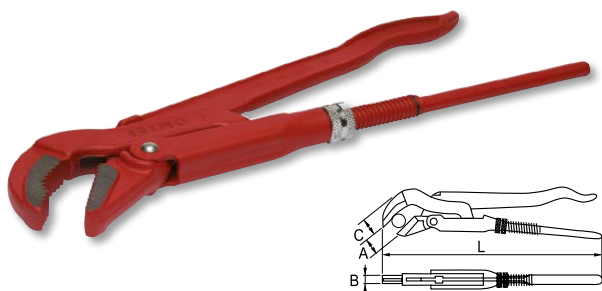

- Acero forjado
- Pintura epoxy
- Dientes templados

E		A inch	A mm	C mm	B mm	L mm	g	€
303081	1	1/2"	15	20	8	240	665	26,85
303111	1	1"	25	25	11	315	1.145	34,83
303121	1	1.1/2"	40	27	12	425	1.890	47,58
303131	1	2"	50	30	13	550	3.275	74,22
303171	1	3"	80	36	17	655	6.425	127,65

BOCA PERPENDICULAR

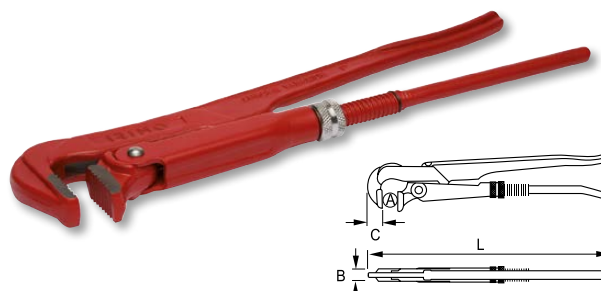

- Acero forjado
- Pintura epoxy
- Dientes templados

E		A inch	A mm	C mm	B mm	L mm	g	€
303201	1	1"	25	16	18	320	800	34,42
303211	1	1.1/2"	40	19	20	425	1.300	46,98
303221	1	2"	50	21	25	560	2.300	73,11
303231	1	3"	80	22	30	630	2.900	110,28
303241	1	4"	117	30	32	735	5.900	205,98

BOCA CURVADA

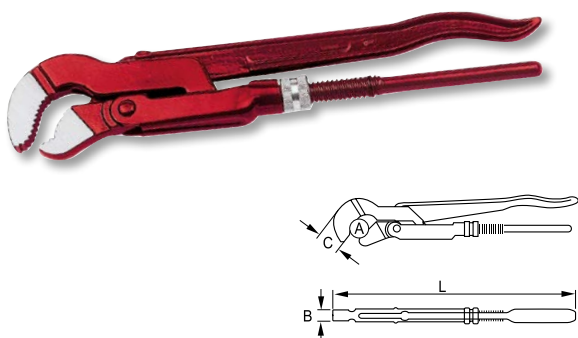

- Acero forjado
- Pintura epoxy
- Dientes templados

E		A inch	A mm	C mm	B mm	L mm	g	€
303291	1	1/2"	15	13	16	235	400	37,27
303301	1	1"	25	17	23	330	800	44,53
303311	1	1.1/2"	40	19	27	420	1.400	56,59
303321	1	2"	50	21	32	535	2.400	84,58
303331	1	3"	80	24	34	648	4.200	208,62



CORTATUBOS

MINI CORTATUBOS PARA TUBOS DE COBRE



- Esmaltado
- Fosfatado

R		S	Ø mm	L mm	g	€
321161	2	1/8" - 5/8"	3 - 16	58	122	14,55
321171	2	1/8" - 1.1/8"	3 - 30	80	220	17,85

CORTATUBOS UNIVERSAL

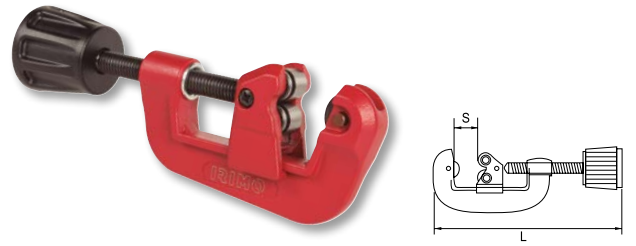

- Esmaltado
- Fosfatado

R		S	Ø mm	L mm	g	€
321281	1	1/8" - 1.1/8"	3 - 30	30	321	18,38

CORTATUBOS TELESCÓPICO PARA TUBOS DE COBRE



- Esmaltado
- Fosfatado

R		S	Ø mm	L mm	g	€
321361	1	1/8" - 1.3/8"	3 - 35	160	330	47,21

CORTATUBOS PARA TUBOS DE ACERO

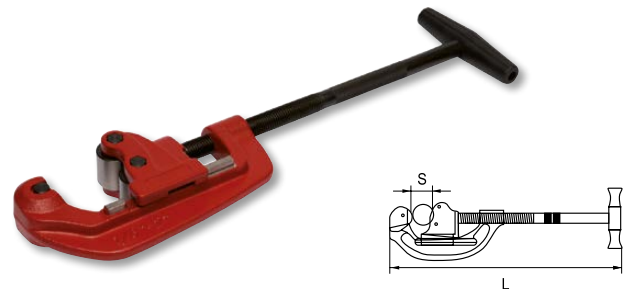

- Esmaltado
- Fosfatado

R		S	Ø mm	L mm	g	€
321501	1	1/8" - 2"	3 - 50	385	2.520	120,72

CUCHILLAS DE REPUESTO



R			D mm	d mm	E mm	g	€
321511	1	321161 / 321171 / 321281 / 321321 / 321351 / 321361	20	5	5	5	5,08
321551	1	321501	31	9	19	28	8,28

CORTATUBOS DE PLÁSTICO AUTO-RETRÁCTIL



- De 6 a 42 mm
- Utilizado para tubos de PVC, CPVC, POLY, PEX y PE
- Embalaje individual

R		L mm	g	€
321-42-1	12	205	680	58,10

CUCHILLA DE REPUESTO



- Cuchilla de repuesto para Cortatubos de plástico auto-retráctil
- Embalaje individual

R		g	€
321-BLADE-1	25	58	18,19



SACABOCADOS

JUEGO SACABOCADOS



332-51-4	1	11	140 x 130 x 40	680	88,04

333-003-2, 333-004-2, 333-006-2, 333-008-2, 333-010-2, 333-012-2, 333-014-2, 333-016-2, 333-018-2, 333-020-2	
332S-030-2	

JUEGO SACABOCADOS



332-52-4	1	16	140 x 130 x 40	680	159,63

333-003-2, 333-004-2, 333-006-2, 333-008-2, 333-010-2, 333-012-2, 333-014-2, 333-016-2, 333-018-2, 333-020-2, 333-022-2, 333-024-2, 333-026-2, 333-028-2, 333-030-2	
332S-030-2	

SACABOCADOS

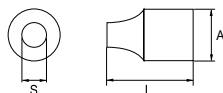

- Sacabocados intercambiables
- Para el corte de arandelas o juntas
- Cortan todos los materiales de juntas: cuero, goma, cartón, fibra, amianto, plomo, fieltro, plástico, etc.
- Triple afilado: Interno, externo y corte
- Bocas fabricadas en acero aleado y templadas en atmósfera protegida

		S mm		A mm	L mm		€
333-003-2	1	3	1/2 x 24 Z"	14	31	15	12,41
333-004-2	1	4	1/2 x 24 Z"	14	31	15	12,41
333-006-2	1	6	1/2 x 24 Z"	14	31	15	12,41
333-008-2	1	8	1/2 x 24 Z"	14	31	15	12,41
333-010-2	1	10	1/2 x 24 Z"	14	31	15	12,41
333-012-2	1	12	Lisa	25	30	30	18,45
333-014-2	1	14	Lisa	25	30	30	18,45
333-016-2	1	16	Lisa	25	30	30	18,45
333-018-2	1	18	Lisa	25	30	30	18,45
333-020-2	1	20	Lisa	25	30	30	18,45
333-022-2	1	22	Lisa	35	35	50	20,50
333-024-2	1	24	Lisa	35	35	50	20,50
333-026-2	1	26	Lisa	35	35	50	20,50
333-028-2	1	28	Lisa	35	35	50	20,50
333-030-2	1	30	Lisa	35	35	50	20,50

MANGO SACABOCADOS 3 - 30



332S-030-2	1	003-030 mm	350	12,41

REVÓLVER SACABOCADOS

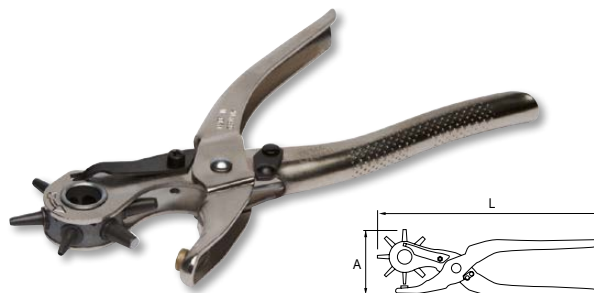

- Seis tamaños de perforación para materiales tan variados como cuero, caucho, lona, juntas y otros similares
- Fácil selección y visión del diámetro para evitar errores
- Su diseño único reduce la fuerza necesaria para el perforado en un 70%

		S	\emptyset mm	L mm		€
330021	1	1/8" - 2"	3 - 50	385	2.520	25,98



07. DESTORNILLADORES Y PUNTAS



DESTORNILLADORES



BOCA ESTAMPADA



- Mango: bi-material con agujero para colgar
- Varilla: templada y cromada fabricada en acero de alto rendimiento
- Punta: con tratamiento anti corrosión para mayor adherencia
- Marcado: código y tamaño marcado por láser en varilla
- ISO 2380

€	Icono	mm	mm	mm	mm	mm	g	€
407-4-75	10	0.8	4	75	90	165	40	3,37
407-4-100	10	0.8	4	100	90	190	40	3,43
407-5.5-100	10	1	5.5	100	100	200	65	4,28
407-5.5-125	10	1	5.5	125	100	225	70	4,42
407-6.5-125	10	1.2	6.5	125	110	235	100	5,52
407-6.5-150	10	1.2	6.5	150	110	260	105	6,19
407-8-150	10	1.6	8	150	110	260	119	6,96
407-8-175	10	1.6	8	175	110	285	127	7,13
407-10-200	10	1.6	10	200	120	320	175	9,16
407-12-250	5	2	12	250	120	370	230	11,87
407-14-250	5	2.5	14	250	120	370	260	14,75

BOCA FRESADA



- Mango: bi-material con agujero para colgar
- Varilla: templada y cromada fabricada en acero de alto rendimiento
- Punta: con tratamiento anti corrosión para mayor adherencia
- Marcado: código y tamaño marcado por láser en varilla
- ISO 2380

€	Icono	mm	mm	mm	mm	mm	g	€
408-2.5-75	10	0.4	2.5	75	90	165	34	2,47
408-3-75	10	0.5	3	75	90	165	35	2,75
408-3-100	10	0.5	3	100	90	190	40	2,96
408-3-200	5	0.5	3	200	90	290	45	4,28
408-3.5-100	10	0.6	3.5	100	90	190	40	3,06
408-4-100	10	0.8	4	100	90	190	45	3,52
408-4-125	10	0.8	4	125	90	215	45	3,55
408-4-250	5	0.8	4	250	90	340	60	5,39
408-5.5-125	10	1	5.5	125	100	225	65	4,42
408-5.5-150	10	1	5.5	150	100	250	90	4,97
408-5.5-300	5	1	5	300	100	400	106	6,36
408-6.5-150	10	1.2	6.5	150	110	260	110	5,98

EXTRACORTO BOCA FRESADA, RECTA



- Mango: bi-componente con agujero para colgar
- Varilla: templada y cromada fabricada en acero de alto rendimiento
- Punta: con tratamiento anti corrosión para mayor adherencia
- ISO 2380

€	Icono	mm	mm	mm	mm	mm	g	€
408-5.5-25	10	1.2	5.0	25	60	85	35	5,81
408-6.5-25	10	1.2	6.0	25	60	85	35	6,14



PHILLIPS



- Mango: bi-material con agujero para colgar
- Varilla: templada y cromada fabricada en acero de alto rendimiento
- Punta: con tratamiento anti corrosión para mayor adherencia
- Marcado: código y tamaño marcado por láser en varilla
- ISO 8764

€							€
409-0-75	10	PH-0	75	90	165	35	3,37
409-1-100	10	PH-1	100	100	200	65	4,12
409-2-125	10	PH-2	125	110	235	100	5,13
409-3-150	5	PH-3	150	120	270	160	7,94
409-4-200	5	PH-4	200	120	320	200	11,03
409-1-250	5	PH-1	250	100	350	89	6,19
409-2-300	5	PH-2	300	110	410	130	7,68

PHILLIPS EXTRA CORTO



- Mango: bi-componente con agujero para colgar
- Varilla: templada y cromada fabricada en acero de alto rendimiento
- Punta: con tratamiento anti corrosión para mayor adherencia
- ISO 8764

€							€
409-1-25	10	PH-1	25	60	85	35	6,03
409-2-25	10	PH-2	25	60	85	35	6,24

POZIDRIV



- Mango: bi-material con agujero para colgar
- Varilla: templada y cromada fabricada en acero de alto rendimiento
- Punta: con tratamiento anti corrosión para mayor adherencia
- Marcado: código y tamaño marcado por láser en varilla
- ISO 8764

€							€
413-0-75	5	PZ-0	75	90	165	35	3,98
413-1-100	5	PZ-1	100	100	200	75	4,58
413-2-125	5	PZ-2	125	110	235	100	5,56
413-3-150	5	PZ-3	150	120	270	160	8,27
413-4-200	5	PZ-4	200	120	270	205	10,50

POZIDRIV EXTRA CORTO



- Mango: bi-componente con agujero para colgar
- Varilla: templada y cromada fabricada en acero de alto rendimiento
- Punta: con tratamiento anti corrosión para mayor adherencia
- ISO 8764

€							€
413-1-25	10	PZ-1	25	60	85	35	5,11
413-2-25	10	PZ-2	25	60	85	35	5,11





DESTORNILLADORES

TORX®



- Mango: bi-material con agujero para colgar
- Varilla: templada y cromada fabricada en acero de alto rendimiento
- Punta: Negra de elevada precisión
- Marcado: código y tamaño marcado por láser en varilla

Artículo	Paquete	Tamaño	Diámetro (mm)	Longitud (mm)	Longitud (mm)	Longitud (mm)	Peso (g)	€
414-5-75	10	T-5	2.5	75	90	165	32	4,76
414-6-75	10	T-6	3	75	90	165	35	3,62
414-7-75	10	T-7	3	75	90	165	35	3,62
414-8-75	10	T-8	3	75	90	165	35	3,62
414-9-75	10	T-9	3	75	90	165	35	3,62
414-10-75	10	T-10	3	75	90	165	35	4,38
414-15-100	10	T-15	3.5	100	90	190	45	4,58
414-20-100	10	T-20	4	100	90	190	45	4,62
414-25-125	10	T-25	5	125	100	225	70	5,43
414-27-125	10	T-27	5.5	125	100	225	70	5,39
414-30-150	10	T-30	6	150	110	260	105	6,49
414-40-150	5	T-40	7	150	110	260	120	7,89
414-45-150	5	T-45	7	150	110	260	120	8,29

DESTORNILLADOR STECKER



- Mango: bi-material con agujero para colgar
- Varilla: templada 100% y cromada fabricada en acero de alto rendimiento
- Punta: con tratamiento anti corrosión para mayor adherencia
- Marcado: código y tamaño marcado por láser en varilla
- ISO 691

Artículo	Paquete	Tamaño	Diámetro (mm)	Longitud (mm)	Longitud (mm)	Longitud (mm)	Peso (g)	€
417-3.2-125	5	3.2	5.7	125	90	215	60	9,59
417-4-125	5	4	6.9	125	90	215	60	8,82
417-4.5-125	5	4.5	7.5	125	90	215	60	8,82
417-5-125	5	5	8.2	125	100	250	70	9,16
417-5.5-125	5	5.5	8.8	125	100	250	70	9,16
417-6-125	5	6	9.4	125	100	250	70	9,16
417-7-125	5	7	11.0	125	110	260	120	10,26
417-8-125	5	8	12.2	125	110	260	120	10,52
417-9-125	5	9	13.5	125	110	260	120	11,12
417-10-125	5	10	14.7	125	110	260	120	11,62
417-11-125	5	11	16.0	125	120	270	155	12,64
417-12-125	5	12	17.2	125	120	270	155	13,07
417-13-125	5	13	18.5	125	120	270	155	15,01
417-14-125	5	14	19.7	125	120	270	155	15,61

PORTAPUNTAS MAGNÉTICO PARA PUNTAS 1/4"



- Mango: bi-material con agujero para colgar
- Varilla: templada y cromada fabricada en acero de alto rendimiento
- Imán fuerte
- Marcado: código y tamaño marcado por láser en varilla

Artículo	Paquete	Tamaño	Longitud (mm)	Longitud (mm)	Peso (g)	€
475-1/4-125	5	1/4"	125	235	112	17,19



- Mango: bi-material con agujero para colgar
- Varilla: templada y cromada fabricada en acero de alto rendimiento
- Con muelle retención

Artículo	Paquete	Tamaño	Longitud (mm)	Longitud (mm)	Peso (g)	€
475-1/4F-160	5	1/4"	160	270	135	17,04



STECKER FLEXIBLE



• Mango: bi-material con agujero para colgar

E						€
190-6-135	1	6	135	260	125	17,39
190-7-135	1	7	135	270	125	17,39
190-8-135	1	8	135	270	125	17,39
190-10-135	1	10	135	270	125	17,39

DESTORNILLADORES DE CARRACA PARA 12 PUNTAS DE 1/4"

DESTORNILLADOR DE CARRACA CON COMPARTIMENTO PARA 12 PUNTAS DE 1/4"

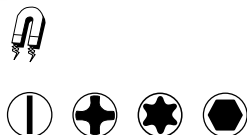

- Mango: bi-material
- Compartimento de almacenamiento para intercambiar puntas con botón de liberación rápida
- Compartimento deslizable con 12 puntas diferentes: Ranurado 4, 5, 6 mm; PH 1, 2, 3; TORX® 15, 20, 25; Hex 3, 4, 5 mm
- El imán asegura las puntas al de destornillador
- Golpe de carraca suave
- Mecanismo de carraca de tres posiciones: avance, retroceso y neutral

E						€	
475R-1/4-110	6	1/4"	110	125	235	310	18,06

DESTORNILLADOR A CARRACA MANGO CARROCERO



- Destornillador porta puntas a carraca con mango de carrocerero
- Mango: bi-componente
- Compartimento para puntas intercambiables
- 6 puntas dobles de 1/4": Planas 5.0, 6.0 mm; PH1, PH2; T15, T20, T25, T30; Hex 2.5, 3, 4, 5 mm
- La varilla magnética asegura las puntas en el destornillador
- Carraca de trinquete suave. Mecanismo de 3 posiciones
- En blister

E						€	
475R-1/4-30	6	1/4"	30	80	110	192	15,81



DESTORNILLADORES AISLADOS 1000 V

BOCA PLANA



- Para trabajos en baja tensión hasta 1000V
- Mango: Bi-material con agujero para coger
- Varilla: Acero aleado de alto rendimiento, con recubrimiento aplicado directamente sobre la varilla
- Punta negra protegida con mayor precisión
- Marcado: Tamaño y código marcado por láser en varilla
- ISO 2380

R		mm	mm	mm	mm	mm	g	€
408V-2.5-100	10	0.4	2.5	100	90	165	20	4,32
408V-3-100	10	0.5	3	100	90	190	22	4,45
408V-3.5-100	10	0.6	3.5	100	90	190	32	4,67
408V-4-100	10	0.8	4	100	90	190	35	4,83
408V-5.5-125	10	1	5.5	125	100	225	65	6,54
408V-6.5-150	10	1.2	6.5	150	110	260	90	7,42
408V-8-175	5	1.2	8	175	120	295	110	8,49

PHILLIPS



- Para trabajos en baja tensión hasta 1000V
- Mango: Bi-material con agujero para coger
- Varilla: Acero aleado de alto rendimiento, con recubrimiento aplicado directamente sobre la varilla
- Punta negra protegida con mayor precisión
- Marcado: Tamaño y código marcado por láser en varilla
- ISO 8764

R			mm	mm	mm	mm	g	€
409V-0-100	10	PH-0	100	90	190	40	4,42	
409V-1-150	10	PH-1	150	100	260	80	5,52	
409V-2-175	10	PH-2	175	110	285	120	7,29	
409V-3-200	5	PH-3	200	120	320	180	8,84	

POZIDRIV



- Para trabajos en baja tensión hasta 1000V
- Mango: Bi-material con agujero para coger
- Varilla: Acero aleado de alto rendimiento, con recubrimiento aplicado directamente sobre la varilla
- Punta negra protegida con mayor precisión
- Marcado: Tamaño y código marcado por láser en varilla
- ISO 8764

R			mm	mm	mm	mm	g	€
413V-0-100	10	PZ-0	100	90	190	40	5,05	
413V-1-150	10	PZ-1	150	100	260	80	6,32	
413V-2-175	10	PZ-2	175	110	285	120	7,29	
413V-3-200	5	PZ-3	200	120	320	180	8,84	

TORX®



- Para trabajos en baja tensión hasta 1000V
- Mango: Bi-material con agujero para coger
- Varilla: Acero aleado de alto rendimiento, con recubrimiento aplicado directamente sobre la varilla
- Punta negra protegida con mayor precisión
- Marcado: Tamaño y código marcado por láser en varilla
- ISO 8764

R			mm	mm	mm	mm	g	€
414V-10-100	10	T-10	100	90	190	320	5,32	
414V-15-125	10	T-15	125	100	225	650	6,65	
414V-20-125	10	T-20	125	100	225	750	7,68	
414V-25-150	10	T-25	150	110	360	900	9,30	



JUEGO 2 DESTORNILLADORES AISLADOS + TESTER

IEC 60900

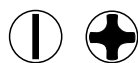

- Juego de destornilladores, 3 piezas
- Para tornillos de cabeza recta y Phillips

					€
459V-3-1	1	3	35x130x310	35	19,34
408V-4-100					
409V-1-150					
429-03-1					

JUEGOS DE DESTORNILLADORES

JUEGO PLANO-PHILLIPS, 6 piezas

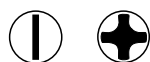

- Para tornillos planos y Phillips
- En caja de cartón

					€
459-6-C	1	6	42x325x160	570	26,39
408-3-75, 408-4-100					
407-5.5-125, 407-6.5-150					
409-1-100, 409-2-125					

JUEGO PLANO-POZIDRIV PARA MECÁNICO, 6 piezas



- Para tornillos planos y Pozidriv
- En caja de cartón

					€
459-6A-C	1	6	42x325x160	570	26,39
408-3-75, 408-4-100					
407-5.5-125, 407-6.5-150					
413-1-100, 413-2-125					





JUEGOS DE DESTORNILLADORES

JUEGO PLANO-PHILLIPS, 5 piezas

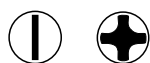

- Para tornillos planos y Phillips
- Embalaje en blíster

€	Icono	X	Icono	g	€
459-5-B	1	5		435	21,76
408-3-75, 408-4-100			⊖		
407-6.5-150			⊖		
409-1-100, 409-2-125			⊕		

JUEGO TORX®, 6 piezas



- Para tornillos TORX®
- En caja de cartón

€	Icono	X	Icono	g	€
459-6B-C	1	6	42 x 325 x 160	470	30,91
414-10-75, 414-15-100, 414-20-100, 414-25-125, 414-27-125, 414-30-150			⊗		

JUEGO PLANO-POZIDRIV PARA ELECTRICISTA, 6 piezas



- Para tornillos planos y Phillips
- En caja de cartón

€	Icono	X	Icono	g	€
459-6C-C	1	6	42 x 325 x 160	505	25,31
408-3-100, 408-4-125, 408-5.5-150			⊖		
409-1-100, 409-2-125			⊕		
429-03-1			⊖		



EXPOSITORES DE DESTORNILLADORES

EXPOSITOR 83 DESTORNILLADORES

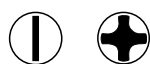

- Display de 83 destornilladores
- Para tornillos planos y Phillips

IRIMO	Paquete	Caja	Paquete	g	€
910-83DISP	1	83	500x450x250	8.500	397,36
MEE-COUNT-IR-2	expositor vacio				-
8x 408-3-75, 8x 408-4-100, 6x 408-5.5-150, 7x 408-6.5-150				⊖	
6x 407-10-200, 8x 407-4-100, 7x 407-5.5-125, 6x 407-6.5-150, 6x 407-8-175				⊖	
8x 409-0-75, 7x 409-1-100, 6x 409-2-125				⊕	

EXPOSITOR 152 DESTORNILLADORES



- Display de 152 destornilladores
- Para tornillos planos, Phillips y TORX®

IRIMO	Paquete	Caja	Paquete	g	€
910-152DISP	1	152	775x450x250	14.100	686,75
MEE-COUNT-IR-3	expositor vacio				-
8x 408-2.5-75, 8x 408-3.5-100, 8x 408-3-75, 8x 408-4-100, 7x 408-5.5-125, 6x 408-6.5-150				⊖	
6x 407-10-200, 8x 407-4-100, 7x 407-5.5-125, 6x 407-6.5-150, 6x 407-8-175				⊖	
6x 408-6.5-25				⊖	
8x 409-0-75, 7x 409-1-100, 6x 409-2-125, 6x 409-3-150				⊕	
6x 409-2-25				⊕	
8x 414-10, 7x 414-15, 7x 414-20, 7x 414-25, 6x 414-30				⊗	





JUEGOS DE DESTORNILLADORES DE SEGURIDAD

JUEGO PLANO-PHILLIPS, 6 piezas

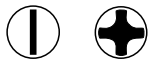

- Para tornillos planos y Phillips
- En caja de cartón

€	Icono	X	Icono	g	€
459V-6-C	1	6	42x325x160	580	39,18
408V-2.5-100, 408V-4-100, 408V-5.5-125, 408V-6.5-150	1				
409V-1-150, 409V-2-175					

EXPOSITORES DE DESTORNILLADORES

EXPOSITOR 72 DESTORNILLADORES DE SEGURIDAD

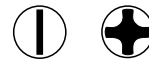

- Display de 72 destornilladores de seguridad
- Para tornillos planos y Phillips

€	Icono	X	Icono	g	€
910V-72DISP	1	72	500x450x250	9.075	409,21
MEE-COUNT-IR-2			expositor vacío		-
8x 408V-2.5-100, 8x 408V-3.5-100, 8x 408V-3-100, 8x 408V-4-100, 7x 408V-5.5-125, 6x 408V-6.5-150, 6x 408V-8-175	1				
8x 409V-0-100, 7x 409V-1-150, 6x 409V-2-175					

DESTORNILLADORES MANGOS EN T

HEXAGONAL



- Varilla: Acero de alta Calidad. Punta negra con mayor precisión
- La longitud de varilla permite aplicar un par controlado y mayor accesibilidad
- La varilla corta del mango a 90° se utiliza para pares muy fuertes o donde zona de trabajo tiene una altura limitada
- Marcado: Tamaño y código marcado por láser en varilla
- Arandela giratoria muy práctica y útil en la base del mango para un giro rápido en la primera fase del apriete

€	Icono	Icono	Icono	Icono	Icono	g	€
42-H2-100	5	2	130	100	64x30	23	6,45
42-H2.5-100	5	2.5	130	100	64x30	25	6,45
42-H3-100	5	3	130	100	64x30	28	6,52
42-H4-150	5	4	190	150	80x40	57	7,38
42-H5-150	5	5	190	150	80x40	70	7,69
42-H6-200	5	6	250	200	100x50	134	11,05
42-H8-200	5	8	250	200	100x50	186	12,11
42-H10-200	5	10	250	200	100x50	254	13,40



TORX®



- Varilla: Acero de alta Calidad. Punta negra con mayor precisión
- La longitud de varilla permite aplicar un par controlado y mayor accesibilidad
- La varilla corta del mango a 90° se utiliza para pares muy fuertes o donde zona de trabajo tiene una altura limitada
- Marcado: Tamaño y código marcado por láser en varilla
- Arandela giratoria muy práctica y útil en la base del mango para un giro rápido en la primera fase del apriete

Q	Icono	Tamaño	Longitud (mm)	Longitud (mm)	Longitud (mm)	Peso (g)	€	
46-T10-100	5	T10	2.72	130	100	64x30	27	7,96
46-T15-150	5	T15	3.26	190	150	80x40	55	8,62
46-T20-150	5	T20	3.84	190	150	80x40	55	8,88
46-T25-150	5	T25	4.40	190	150	80x40	66	9,48
46-T30-200	5	T30	5.49	250	200	100x50	126	9,80
46-T40-200	5	T40	6.60	250	200	100x50	147	10,66

LLAVE DE VASO MANGO EN T



- Varilla templada en su total longitud fabricada en acero de alta calidad
- Marcado: Tamaño y código marcado por láser en varilla
- Arandela giratoria muy práctica y útil en la base del mango para un giro rápido en la primera fase del apriete

Q	Icono	Tamaño	Longitud (mm)	Longitud (mm)	Longitud (mm)	Peso (g)	€
191-6-150	5	6	190	150	69x40	78	10,74
191-7-175	5	7	225	175	84x50	121	11,61
191-8-175	5	8	225	175	84x50	123	11,81
191-10-175	5	10	225	175	84x50	160	12,54
191-12-175	5	12	225	175	84x50	167	13,89
191-13-175	5	13	225	175	84x50	172	14,81

HEXAGONAL BOLA



- Acero de alta calidad. Acabado en negro
- La varilla larga permite un apriete controlado y facil acceso a los tornillos que requieren profundidad
- La varilla corta de 90° se usa para aprietes fuertes o para trabajar en espacios limitados
- La bola permite introducir la cabeza en el tornillo desde diferentes ángulos
- Más eficiente que el mango en T estándar
- Código y tamaño marcado a láser en varilla para fácil identificación

Q	Icono	Tamaño	Longitud (mm)	Longitud (mm)	Longitud (mm)	Peso (g)	€
42B-H3-100	5	3	130	100	64x30	28	6,96
42B-H4-150	5	4	190	150	80x40	57	7,89
42B-H5-150	5	5	190	150	80x40	70	8,20
42B-H6-200	5	6	250	200	100x50	134	11,79
42B-H8-200	5	8	250	200	100x50	186	12,92
42B-H10-200	5	10	250	200	100x50	254	14,32

JUEGO DE 6 DESTORNILLADORES LLAVES ALLEN, MANGO EN T

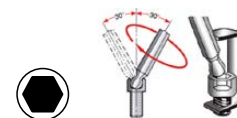

- Mango en T con bola hexagonal
- En blister

Q	Icono	Tamaño	Longitud (mm)	Peso (g)	€
42B-6-B	1	6	355x247x40	120	62,09

42B-H10-200, 42B-H3-100, 42B-H4-150, 42B-H5-150, 42B-H6-200, 42B-H8-200





DESTORNILLADOR 6 EN 1



- Puntas dobles (6,35 x 65 mm): PH1-5 mm
- Puntas dobles (8 x 75 mm): PH2-6 mm
- Destornillador Stecker: 6, 8 mm

475-5-1	1	1/4" / 5/16"	50	110	160	312	6,95

DESTORNILLADOR REVERSIBLE



- Mango: plástico de alta resistencia a impactos
- Varilla nickelada

427411	10	1.2	6	PH-2	156	26	4,01

MAGNETIZADOR – DESMAGNETIZADOR



- Para magnetizar y desmagnetizar diferentes herramientas
- Dispositivo pequeño de fácil manejo
- Material: magnético, plástico
- En blíster

458-02-1	5	53x50x30	164	4,57



DESTORNILLADORES DE PRECISIÓN

JUEGO DE 6 DESTORNILLADOR DE PRECISIÓN



ABRIR
CERRAR



- Juego destornilladores de precisión, 6 piezas
- Varillas de acero cromo-vanadio
- Acabado cromado con punta negra para mayor precisión
- Cabeza giratoria
- Sistema de deslizamiento de la caja para abrir y cerrar
- Medidas incluidas:
 - 4 planos: 1,6-2,0-5,5-3,0 mm
 - 2 Phillips: PH00-PH0

IRIMO	Icono	mm	mm	g	€
461-6-B	1	150	50	120	11,28

DESTORNILLADOR DE PRECISIÓN DE BOLSILLO



478-4-1



478-4-2



- 2 varillas cortas
- 4 puntas: PH0 / 3 mm y PH1 / 4 mm
- Acabado satinado con tratamiento en la punta
- Tamaño de boli con clip incluido para llevarlo fácilmente
- 478-4-2: Expositor de 48 destornilladores doble boca

IRIMO	Icono	mm	mm	mm	g	€
478-4-1	1	PH0/PH1	120	3.0/4.0	20	3,88
478-4-2	48	PH0/PH1	120	3.0/4.0	1.100	3,27

BUSCAPOLOS



429-03-1
429-04-1



429-10-1

- Mango: Transparente resistente a impactos
- Varilla: niquelada y protegida hasta la punta
- Fabricado según normativa DIN VDE 0680/6 GS
- 429-10-1: tester 6-24V

IRIMO	Icono	mm	mm	mm	mm	mm	g	€
429-03-1	6	0.6	3.0	65	75	140	30	3,85
429-04-1	6	-	3.5	100	90	190	29	3,78
429-10-1	6	-	3.0	45	75	120	22	4,72



LLAVES TIPO ALLEN NIQUELADAS

LLAVES TIPO ALLEN NIQUELADAS, MÉTRICA



- Niquelada
- Tamaño marcado en la varilla
- ISO 2936

€			a mm	b mm		€
040001	10	1.5	15	47	1	0,45
040011	10	2.0	18	52	1	0,46
040021	10	2.5	21	59	3	0,54
040031	10	3.0	23	66	4	0,60
040041	10	4.0	29	74	10	0,73
040051	10	5.0	33	85	18	0,85
040061	10	6.0	38	96	29	1,02
040071	10	7.0	41	102	41	1,39
040081	10	8.0	44	108	57	1,91
040091	5	9.0	47	114	76	2,11
040101	5	10.0	50	122	100	2,67
040121	5	12.0	57	137	163	3,91
040141	1	14.0	70	154	253	5,26
040171	1	17.0	80	177	427	7,43
040191	1	19.0	89	199	600	12,56
040221	1	22.0	102	222	910	18,58

LLAVES TIPO ALLEN NIQUELADAS, PULGADAS



- Niquelada
- Tamaño marcado en la varilla
- ISO 2936

€			a mm	b mm		€
040541	10	1/16"	15	47	1	0,50
040011	10	5/64"	18	52	1	0,46
040561	10	3/32"	21	59	3	0,65
040581	10	1/8"	23	66	4	0,73
040041	10	5/32"	29	74	10	0,73
040601	10	3/16"	33	85	18	1,06
040611	10	7/32"	35.5	91	29	1,29
040621	10	1/4"	38	96	32	1,57
040641	10	5/16"	44	108	60	1,96
040661	5	3/8"	50	122	100	2,74
040681	5	7/16"	53	129	140	3,35
040701	5	1/2"	63	145	182	4,09
040731	1	5/8"	76	168	370	6,87
040191	1	3/4"	89	199	601	12,56

JUEGOS LLAVES TIPO ALLEN MÉTRICA EN BOLSA



- En bolsa de plástico
- Tamaño marcado en la bolsa para fácil selección
- Agujero para colgar

€					€
041011	1	6	2.0, 2.5, 3.0, 4.0, 5.0, 6.0 mm	76	6,95
041071	1	8	2.0, 2.5, 3.0, 4.0, 5.0, 6.0, 7.0, 8.0 mm	180	11,60
041021	1	10	2.0, 2.5, 3.0, 4.0, 5.0, 6.0, 7.0, 8.0, 10, 12 mm	380	15,24
041091	1	11	2.0, 2.5, 3.0, 4.0, 5.0, 6.0, 7.0, 8.0, 9.0, 10, 12 mm	570	20,43
041031	1	13	2.0, 2.5, 3.0, 4.0, 5.0, 6.0, 7.0, 8.0, 10, 12, 14, 17, 19 mm	1.800	41,86
041101	1	15	2.0, 2.5, 3.0, 4.0, 5.0, 6.0, 7.0, 8.0, 9.0, 10, 12, 14, 17, 19, 22 mm	2.920	65,54

JUEGOS LLAVES TIPO ALLEN PULGADAS EN BOLSA



- En bolsa de plástico
- Tamaño marcado en la bolsa para fácil selección
- Agujero para colgar

€					€
041041	1	5	1/8, 5/32, 3/16, 7/32, 1/4"	95	8,53
041051	1	9	1/8, 5/32, 3/16, 7/32, 1/4, 5/16, 3/8, 7/16, 1/2"	580	20,67
041061	1	12	1/8, 5/32, 3/16, 7/32, 1/4, 5/16, 3/8, 7/16, 1/2, 9/16, 5/8, 3/4"	1.865	44,52



JUEGOS LLAVES TIPO ALLEN NIQUELADAS, EN LLAVERO



• En llavero

R	📦	📦	🔧	g	€
041111	1	6	2-2.5-3-4-5-6 mm	77	9,46
041121	1	8	2-2.5-3-4-5-6-8-10 mm	240	13,80

JUEGO 3 DESTORNILLADORES ACODADOS DOBLES, 3 piezas



- 3 piezas con doble punta (recta y PH)
 - Planas: 5.0, 6.0, 8.0 mm
 - Phillips: PH1, PH2, PH3
- Acabado cromado
- En blíster

R	📦	📦	📦	g	€
420-3-1	1	3	20x230x100	202	8,52

LLAVES TIPO ALLEN CROMADAS, LARGAS

JUEVO LLAVES TIPO ALLEN CROMADAS PARA TORNILLOS HEXAGONALES, ACABADO EN BOLA, EN MM



- Juego de 9 llaves largas con bola, en mm
- Tamaños marcados en la tapa para su fácil identificación
- Embalaje en blíster

R	📦	📦	🔧	g	€
48-9C-H	1	9	1.5-2-2.5-3-4-5-6-8-10 mm	360	15,52

LLAVES TIPO ALLEN PAVONADAS

LLAVES TIPO ALLEN PAVONADAS, MÉTRICA



- Pavonada
- Tamaño marcado en la varilla
- ISO 2936

R	📦	🔧	a mm	b mm	g	€
045001	10	1.5	15	47	1	0,45
045011	10	2.0	18	52	2	0,45
045021	10	2.5	21	59	3	0,51
045031	10	3.0	23	66	4	0,60
045041	10	4.0	29	74	10	0,61
045051	10	5.0	33	85	13	0,89
045061	10	6.0	38	95	29	1,08
045071	10	7.0	41	102	41	1,48
045081	10	8.0	44	105	57	1,68
045091	5	9.0	47	114	76	2,27
045101	5	10.0	50	122	100	2,36
045121	5	12.0	57	137	163	3,48
045141	1	14.0	70	154	253	4,89
045171	1	17.0	80	177	427	7,83
045191	1	19.0	89	199	600	11,02
045221	1	22.0	102	222	910	17,63



LLAVES TIPO ALLEN PAVONADAS

LLAVES TIPO ALLEN PAVONADAS, MÉTRICA

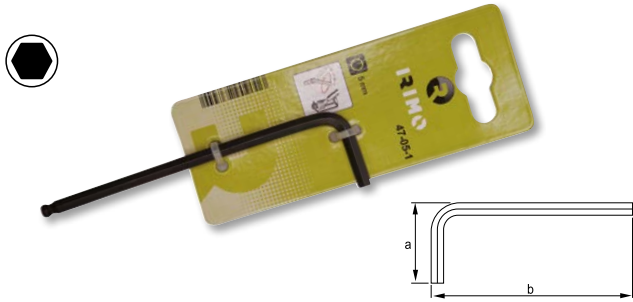

- Aleación de acero de alto rendimiento
- Pavonada
- Tamaño marcado en la varilla
- ISO 2936

R	📦	📏	a mm	b mm	g	€
45-00-1	1	1.5	14.5	45.5	5.4	0,51
45-01-1	1	2.0	27.0	51.0	6.4	0,51
45-02-1	1	2.5	19.5	55.5	7.5	0,56
45-03-1	1	3.0	22.0	64.0	9.4	0,65
45-04-1	1	4.0	28.0	72.0	14.4	0,66
45-05-1	1	5.0	22.0	83.0	22.4	0,95
45-06-1	1	6.0	38.0	94.0	33.8	1,14
45-08-1	1	7.0	37.0	105.0	63.8	1,73
45-10-1	1	10.0	49.0	119.0	107.3	2,42

JUEGOS LLAVES TIPO ALLEN PAVONADAS, MM



- En bolsa de plástico
- Tamaño marcado en la bolsa para fácil selección
- Agujero para colgar

R	📦	📏	📏	g	€
046011	1	6	2.0, 2.5, 3.0, 4.0, 5.0, 6.0 mm	76	6,00
046021	1	10	2.0, 2.5, 3.0, 4.0, 5.0, 6.0, 7.0, 8.0, 10, 12 mm	180	14,68
046091	1	11	2.0, 2.5, 3.0, 4.0, 5.0, 6.0, 7.0, 8.0, 9.0, 10, 12 mm	460	18,04
046031	1	13	2.0, 2.5, 3.0, 4.0, 5.0, 6.0, 7.0, 8.0, 10, 12, 17, 19 mm	1.805	38,62
046101	1	15	2.0, 2.5, 3.0, 4.0, 5.0, 6.0, 7.0, 8.0, 9.0, 10, 12, 14, 17, 19, 22 mm	2.830	60,82

JUEGOS LLAVES TIPO ALLEN PAVONADAS, MM



- Juego de 9 llaves hex pavonadas, mm
- Tamaño marcados en el plástico para su fácil identificación
- Embalaje en blíster

R	📦	📏	📏	g	€
46-9-H	1	9	1.5, 2, 2.5, 3, 4, 5, 6, 8, 10 mm	270	7,56

JUEGOS LLAVES TIPO ALLEN PAVONADAS, MM



- Juego de 8 llaves hex pavonadas, mm
- Presentado en navaja
- Permite diversas posiciones de trabajo
- Tope a los 270°, máximo ángulo de giro
- De fácil almacenaje

R	📦	📏	📏	g	€
46-8-F	1	8	1.5, 2.0, 2.5, 3.0, 4.0, 5.0, 6.0, 8.0 mm	160	10,85



LLAVES TIPO ALLEN PAVONADAS, PULGADAS



- Pavonadas
- Tamaño impreso en la varilla para su fácil identificación
- ISO 2936

R			a mm	b mm	g	€
045541	10	1/16"	15	47	1	0,46
045011	10	5/64"	18	52	2	0,45
045561	10	3/32"	21	59	3	0,39
045581	10	1/8"	23	66	5	0,46
045041	10	5/32"	29	74	10	0,61
045601	10	3/16"	33	85	16	0,64
045611	10	7/32"	35.5	91	24	0,87
045621	10	1/4"	38	96	32	1,42
045641	10	5/16"	44	105	60	1,70
045661	5	3/8"	50	122	100	2,34
045681	5	7/16"	53	129	140	2,95
045701	5	1/2"	63	145	182	3,59
045731	1	5/8"	76	168	370	6,05
045191	1	3/4"	89	199	601	11,02

JUEGOS LLAVES TIPO ALLEN PAVONADAS, PULGADAS



- En bolsa de plástico
- Tamaño marcado en la bolsa para fácil selección
- Agujero para colgar

R				g	€
046041	1	5	1/8, 5/32, 3/16, 7/32, 1/4"	95	7,85
046051	1	9	1/8, 5/32, 3/16, 7/32, 1/4, 5/16, 3/8, 7/16, 1/2"	580	18,69
046061	1	12	3/32, 1/8, 5/32, 3/16, 7/32, 1/4, 5/16, 3/8, 7/16, 1/2, 5/8, 3/4"	1.865	39,99

LLAVES TIPO ALLEN PAVONADAS, LARGAS

LLAVES TIPO ALLEN PAVONADAS, LARGAS, MÉTRICA

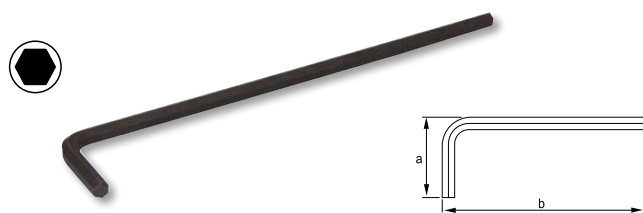

- Tamaño marcado en la varilla para fácil identificación
- La mayor longitud permite mejor accesibilidad y mayor par de transmisión
- ISO 2936

R			a mm	b mm	g	€
045801	10	1.5	15	91	1	0,50
045811	10	2.0	18	102	3	0,52
045821	10	2.5	21	114	5	0,56
045831	10	3.0	23	129	8	0,70
045841	10	4.0	29	144	17	0,81
045851	10	5.0	33	165	31	1,02
045861	10	6.0	38	186	51	1,72
045871	10	7.0	41	197	64	2,55
045881	5	8.0	44	208	100	2,96
045891	5	9.0	47	219	134	3,72
045901	5	10.0	50	234	175	4,31
045921	2	12.0	57	262	283	6,29
045941	2	14.0	70	294	439	8,05





LLAVES TIPO ALLEN PAVONADAS, LARGAS

LLAVES TIPO ALLEN PAVONADAS, LARGAS, MÉTRICA CON BOLA

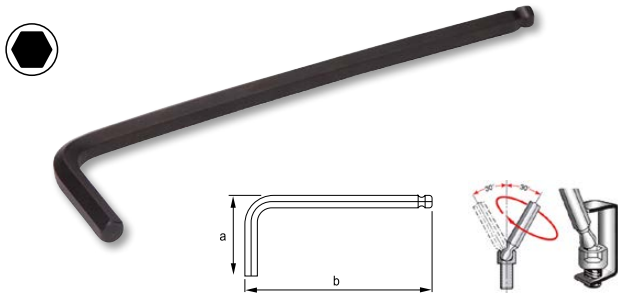

LLAVES TIPO ALLEN PAVONADAS, LARGAS, MÉTRICA CON BOLA

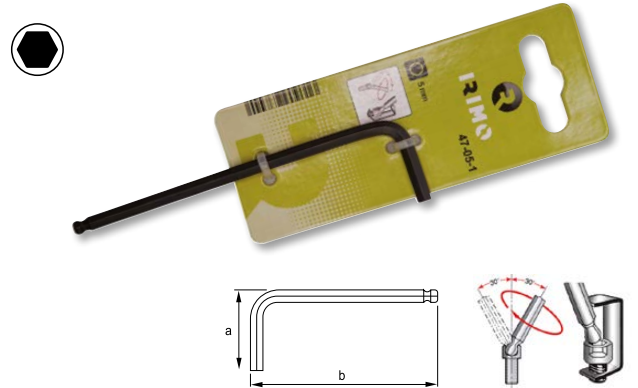

- Tamaño marcado en la varilla para fácil identificación
- La mayor longitud permite mejor accesibilidad y mayor par de transmisión
- Más eficiente dado que la bola permite introducir la cabeza en el tornillo desde diferentes ángulos
- ISO 2936

- Aleación de acero de alto rendimiento
- Pavonada
- Tamaño marcado en la varilla
- Brazo largo para fácil manejo
- Mayor eficiencia y ahorro de tiempo que con las llaves estándar
- ISO 2936

R			a mm	b mm	g	€
047001	10	1.5	15	91	1	1,19
047011	10	2.0	18	102	3	1,36
047021	10	2.5	21	114	5	1,42
047031	10	3.0	23	129	8	1,48
047041	10	4.0	29	144	17	1,76
047051	10	5.0	33	165	31	2,14
047061	10	6.0	38	186	50	3,27
047081	10	8.0	44	208	100	4,60
047101	5	10.0	50	234	171	8,26
047121	2	12.0	57	262	275	8,83

R			a mm	b mm	g	€
47-00-1	1	1.5	14.5	62.5	6.0	1,25
47-01-1	1	2.0	17.0	76.0	7.2	1,41
47-02-1	1	2.5	19.5	85.5	8.8	1,48
47-03-1	1	3.0	22.0	91.0	11.0	1,54
47-04-1	1	4.0	28.0	102.0	17.6	1,82
47-05-1	1	5.0	32.0	118.0	28.0	2,20
47-06-1	1	6.0	37.0	139.0	44.4	3,34
47-08-1	1	8.0	43.0	155.0	82.6	4,65
47-10-1	1	10.0	49.0	177.0	144.0	8,32

JUEGO LLAVES TIPO ALLEN LARGAS CON BOLA, MM

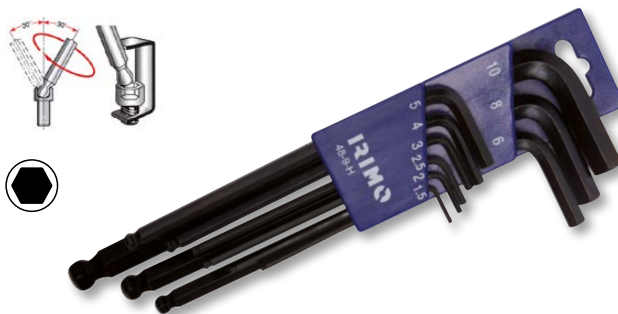

JUEGO LLAVES TIPO ALLEN LARGAS CON BOLA, PULGADAS



- Juego de 9 llaves tipo allen largas con bola, en mm
- Tamaños marcados en la tapa para su fácil identificación
- Embalaje en blíster

- Juego de 13 llaves tipo allen con bola largas, pulgadas
- Tamaños marcados en el plástico para su fácil identificación
- Embalaje en blíster

R				g	€
48-9-H	1	9	1.5, 2, 2.5, 3, 4, 5, 6, 8, 10 mm	360	15,26

R				g	€
48A-13-H	1	9	0.05-1/16-5/64-3/32-7/64-1/8-9/64-5/32-3/16-7/32-1/4-5/16-3/8"	360	16,00



LLAVES TIPO ALLEN PAVONADAS TORX®

LLAVES TIPO ALLEN PAVONADAS TORX®



- Pavonadas
- Tamaño marcado en la varilla para fácil identificación
- La mayor longitud permite mejor accesibilidad y mayor par de transmisión

Q	📦	♻️	a mm	b mm	g	€
457061	5	T-6	15	75	4	3,88
457071	5	T-7	16	80	4	3,93
457081	5	T-8	16	80	5	3,99
457091	5	T-9	16	80	5	4,04
457101	5	T-10	17	86	6	4,13
457151	5	T-15	18	90	10	4,23
457201	5	T-20	19	95	11	4,41
457251	5	T-25	20	100	17	4,45
457271	5	T-27	21	105	19	4,53
457301	5	T-30	24	114	29	4,58
457401	5	T-40	26	124	43	4,79
457451	5	T-45	29	133	61	5,01
457501	5	T-50	32	152	88	5,71

JUEGO LLAVES TIPO ALLEN TORX®



- Juego de 9 llaves tipo allen TORX® acabado en negro
- Tamaño marcado en la llave para una fácil identificación
- Agujero para colgar
- Embalaje en blíster

Q	📦	📦	🔧	♻️	g	€
458-9-H	10	9	T10, T15, T20, T25, T27, T30, T40, T45, T50		290	19,07

LLAVES TIPO ALLEN PAVONADAS TORX®

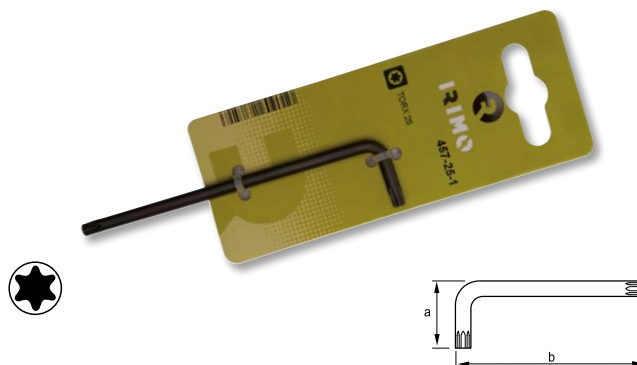

- Aleación de acero de alto rendimiento
- Pavonada
- Tamaño marcado en la varilla
- Brazo largo para fácil manejo

Q	📦	♻️	a mm	b mm	g	€
457-10-1	1	T10	17	86	10.0	4,41
457-15-1	1	T15	18	90	12.2	4,50
457-20-1	1	T20	19	95	15.2	4,67
457-25-1	1	T20	20	100	18.8	4,72
457-27-1	1	T27	21	105	23.2	4,81
457-30-1	1	T30	24	114	28.0	4,87
457-40-1	1	T40	26	124	48.2	5,08
457-45-1	1	T45	29	133	66.4	5,30
457-50-1	1	T50	32	152	94.2	6,04

JUEGO LLAVES TIPO ALLEN TORX®



- Juego en navaja de 8 llaves tipo allen TORX® acabado en negro
- Navaja bi-material resistente a impactos
- Permite trabajar en distintas posiciones
- Tope a 270°, máximo ángulo de giro
- Embalaje en blíster

Q	📦	📦	🔧	♻️	g	€
458-8-F	1	8	T9, T10, T15, T20, T25, T27, T30, T40		160	10,98





LLAVES TIPO ALLEN PAVONADAS PARA TORNILLOS TORX® INVIOABLES

LLAVES TIPO ALLEN PAVONADAS TORX® INVIOABLES

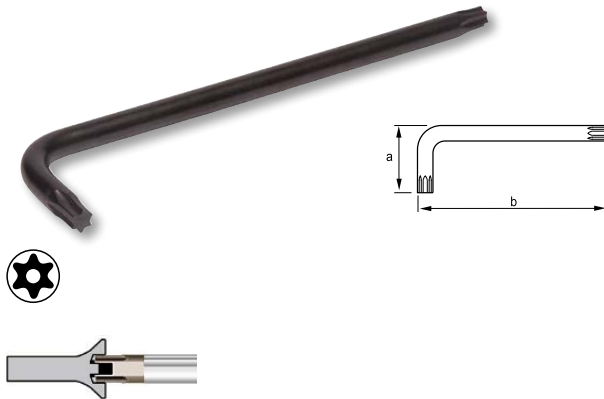

- Tamaño marcado en la varilla para fácil identificación
- La mayor longitud permite mejor accesibilidad y mayor par de transmisión

€			a mm	b mm	Ø mm	g	€
454091	5	TR9	16	80	3.0	4	4,89
454101	5	TR10	17	86	3.0	5	5,01
454151	5	TR15	18	90	4.0	8	5,14
454201	5	TR20	19	95	4.0	11	5,33
454251	5	TR25	20	100	5.0	17	5,39
454271	5	TR27	21	105	5.0	19	5,48
454301	5	TR30	24	114	6.0	29	5,56
454401	5	TR40	26	124	7.0	43	5,79

JUEGO LLAVES TIPO ALLEN PAVONADAS TORX® INVIOABLES, 9 piezas



- Juego de 9 llaves tipo allen pavonadas TORX® inviolables
- Medida marcada en la llave para una fácil identificación
- Agujero para colgar
- Embalaje en blíster

€				g	€
454-9-H	10	9	TR10, TR15, TR20, TR25, TR27, TR30, TR40, TR45, TR50	290	24,50

JUEGO LLAVES TIPO ALLEN PAVONADAS TORX® INVIOABLES



- Juego llaves tipo allen TORX® inviolable, 8 piezas
- Petaca bi-material resistente a impactos
- Permite trabajar en diferentes posiciones
- Tope a 270°, máximo ángulo de giro
- Embalaje en blíster

€				g	€
454-8-F	1	8	TR9, TR10, TR15, TR20, TR25, TR27, TR30, TR40	160	13,82



PUNTAS 1/4" PARA ATORNILLADOR

PUNTAS 1/4" PLANA, 25 MM



- Cuadrado: 1/4" DIN 3126-C 6,3, ISO 1173
- Caja de plástico de 10 uds.

E	Icono	mm	mm	L mm	g	€
475-4-1	1	0.5	4.0	25	35	6,77
475-4.5-1	1	0.6	4.5	25	35	6,77
475-5.5-1	1	0.8	5.5	25	35	6,77
475-6.0-1	1	1.0	6.0	25	35	6,89
475-6.5-1	1	1.2	6.5	25	35	7,28
475-8.0-1	1	1.6	8.0	25	35	10,62

PUNTAS 1/4" PLANA, 70 MM



- Cuadrado: 1/4" DIN 3126-C 6,3, ISO 1173
- Caja de plástico de 5 uds.

E	Icono	mm	mm	L mm	g	€
475-70-3.0-1	1	0.5	3.0	70	70	8,98
475-70-3.5-1	1	0.6	3.5	70	70	9,04
475-70-5.5-1	1	0.8	5.5	70	77	9,20
475-70-6.5-1	1	1.2	6.5	70	80	9,54

PUNTAS 1/4" PHILLIPS, 25 MM



- Cuadrado: 1/4" DIN 3126-C 6,3, ISO 1173
- Caja de plástico de 10 uds.

E	Icono	mm	g	€	
475-PH0-1	1	PH-0	25	35	3,88
475-PH1-1	1	PH-1	25	35	3,88
475-PH2-1	1	PH-2	25	35	3,88
475-PH3-1	1	PH-3	25	35	3,88

PUNTAS 1/4" PHILLIPS, 50 MM



- Cuadrado: 1/4" DIN 3126-E 6,3, ISO 1173
- Caja de plástico de 5 uds.

E	Icono	mm	g	€	
475-50PH1-1	1	PH-1	50	70	7,16
475-50PH2-1	1	PH-2	50	70	7,16
475-50PH3-1	1	PH-3	50	77	7,16

PUNTAS 1/4" PHILLIPS, 70 MM



- Cuadrado: 1/4" DIN 3126-E 6,3, ISO 1173
- Caja de plástico de 5 uds.

E	Icono	mm	g	€	
475-70PH1-1	1	PH-1	70	70	9,60
475-70PH2-1	1	PH-2	70	70	9,60
475-70PH3-1	1	PH-3	70	77	9,60





PUNTAS 1/4" PARA ATORNILLADOR

PUNTAS 1/4" PHILLIPS, 89 MM



x5

PUNTAS 1/4" PHILLIPS, 150 MM



x5

- Cuadrado: 1/4" DIN 3126-E 6,3, ISO 1173
- Caja de plástico de 5 uds.

R					g	€
475-89PH1-1	1	PH-1	89	100	11,12	
475-89PH2-1	1	PH-2	89	100	11,12	
475-89PH3-1	1	PH-3	89	110	11,12	

- Cuadrado: 1/4" DIN 3126-E 6,3, ISO 1173
- Caja de plástico de 5 uds.

R					g	€
475-150PH1-1	1	PH-1	150	150	13,94	
475-150PH2-1	1	PH-2	150	150	13,94	

PUNTAS 1/4" PHILLIPS, 25 MM



x10

PUNTAS 1/4" POZIDRIV, 25 MM



x10

- Específicos para utilizar en trabajos con yeso
- Diámetro reducido Ø 4,8 mm
- Cuadrado: 1/4" DIN 3126-C 6,3, ISO 1173
- Caja de plástico de 10 uds.

R					g	€
475-PH2G-1	1	PH-2G	25	35	3,88	

- Cuadrado: 1/4" DIN 3126-C 6,3, ISO 1173
- Caja de plástico de 10 uds.

R					g	€
475-PZ0-1	1	PZ-0	25	35	3,88	
475-PZ1-1	1	PZ-1	25	35	3,88	
475-PZ2-1	1	PZ-2	25	35	3,88	
475-PZ3-1	1	PZ-3	25	35	3,88	

PUNTAS 1/4" POZIDRIV, 50 MM



x5

- Cuadrado: 1/4" DIN 3126-C 6,3, ISO 1173
- Caja de plástico de 5 uds.

R					g	€
475-50PZ1-1	1	PZ-1	50	70	7,16	
475-50PZ2-1	1	PZ-2	50	70	7,16	
475-50PZ3-1	1	PZ-3	50	77	7,16	



PUNTAS 1/4" POZIDRIV, 70 MM



x5



- Cuadrado: 1/4" DIN 3126-E 6,3, ISO 1173
- Caja de plástico de 5 uds.

R			L mm	g	€
475-70PZ1-1	1	PZ-1	70	70	9,60
475-70PZ2-1	1	PZ-2	70	70	9,60
475-70PZ3-1	1	PZ-3	70	77	9,60

PUNTAS 1/4" POZIDRIV, 89 MM



x5



- Cuadrado: 1/4" DIN 3126-E 6,3, ISO 1173
- Caja de plástico de 5 uds.

R			L mm	g	€
475-89PZ1-1	1	PZ-1	89	100	11,12
475-89PZ2-1	1	PZ-2	89	100	11,12
475-89PZ3-1	1	PZ-3	89	110	11,12

PUNTAS 1/4" TORX®, 25 MM



x10



- Cuadrado: 1/4" DIN 3126-C 6,3, ISO 1173
- Caja de plástico de 10 uds. (T30/T40 en caja de 5 uds.)

R			L mm	g	€	
475-T5-1	1	T5	1.70	25	30	5,82
475-T6-1	1	T6	1.70	25	30	5,82
475-T7-1	1	T7	1.99	25	35	5,82
475-T8-1	1	T8	2.31	25	35	5,82
475-T9-1	1	T9	2.50	25	35	5,82
475-T10-1	1	T10	2.74	25	35	5,95
475-T15-1	1	T15	3.27	25	35	5,95
475-T20-1	1	T20	3.86	25	35	5,95
475-T25-1	1	T25	4.43	25	35	5,95
475-T27-1	1	T27	4.99	25	35	5,95
475-T30-1	1	x5 T30	5.52	25	40	3,13
475-T40-1	1	x5 T40	6.65	25	50	3,13
475-T45-1	1	T45	7.90	25	70	6,61
475-T50-1	1	T50	7.94	25	80	6,61

PUNTAS 1/4" POZIDRIV, 150 MM



x5



- Cuadrado: 1/4" DIN 3126-E 6,3, ISO 1173
- Caja de plástico de 5 uds.

R			L mm	g	€
475-150PZ1-1	1	PZ-1	150	150	13,94
475-150PZ2-1	1	PZ-2	150	150	13,94

PUNTAS 1/4" TORX®, 50 MM



x5



- Cuadrado: 1/4" DIN 3126-C 6,3, ISO 1173
- Caja de plástico de 5 uds.

R			L mm	g	€	
475-50T6-1	1	T6	1.70	50	38	7,34
475-50T8-1	1	T8	2.51	50	40	7,34
475-50T10-1	1	T10	2.74	50	42	7,34
475-50T15-1	1	T15	3.27	50	44	7,51
475-50T20-1	1	T20	3.86	50	46	7,51
475-50T25-1	1	T25	4.43	50	50	7,57
475-50T30-1	1	T30	5.52	50	52	7,57
475-50T40-1	1	T40	6.65	50	54	7,57





PUNTAS 1/4" PARA ATORNILLADOR

PUNTAS 1/4" TORX®, 89 MM



x5

PUNTAS 1/4" TORX®, 150 MM



x5

- Cuadrado: 1/4" DIN 3126-C 6,3, ISO 1173
- Caja de plástico de 5 uds.

R							€
475-89T10-1	1	T10	2.74	89	80	8,47	
475-89T15-1	1	T15	3.27	89	85	8,47	
475-89T20-1	1	T20	3.86	89	90	8,47	
475-89T25-1	1	T25	4.43	89	100	8,47	
475-89T27-1	1	T27	4.99	89	100	8,47	
475-89T30-1	1	T30	5.52	89	110	8,47	
475-89T40-1	1	T40	6.65	89	120	8,47	

- Cuadrado: 1/4" DIN 3126-C 6,3, ISO 1173
- Caja de plástico de 5 uds.

R							€
475-150T10-1	1	T10	2.74	150	150	11,01	
475-150T15-1	1	T15	3.27	150	150	11,01	
475-150T20-1	1	T20	3.86	150	153	11,01	
475-150T25-1	1	T25	4.43	150	155	11,01	
475-150T30-1	1	T30	5.52	150	157	11,01	
475-150T40-1	1	T40	6.65	150	160	11,01	

PUNTAS 1/4" TORX® INVOLABLES, 25 MM



x5

PUNTAS 1/4" HEXAGONALES, 25 MM



x5

- Cuadrado: 1/4" DIN 3126-C 6,3, ISO 1173
- Caja de plástico de 5 uds.

R							€
475-TR10-1	1	T10	2.74	25	35	6,86	
475-TR15-1	1	T15	3.27	25	35	6,86	
475-TR20-1	1	T20	3.86	25	35	6,86	
475-TR25-1	1	T25	4.43	25	35	6,86	
475-TR27-1	1	T27	4.99	25	35	6,86	
475-TR30-1	1	T30	5.52	25	40	6,86	
475-TR40-1	1	T40	6.65	25	50	6,86	

- Cuadrado: 1/4" DIN 3126-C 6,3, ISO 1173
- Caja de plástico de 5 uds.

R							€
475-H3-1	1	3		25	30	6,94	
475-H4-1	1	4		25	35	6,94	
475-H5-1	1	5		25	40	6,94	
475-H6-1	1	6		25	45	6,94	



PUNTA TORSIÓN PHILLIPS, 25 MM



x10



- Cuadrado: 1/4" DIN 3126-C 6,3, ISO 1173
- Acabado: Superficie de acero gris lacado transparente para mayor protección
- Material: aleación de acero de alto rendimiento
- Aplicación: puntas de torsión para materiales duros
- Zona de torsión que absorbe los picos de esfuerzo evitando desgastes y desgarros prematuros y aumentando la duración del producto
- Caja de plástico de 10 uds.

IRIMO			L mm	g	€
475T-PH1-1	1	PH-1	25	30	9,65
475T-PH2-2	1	PH-2	25	40	9,65
475T-PH3-2	1	PH-3	25	40	9,65

PUNTA TORSIÓN POZIDRIV, 25 MM



x10



- Cuadrado: 1/4" DIN 3126-C 6,3, ISO 1173
- Acabado: Superficie de acero gris lacado transparente para mayor protección
- Material: aleación de acero de alto rendimiento
- Aplicación: puntas de torsión para materiales duros
- Zona de torsión que absorbe los picos de esfuerzo evitando desgastes y desgarros prematuros y aumentando la duración del producto
- Caja de plástico de 10 uds.

IRIMO			L mm	g	€
475T-PZ1-1	1	PZ-1	25	30	9,65
475T-PZ2-2	1	PZ-2	25	40	9,65
475T-PZ3-2	1	PZ-3	25	40	9,65

PUNTA DE DIAMANTE PHILLIPS, 25 MM



x5



- Cuadrado: 1/4" DIN 3126-C 6,3, ISO 1173
- Acabado: cubierta de diamante de color dorado
- Material: aleación de acero de alto rendimiento
- Aplicación: gran rendimiento en cualquier aplicación
- Minimiza el efecto expulsión reduciendo el tiempo perdido
- Reduce desgaste de la punta y tornillo
- Zona de torsión que absorbe los picos de esfuerzo evitando desgastes y desgarros prematuros y aumentando la duración del producto
- Caja de plástico de 5 uds.

IRIMO			L mm	g	€
475D-PH1-1	1	PH-1	25	30	9,65
475D-PH2-1	1	PH-2	25	40	9,65
475D-PH3-1	1	PH-3	25	40	9,65

PUNTA DE DIAMANTE POZIDRIV, 25 MM



x5



- Cuadrado: 1/4" DIN 3126-C 6,3, ISO 1173
- Acabado: cubierta de diamante de color dorado
- Material: aleación de acero de alto rendimiento
- Aplicación: gran rendimiento en cualquier aplicación
- Minimiza el efecto expulsión reduciendo el tiempo perdido
- Reduce desgaste de la punta y tornillo
- Zona de torsión que absorbe los picos de esfuerzo evitando desgastes y desgarros prematuros y aumentando la duración del producto
- Caja de plástico de 5 uds.

IRIMO			L mm	g	€
475D-PZ1-1	1	PZ-1	25	30	9,65
475D-PZ2-1	1	PZ-2	25	40	9,65
475D-PZ3-1	1	PZ-3	25	40	9,65





PUNTAS 1/4" PARA ATORNILLADOR

PUNTA STECKER MAGNÉTICA



- Cuadrado: 1/4" DIN 3126 E 6.3 ISO 1173
- Vaso hexagonal con un fuerte imán
- Para uso general en industria
- Envase unitario para colgar

R		mm	mm	mm	mm	g	€
474M-5.5-1	1	5.5	1/4"	11.5	50	25	5,48
474M-6-1	1	6	1/4"	11	50	21	5,30
474M-7-1	1	7	1/4"	12	50	28	5,30
474M-8-1	1	8	1/4"	12.5	50	24	5,30
474M-9-1	1	9	1/4"	13.5	50	31	5,42
474M-10-1	1	10	1/4"	15.5	50	36	5,48
474M-11-1	1	11	1/4"	18.4	50	30	5,48
474M-12-1	1	12	1/4"	14.5	50	34	5,48
474M-13-1	1	13	1/4"	17	50	40	5,48

JUEGO DE 5 PUNTAS STECKER MAGNÉTICAS



- Juego de 5 puntas stecker magnéticas
- Cuadradillo 1/4" DIN 3126 E 6.3 ISO 1173
- Acero aleado de alto rendimiento
- Con imán fuerte
- Vaso hexagonal
- Embalaje en blíster

R		x	g	€
474M-5-H	1	5	134	23,14

474M-5.5-1, 474M-7-1, 474M-8-1, 474M-10-1, 474M-13-1

PUNTA STECKER MAGNÉTICA, PULGADAS



- Cuadrado: 1/4" DIN 3126 E 6.3 ISO 1173
- Vaso hexagonal con un fuerte imán
- Para uso general en industria
- Envase unitario para colgar

R		mm	mm	mm	mm	g	€
474M-1/4-1	1	1/4"	1/4"	11	50	21	5,99
474M-3/8-1	1	3/8"	1/4"	14.3	50	31	5,48

PUNTA STECKER 1/4" CON ANILLA DE RETENCIÓN



- Cuadrado: 1/4" DIN 3126-E 6,3, ISO 1173
- Acabado mate antideslizamiento
- Material: aleación de acero de alto rendimiento
- Para uso general en industria
- Vaso hexagonal
- Envase unitario para colgar

R		mm	mm	mm	mm	g	€
474MR-8-1	1	8	1/4"	12.5	50	24	5,48
474MR-10-1	1	10	1/4"	13.5	50	36	5,59



ADAPTADOR CUADRADO 1/4"



- Cuadrado: 1/4" DIN 3126-A6,3, ISO 1173
- Hexágono macho a cuadrado macho
- DIN 3120
- En bolsa unitaria

R						€
475A-25-1	1	1/4"	1/4"	25	5	1,73

ADAPTADOR PARA MÁQUINA 1/4"



- Cuadrado: 1/4" DIN 3126-A6,3, ISO 1173
- Hexágono macho a cuadrado macho
- DIN 3120
- Envase unitario para colgar

R						€
475A-50-1	1	1/4"	1/4"	50	18	5,41
475A-50-1/2-1	1	1/2"	1/4"	50	25	7,52

ADAPTADOR MAGNÉTICO UNIVERSAL, 1/4"



- Cuadrado: 1/4" DIN 3126-E 6,3, ISO 1173
- Fuerte imán
- DIN 3126 D 6,3
- Envase unitario para colgar

R						€
475A-M-50-1	1	1/4"	1/4"	50	20	7,06
475A-M-75-1		1/4"	1/4"	75	35	7,46
475A-M-150-1	1	1/4"	1/4"	150	47	10,44

PORTAPUNTAS 1/4" CON SISTEMA DE AJUSTE RÁPIDO



- DIN 3126-E6.3, ISO 1173
- DIN 3126 D 6,3
- Imán permanente
- Envase unitario para colgar

R							€
475A-60QR-1	1	1/4"	1/4"	14	60	15	11,01
475A-75QR-1	1	1/4"	1/4"	14	75	33	11,58





JUEGOS DE PUNTAS 1/4"

JUEGO, 32 piezas



- DIN 3126-C 6,3, ISO 1173
- En blíster
- Display 8 juegos: 475-32-8 Disp

R	📦	📦 x	📏 mm	📖 g	€
475-32-1	1	32	30x105x65	275	12,58
475-32-8DISP	1	8	360x340x260	2.240	100,65
475-4.5-1, 475-4-1, 475-5.5-1					⓪
2x 475-PH1-1, 2x 475-PH2-1, 2x 475-PH3-1					⊕
475-PH2G-1					⊕
2x 475-PZ1-1, 2x 475-PZ2-1, 2x 475-PZ3-1					⊗
475-T10-1, 2x 475-T15-1, 2x 475-T20-1, 2x 475-T25-1, 475-T27-1, 2x 475-T30-1, 475-T40-1					⊛
475-H3-1, 475-H4-1, 475-H5-1, 475-H6-1					●
475A-25-1					⓪
105-48-1					⓪
475A-60QR-1					⓪

JUEGO, 32 piezas



- Juego de puntas de 32 piezas: 30 puntas, 1 portapuntas magnético de liberación rápida y 1 destornillador portapuntas para brocas intercambiables
- DIN 3126, ISO 1173, estilo C 6.3
- Sistema para bloqueo fácil y seguro, magnético. La punta permanece sujeta hasta que se indica su liberación
- Puntas de gran dureza, de acabado granallado
- Portapuntas de liberación rápida con fuerte imán (estilo E 6.3)
- Robusta caja de plástico con asa. Tapa transparente
- Para uso universal
- Aleación de acero de alto rendimiento
- En blíster

R	📦	📦 x	📏 mm	📖 g	€
475-32A-1	6	32	153x35x100	375	27,44
475A-60QR-1					⓪
475-4.5-1, 475-5.5-1, 475-6.5-1					⓪
3x 475-PH1-1, 3x 475-PH2-1, 3x 475-PH3-1					⊕
3x 475-PZ1-1, 3x 475-PZ2-1, 3x 475-PZ3-1					⊗
475-H4-1, 475-H5-1, 475-H6-1					●
475-T10-1, 475-T15-1, 475-T20-1, 475-T25-1, 475-T30-1, 475-T40-1					⊛





JUEGO DE PUNTAS 1/4" TORX®



- Juego de 8 puntas TORX® y 1 portapuntas magnético de liberación rápida
- Hexágono 1/4". DIN 3126, ISO 1173, tipo C 6.3
- Puntas robustas
- Portapuntas magnético de liberación rápida (tipo E 6.3)
- El tamaño del juego es ideal para llevar en un bolsillo. Fácil de abrir y cerrar
- Para uso universal
- Aleación de acero de alto rendimiento
- Embalaje en blister

IRIMO	Paquete	Blister	mm	g	€
475-9-1	1	9	40x20x97	129	7,84
475A-60QR-1					
475-T10-1, 475-T15-1, 2x 475-T20-1, 2x 475-T25-1, 475-T30-1, 475-T40-1					

JUEGO, 61 piezas



- DIN 3126-C 6,3, ISO 1173
- Envasado en blister

IRIMO	Paquete	Blister	mm	g	€
475-61-1	1	61	35 x 148 x 112	549	22,33
475-4.5-1, 475-4-1, 475-5.5-1, 475-6.0-1, 475-6.5-1, 475-8.0-1					
475-PH0-1, 2x 475-PH1-1, 3x 475-PH2-1, 2x 475-PH3-1					
2x 475-PH2G-1					
475-PZ0-1, 2x 475-PZ1-1, 3x 475-PZ2-1, 2x 475-PZ3-1					
475-T6-1, 475-T7-1, 475-T8-1, 475-T9-1, 2x 475-T10-1, 2x 475-T15-1, 3x 475-T20-1, 2x 475-T25-1, 2x 475-T27-1, 2x 475-T30-1, 2x 475-T40-1					
475-TR10-1, 475-TR15-1, 475-TR20-1, 475-TR25-1, 475-TR27-1, 475-TR30-1, 475-TR40-1					
475-H3-1, 475-H4-1, 475-H5-1, 475-H6-1					
475A-25-1					
R-1, R-2, R-3					
475A-60QR-1					

SET DESTORNILLADOR DE PRECISIÓN PARA APLICACIONES DE INGENIERÍA Y ELECTRÓNICA

DESTORNILLADOR DE PRECISIÓN CON PORTAPUNTAS A CARRACA, 17 piezas

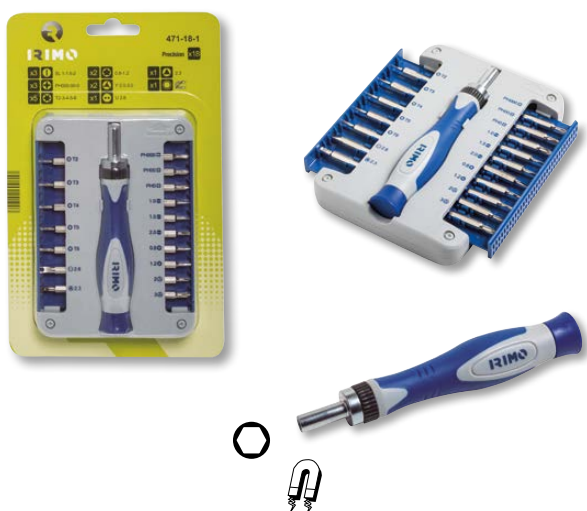

- Cuadradillo: 5/32" DIN 3126-C 4, ISO 1173
- Puntas de acero de cromo vanadio, gran duración y precisión
- Mango bi-material
- Cabeza giratoria para mayor facilidad y precisión
- Imán en la cabeza que permite asegurar la punta en el destornillador
- Suave movimiento de carraca: mecanismo de tres posiciones:
- Delantera, trasera y neutral
- Embalaje en blister

IRIMO	Paquete	Blister	mm	g	€
471-18-1	1	17	35 x 95 x 130	220	18,58
x3	⓪	SL: 1-1.5-2 mm	x3	⊕	PH000-PH00-PH0
x5	⊕	T2-T3-T4-T5-T6	x2	⊕	0.8-1.2
x2	⊕	Y 2.0-3.0	x1	⊕	U 2.6
x1	⊕	2.3	x1	⊕	



PUNTAS 5/16"

PUNTAS 5/16" RANURADAS



x2

- DIN 3126-C 8, ISO 1173
- Acabado: Zinc fosfatado
- En bolsas de 2 uds.

€						€
470-5.5-1	1	1.0	5.5	36	18	5,57
470-6.5-1	1	1.2	6.5	36	20	5,69
470-8.0-1	1	1.2	8.0	36	22	6,05
470-10.0-1	1	1.6	10.0	36	30	8,00
470-12.0-1	1	2.0	12.0	36	36	8,20
470-14.0-1	1	2.5	14.0	36	38	10,93

PUNTAS 5/16" PHILLIPS



x2

- DIN 3126-C 8, ISO 1173
- Acabado: Zinc fosfatado
- En bolsas de 2 uds.

€					€
470-PH1-1	1	PH-1	36	22	3,79
470-PH2-1	1	PH-2	36	24	3,79
470-PH3-1	1	PH-3	36	25	3,79
470-PH4-1	1	PH-4	36	28	4,75

PUNTAS 5/16" HEXAGONALES



x2

- DIN 3126-C 8, ISO 1173
- Acabado: Zinc fosfatado
- En bolsas de 2 uds.

€					€
470-H4-1	1	4	36	25	4,54
470-H5-1	1	5	36	26	4,54
470-H6-1	1	6	36	27	4,54
470-H7-1	1	7	36	28	4,54
470-H8-1	1	8	36	29	4,54
470-H10-1	1	10	36	36	6,56

PUNTAS 5/16" TORX®



x2

- DIN 3126-C 8, ISO 1173
- Acabado: Zinc fosfatado
- En bolsas de 2 uds.

€						€
470-T20-1	1	T20	3.86	36	21	4,88
470-T25-1	1	T25	4.43	36	22	4,88
470-T27-1	1	T27	4.99	36	24	4,88
470-T30-1	1	T30	5.52	36	24	4,88
470-T40-1	1	T40	6.65	36	27	4,88
470-T45-1	1	T45	7.82	36	27	4,88
470-T50-1	1	T50	8.83	36	27	5,69
470-T55-1	1	T55	11.22	36	28	6,59



DESTORNILLADOR A GOLPE 5/16"

DESTORGOLPE



- Para girar tornillos atorados
- Cuadrado de 1/2", puntas 5/16"
- Reversible colocando adaptador

€		L mm	C mm	A mm	L1 mm	g	€
470011	1	125	33	24	40	650	28,54

ADAPTADOR



- Acabado: cromado plateado
- Cuadrado 1/2"
- Para puntas 5/16"
- Con anilla de retención

€		L mm	g	€
470051	1	40	54	6,62

JUEGO DE DESTORNILLADOR A GOLPE



- Destornillador de impacto 1/2"
- Adaptador portapuntas hexágono 5/16" y cuadrado 1/2"
- 18 puntas 5/16"
- En caja metálica

€			g	€
471011	1	197 x 70 x 45	1.280	58,71
470-8.0-1, 470-10.0-1, 470-12.0-1				
470-PH2-1, 470-PH3-1, 470-PH4-1				
470-H4-1, 470-H5-1, 470-H6-1, 470-H7-1, 470-H8-1, 470-H10-1				
470-T25-1, 470-T27-1, 470-T30-1, 470-T40-1, 470-T45-1, 470-T50-1				
470011				



PUNTAS 10 MM

PUNTA HEXAGONAL



- Acabado zinc fosfatado
- Envase individual

Artículo	Paquete	mm	L mm	g	€
T49H4	1	4	30	5	2,67
T49H5	1	5	30	6.5	2,67
T49H6	1	6	30	7	2,67
T49H7	1	7	30	7	2,67
T49H8	1	8	30	7	2,67
T49H10	1	10	30	7	2,67
T49H12	1	12	30	12	3,16
T49H14	1	14	30	14	4,98
T49H4L	1	4	75	20	3,97
T49H5L	1	5	75	20	3,97
T49H6L	1	6	75	20	3,97
T49H7L	1	7	75	20	3,97
T49H8L	1	8	75	20	3,97
T49H10L	1	10	75	20	3,97
T49H12L	1	12	75	20	4,98
T49H10XL	1	10	115	75	6,68

PUNTA TORX®



- Acabado zinc fosfatado
- Envase individual

Artículo	Paquete	Tamaño	mm	L mm	g	€
T49T20	1	T20	3.84	30	6.5	2,55
T49T25	1	T25	4.4	30	6.5	2,55
T49T27	1	T27	4.96	30	6.5	2,55
T49T30	1	T30	5.49	30	6.5	2,55
T49T40	1	T40	6.6	30	6.5	2,55
T49T45	1	T45	7.7	30	6.5	2,55
T49T50	1	T50	8.79	30	6.5	2,55
T49T55	1	T55	11.17	30	6.5	2,55
T49T60	1	T60	13.2	30	6.5	3,95
T49T20L	1	T20	3.84	75	20	3,76
T49T25L	1	T25	4.4	75	20	3,76
T49T27L	1	T27	4.96	75	20	3,76
T49T30L	1	T30	5.49	75	20	3,76
T49T40L	1	T40	6.6	75	20	3,76
T49T45L	1	T45	7.7	75	20	3,76
T49T50L	1	T50	8.79	75	20	3,76
T49T55L	1	T55	11.17	75	20	3,76
T49T60L	1	T60	13.2	75	20	5,16
T49T55XL	1	T55	11.17	115	75	6,95

ADAPTADOR DE 1/2" PARA PUNTAS



- Adaptador de 1/2" para puntas 10 mm
- Acabado zinc fosfatado
- Envase individual

Artículo	Paquete	mm	L mm	D1 mm	D2 mm	g	€
T4901	1	10	36	17	22	55	6,95

ADAPTADOR DE 3/8" PARA PUNTAS



- Adaptador de 3/8" para puntas 10 mm
- Acabado zinc fosfatado
- Envase individual

Artículo	Paquete	mm	L mm	D1 mm	D2 mm	g	€
T4902	1	10	35	15	10	32	5,96



PUNTA TORX® INVIOLEBLE



- Acabado zinc fosfatado
- Envase individual

R				L mm	g	€
T49T20H	1	TR20	3.84	30	6.5	2,67
T49T25H	1	TR25	4.4	30	6.5	2,67
T49T27H	1	TR27	4.96	30	6.5	2,67
T49T30H	1	TR30	5.49	30	6.5	2,67
T49T40H	1	TR40	6.6	30	6.5	2,67
T49T45H	1	TR45	7.7	30	6.5	2,67
T49T50H	1	TR50	8.79	30	6.5	2,67
T49T55H	1	TR55	11.17	30	6.5	2,67
T49T60H	1	TR60	13.2	30	6.5	4,15
T49T20HL	1	TR20	3.84	75	20	3,97
T49T25HL	1	TR25	4.4	75	20	3,97
T49T27HL	1	TR27	4.96	75	20	3,97
T49T30HL	1	TR30	5.49	75	20	3,97
T49T40HL	1	TR40	6.6	75	20	3,97
T49T45HL	1	TR45	7.7	75	20	3,97
T49T50HL	1	TR50	8.79	75	20	3,97
T49T55HL	1	TR55	11.17	75	20	3,97
T49T60HL	1	TR60	13.2	75	20	5,45

PUNTA CUADRADA



- Acabado zinc fosfatado
- Envase individual

R			L mm	g	€
T49SQ8	1	8	30	17	3,91
T49SQ10	1	10	30	22	4,68

PUNTA XZN



- Acabado zinc fosfatado
- Envase individual

R			L mm	g	€
T49M5	1	M5	30	6.5	2,67
T49M6	1	M6	30	7	2,67
T49M8	1	M8	30	7	2,67
T49M10	1	M10	30	8.5	2,67
T49M12	1	M12	30	10	3,16
T49M14	1	M14	30	20	4,20
T49M5L	1	M5	75	15	3,97
T49M6L	1	M6	75	15	3,97
T49M8L	1	M8	75	15	3,97
T49M10L	1	M10	75	15	3,97
T49M12L	1	M12	75	15	4,98



VASOS CON PUNTA 1/2"

VASOS 1/2" CON PUNTA TORX® INVIOLEBLE



- Vasos con punta 1/2" TORX® inviolable
- Acabado zinc fosfatado
- Envase individual

€				L mm	L1 mm	g	€
T49T30XL	1	TR30	1/2"	200	160	122	10,06
T49T40XL	1	TR40	1/2"	200	160	123	10,06
T49T45XL	1	TR45	1/2"	200	160	125	10,06
T49T70HL	1	TR70	1/2"	100	60	167	18,01
T49T80HL	1	TR80	1/2"	100	30	163	18,01

JUEGO, 31 piezas



- Acabado zinc fosfatado
- Caja metálica

€		X		g	€
471151	1	31	37 x 195 x 105	1.270	77,48
T4901					
T49H5, T49H6, T49H6L, T49H8, T49H8L, T49H10, T49H10XL, T49H12, T49H14					
T49M5, T49M6, T49M8, T49M8L, T49M10, T49M10L, T49M12, T49M12L, T49M14					
T49T20, T49T25, T49T27, T49T30, T49T40, T49T45, T49T45L, T49T50, T49T55, T49T55XL					
T49SQ8, T49SQ10					

JUEGO, 49 piezas



- Acabado zinc fosfatado
- Caja metálica

€		X		g	€
T49	1	49	60 x 325 x 195	3.600	100,69
T4901					
T4902					
T49T30XL, T49T40XL, T49T45XL, T49T70HL, T49T80HL					
T49H4, T49H4L, T49H5, T49H5L, T49H6, T49H6L, T49H7, T49H7L, T49H8, T49H8L, T49H10, T49H10L, T49H12, T49H12L					
T49M5, T49M5L, T49M6, T49M6L, T49M8, T49M8L, 49M10, T49M10L, T49M12, T49M12L					
T49T20H, T49T20HL, T49T25H, T49T25HL, T49T27H, T49T27HL, T49T30H, T49T30HL, T49T40H, T49T40HL, T49T45H, T49T45HL, T49T50H, T49T50HL, T49T55H, T49T55HL, T49T60H, T49T60HL					



08. HERRAMIENTAS DE GOLPEO



GOLPEO

CORTAFRIOS



- Cromo vanadio
- UNE 16567

R		L mm	S mm	A mm	g	€
501-150-1	25	150	18	10	133	8,79
501-175-1	25	175	21	11	192	9,66
501-200-1	25	200	22	12	243	11,73
501-250-1	20	250	25	13	357	15,06
501-300-1	25	300	26	14	552	20,51

CORTAFRIOS PLANO

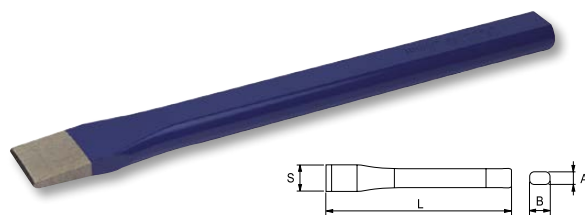

- Cromo molibdeno vanadio
- Acabado: Lacado, pintado en azul
- Plano con laterales ovalados
- DIN 7250

R		L mm	S mm	AxB mm	g	€
504-150-1	10	150	21	11x17	181	8,51
504-175-1	10	175	24	12x20	269	11,28
504-200-1	10	200	28	13x23	390	11,86
504-250-1	10	250	28	13x23	500	14,09
504-300-1	10	300	32	13x26	602	16,08

CORTAFRIOS PLANO

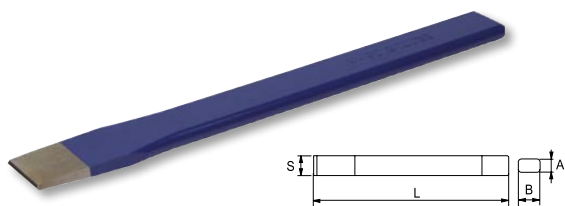

- Cromo molibdeno vanadio
- Acabado: Lacado, pintado en azul
- Plano con laterales ovalados

R		L mm	S mm	A mm	B mm	g	€
502-230-1	10	230	26	7	26	285	12,54

CORTAFRIOS EXTRAPLANO

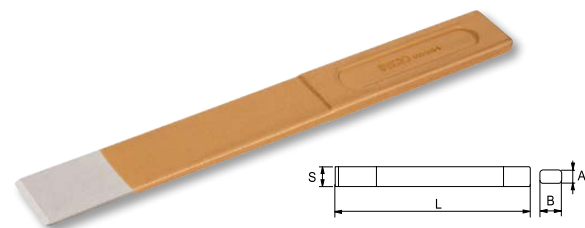

- Cortafrios extraplano
- Cromo molibdeno vanadio
- Plano con laterales ovalados

R		L mm	S mm	A mm	B mm	g	€
500-240-1	10	230	26	4	26	278	14,58

BURIL NERVADO

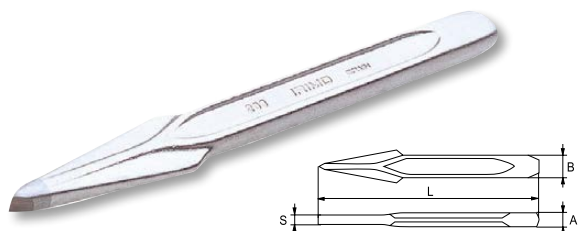

- Cromo vanadio
- UNE 16568

R		L mm	S mm	AxB mm	g	€
505-150-1	5	150	6.5	11x17	129	7,45
505-200-1	5	200	8.5	12x21	241	10,24
505-250-1	5	250	9.5	14x24	404	15,10

BURIL PLANO

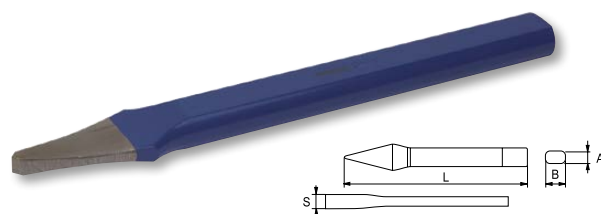

- Cromo molibdeno vanadio
- Acabado: Lacado, pintado en azul
- Plano con laterales ovalados
- DIN 7250

R		L mm	S mm	AxB mm	g	€
506-150-1	10	150	6	11x17	152	8,61
506-175-1	10	175	7	12x20	231	11,01
506-200-1	10	200	8	13x23	335	11,68



GRANETE REDONDO

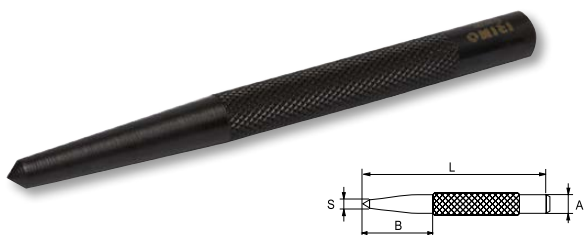

- Acabado: Pavonado
- UNE 16574

E		S mm	L mm	A mm	B mm	g	€
511-100-1	25	2.5	100	8	35	31	3,37
511-105-1	25	4	105	8	35	34	3,37
511-110-1	25	5	110	8	40	37	3,37
511-115-1	25	6	115	10	45	60	3,78
511-130-1	20	8	130	12	50	98	4,48

GRANETE OCTOGONAL

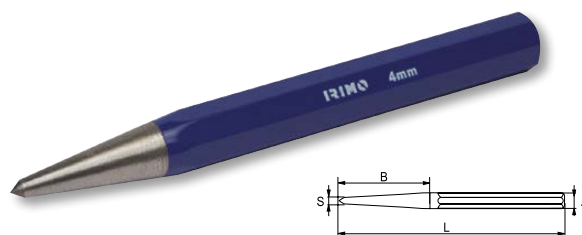

- Cromo molibdeno vanadio
- Acabado: Lacado, pintado en azul
- Perfil octogonal
- DIN 7250

E		S mm	L mm	A mm	B mm	g	€
512-010-1	25	4	120	10	40	62	3,37
512-012-1	25	5	120	12	40	88	4,18

JUEGOS DE GRANETES REDONDOS



E				g	€
511-91-4	1	4	2.5 - 4 - 6 - 8 mm	234	14,99
511-92-4	1	5	2.5 - 4 - 5 - 6 - 8 mm	275	18,42

BOTADOR CÓNICO REDONDO

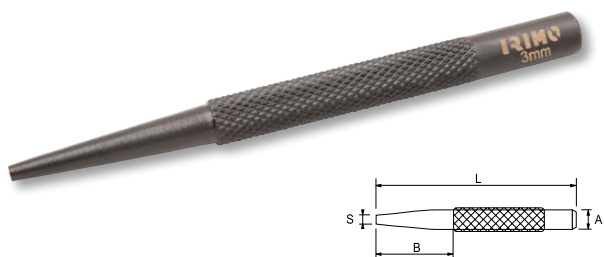

- Acabado: Pavonado
- UNE 16576

E		S mm	L mm	A mm	B mm	g	€
513-002-1	25	2	100	8	35	31	3,18
513-003-1	25	3	100	8	35	32	3,18
513-004-1	25	4	115	10	45	55	3,37
513-005-1	25	5	115	10	45	59	3,37
513-006-1	20	6	130	12	50	94	4,02
513-008-1	20	8	150	12	55	117	4,38
513-010-1	20	10	170	14	60	183	5,87

BOTADOR CÓNICO OCTOGONAL

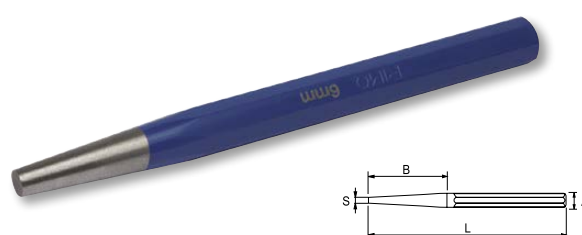

- Cromo molibdeno vanadio
- Acabado: Lacado, pintado en azul
- Perfil octogonal
- DIN 6458

E		S mm	L mm	A mm	B mm	g	€
514-002-1	25	2	120	10	40	60	3,20
514-003-1	25	3	120	10	40	60	3,20
514-004-1	25	4	120	10	40	62	3,40
514-005-1	25	5	120	10	40	64	3,40
514-006-1	25	6	120	12	40	93	4,06





GOLPEO

JUEGO DE BOTADORES CÓNICOS



IRIMO	Paquete	Caja	Diagrama	g	€
513-91-4	1	5	2-4-6-8-10 mm	502	20,83
513-92-4	1	7	2-3-4-5-6-8-10 mm	602	27,37

JUEGO DE BOTADORES CÓNICOS, PERFIL OCTOGONAL



IRIMO	Paquete	Caja	Diagrama	g	€
519-91-4	1	6	150x80x12	409	19,60

2-3-4-5-6 mm

4 mm

BOTADOR CILÍNDRICO REDONDO

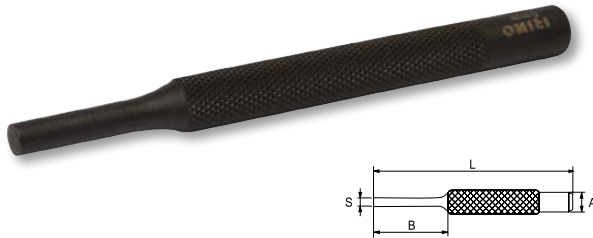

- Acabado: Pavonado
- UNE 16575

IRIMO	Paquete	S mm	L mm	A mm	B mm	g	€
515-002-1	25	2	100	8	28	29	3,67
515-003-1	25	3	100	8	28	30	3,67
515-004-1	25	4	100	8	28	31	3,67
515-005-1	25	5	115	10	33	53	3,78
515-006-1	25	6	115	10	33	55	3,78
515-007-1	25	7	115	10	33	58	3,78
515-008-1	20	8	130	12	43	91	4,57
515-009-1	20	9	130	12	43	96	4,57
515-010-1	20	10	130	14	53	143	5,71

BOTADOR CILÍNDRICO OCTOGONAL



- Cromo molibdeno vanadio
- Acabado: Lacado, pintado en azul
- Perfil octogonal
- DIN 6450

IRIMO	Paquete	S mm	L mm	A mm	B mm	g	€
516-002-1	20	2	150	10	35	63	5,15
516-003-1	20	3	150	10	40	63	5,15
516-004-1	20	4	150	10	50	63	5,15
516-005-1	20	5	150	10	50	64	5,15
516-006-1	20	6	150	10	50	70	5,15
516-008-1	20	8	150	12	55	106	5,82



JUEGO BOTADORES CILÍNDRICOS



515-91-4	1	9	2-3-4-5-6-7-8-9-10 mm	622	26,15

JUEGO BOTADORES CILÍNDRICOS, PERFIL OCTOGONAL



519-92-4	1	6	2-3-4-5-6-8 mm	409	31,55

BOTADOR CILÍNDRICO REDONDO, LARGO

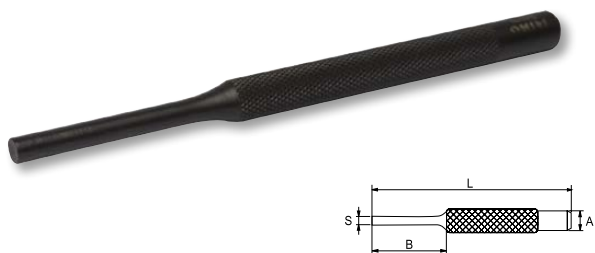

- Acabado: Pavonado
- UNE 16575

		S mm	L mm	A mm	B mm		€
517-120-1	25	2	120	8	30	33	3,82
517-130-1	25	3	130	8	40	35	3,94
517-135-1	25	4	135	8	45	37	4,01
517-140-1	25	5	140	10	50	60	4,09
517-145-1	20	6	145	10	55	64	4,18
517-150-1	20	8	150	12	60	100	4,53

BOTADOR CILÍNDRICO OCTOGONAL, LARGO

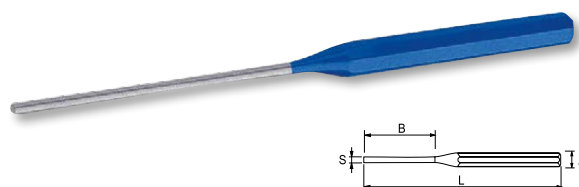

- Acabado: Lacado, pintado en azul
- Perfil octogonal
- Serie larga

		S mm	L mm	A mm	B mm		€
518-004-1	20	4	175	10	80	61	5,79
518-006-1	20	6	175	10	80	72	5,79

JUEGO BOTADORES CILÍNDRICOS, SERIE LARGA



517-91-4	1	6	2-3-4-5-6-8 mm	355	24,61





GOLPEO

CORTAFRÍOS ELECTRICISTA

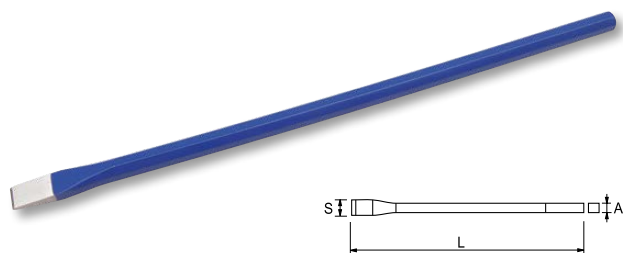

- Acabado: Lacado, pintado en azul
- Cromo molibdeno vanadio

R		L mm	S mm	A mm	g	€
503-200-1	20	200	12	8	93	6,06
503-250-1	20	250	12	8	119	6,31
503-300-1	20	300	12	8	142	7,25

JUEGO BOTADORES Y CINCELES, 6 piezas



R				g	€
519-93-4	1	6	160x85x12 mm	600	32,03
504-150-1					
506-150-1					
512-010-1					
514-003-1, 514-004-1					
516-005-1					

TRAZADOR PUNTA DURA



- Adecuado para el marcado en superficies duras
- Longitud total 150 mm

R		L mm	g	€
511501	1	150	39	5,80

BARRA PARA DESENCOFRADOR



- Herramienta para industria pesada
- Permite el acceso a espacios reducidos
- Con garra especialmente diseñada para facilitar la extracción
- Acabado liso y pintura de alta calidad para un uso cómodo

R		Ø mm	L mm	g	€
WB-300-2	1	14	346	450	29,44
WB-500-2	1	16	487	1.100	30,39
WB-625-2	1	17	685	1.450	34,32
WB-710-2	1	17	704	1.950	36,28
WB-900-2	1	20	890	2.850	39,03



MARTILLOS

MARTILLO DE CARPINTERO CON MANGO DE MADERA HICKORY



- El mango se une a la cabeza con dos cuñas metálicas y una de madera

Q	Paquete	g	A mm	B mm	L mm	g	€
520-41-2	6	16	450	29	130	330	710 16,07
520-61-2	6	20	560	30	140	333	820 16,78

REPUESTO DE MANGO DE MADERA HICKORY PARA MARTILLO DE CARPINTERO



- Suministrado con sus correspondientes cuñas

Q	Paquete	g	€
520-42-2	12	520-41-2 / 520-61-2	160 5,98

MARTILLO DE UÑA CON MANGO DE MADERA HICKORY



- Mango cónico

Q	Paquete	g	A mm	B mm	L mm	g	€
521-51-2	6	350	28.2	107.3	330	500	16,04
521-71-2	6	475	31.1	118.3	330	625	17,50
521-81-2	6	550	31.6	125.5	330	700	18,96

MANGO DE MADERA HICKORY PARA MARTILLO DE UÑA



- Mango de madera cónico

Q	Paquete	g	€
521-52-2	18	521-51-2 / 521-71-2	160 9,03
521-82-2	18	521-81-2	160 9,19

MARTILLO DE CARPINTERO CON MANGO DE FIBRA



- Mango encolado a la cabeza
- Mango trimaterial con el interior de fibra y recubierto de polipropileno y elastómero para un buen agarre

Q	Paquete	g	A mm	B mm	L mm	g	€
520-43-2	6	16	450	29	130	330	710 17,67
520-63-2	6	20	560	30	140	333	820 18,45

MARTILLO DE CARPINTERO DE BOLSILLO



- Cabeza pegada al mango con resina especial
- Mango trimaterial con el interior de fibra y recubierto de polipropileno y elastómero para un buen agarre
- Alojamiento en la cabeza imantado para clavos

Q	Paquete	g	A mm	B mm	L mm	g	€
520-13S-1	6	8	227	23	105	160	300 9,73

MARTILLO DE UÑA CON MANGO DE FIBRA VIDRIO



- Mango trimaterial con el interior de fibra y recubierto de polipropileno y elastómero para un buen agarre

Q	Paquete	g	A mm	B mm	L mm	g	€
521-53-2	6	350	28.2	107.3	330	500	15,32
521-73-2	6	475	31.1	118.3	330	625	16,39
521-83-2	6	550	31.6	125.5	327	700	17,47

MANGO DE FIBRA PARA MARTILLO DE UÑA



- Mango trimaterial con el interior de fibra y recubierto de polipropileno y elastómero para un buen agarre

Q	Paquete	g	€
521-54-2	18	521-53-2 / 521-73-2	160 6,25
521-84-2	18	521-83-2	160 6,39





MARTILLOS

MARTILLO DE PEÑA
CON MANGO DE MADERA HICKORY

- Mango unido a la cabeza con cuña metálica redonda

R			A mm	B mm	L mm	g	€
522-21-2	12	170	20	91	282	270	11,67
522-31-2	6	270	25	107	291	380	14,58
522-41-2	6	460	30	120	311	680	17,50

MARTILLO PARA MECÁNICO TIPO ALEMÁN DIN
CON MANGO MADERA HICKORY

- Mango unido a la cabeza con cuña metálica redonda

R			A mm	B mm	L mm	g	€
525-11-2	6	100	17	90	270	250	5,49
525-21-2	6	200	19	95	280	280	12,15
525-31-2	6	300	23	105	300	420	13,41
525-41-2	6	500	27	118	320	650	18,24
525-61-2	6	800	33	130	350	990	22,31
525-71-2	4	1.000	36	135	360	1.220	25,52
525-81-2	4	1.500	42	145	380	1.790	29,48
525-91-2	4	2.000	45	150	380	2.300	20,45

MANGO DE MADERA HICKORY PARA
MARTILLO DE PEÑA

- Suministrado con una cuña redonda

R			g	€
522-22-2	18	522-21-2	63	6,63
522-32-2	18	522-31-2	100	8,31
522-42-2	18	522-41-2	140	8,60

MANGO MADERA HICKORY PARA
MARTILLO TIPO ALEMÁN DIN

- Suministrado con una cuña metálica redonda

R			g	€
525-12-2	12	525-11-2	96	2,60
525-22-2	12	525-21-2	86	3,93
525-32-2	12	525-31-2	93	5,11
525-42-2	12	525-41-2	136	6,43
525-62-2	12	525-61-2	212	7,59
525-72-2	12	525-71-2	260	8,47
525-82-2	12	525-81-2	298	9,19
525-92-2	12	525-91-2	344	9,79

MARTILLO DE PEÑA
CON MANGO DE FIBRA VIDRIO

- Mango encolado a la cabeza
- Mango trimaterial con el interior de fibra y recubierto de polipropileno y elastómero para un buen agarre

R			A mm	B mm	L mm	g	€
522-23-2	12	170	20	91	282	270	12,25
522-33-2	6	270	25	107	291	380	15,32
522-43-2	6	460	30	120	311	680	18,38

MARTILLO PARA MECÁNICO TIPO ALEMÁN DIN
CON MANGO DE FIBRA VIDRIO

- Mango encolado a la cabeza
- Mango trimaterial con el interior de fibra y recubierto de polipropileno y elastómero para un buen agarre

R			A mm	B mm	L mm	g	€
525-43-2	6	500	27	118	330	735	20,06



**MARTILLO RIVOIR
CON MANGO DE MADERA HICKORY**



- Mango unido a la cabeza con cuña metálica redonda

Q	Paquete	g	A mm	B mm	L mm	g	€
526-31-2	4	250	25	81.5	265	350	11,75
526-41-2	4	400	30	92	280	520	13,08
526-51-2	4	630	35	103	300	800	16,74
526-61-2	4	800	40	110	330	1.000	19,39
526-71-2	4	1.150	45	124	350	1.400	22,45
526-91-2	4	2.000	50	138	380	2.250	22,69

**MANGO DE MADERA HICKORY PARA
MARTILLO RIVOIR**



- Suministrado con su correspondiente cuña metálica redonda

Q	Paquete	g	€
526-32-2	12	526-31-2	93 3,93
526-42-2	12	526-41-2	136 4,38
526-52-2	12	526-51-2	212 5,98
526-62-2	12	526-61-2	260 7,29
526-72-2	12	526-71-2	298 9,19
526-92-2	12	526-91-2	344 10,06

MARTILLO RIVOIR CON MANGO DE FIBRA VIDRIO



- Mango encolado a la cabeza
- Mango trimaterial con el interior de fibra y recubierto de polipropileno y elastómero para un buen agarre

Q	Paquete	g	A mm	B mm	L mm	g	€
526-53-2	6	630	35	103	330	630	18,42

**MARTILLO DE BOLA
CON MANGO DE MADERA HICKORY**



- Mango unido a la cabeza con dos cuñas metálicas y una de madera

Q	Paquete	oz	g	A mm	B mm	L mm	g	€
527-31-2	6	B	12	340	27	87	318	440 12,06
527-41-2	6	C	16	455	30	97	318	560 13,81
527-51-2	6	D	20	560	33	106	318	720 15,83
527-61-2	6	E	24	680	35	116	343	920 16,42
527-71-2	6	F	32	910	37	127	343	1.148 17,08
527-81-2	6	G	40	1.135	38	134	378	1.400 18,45
527-91-2	6	H	48	1.360	40	144	385	1.640 20,40

**REPUESTO DE MANGO DE MADERA HICKORY PARA
MARTILLO DE BOLA**



- Suministrado con sus dos cuñas metálicas y una de madera

Q	Paquete	g	€
527-32-2	18	527-31-2 (B) / 527-41-2 (C) / 527-51-2 (D)	100 6,86
527-52-2	12	527-61-2 (E) / 527-71-2 (F)	160 9,77
527-82-2	12	527-81-2 (G) / 527-91-2 (H)	220 10,65

MARTILLO DE BOLA CON MANGO FIBRA DE VIDRIO



- Mango encolado a la cabeza
- Mango trimaterial con el interior de fibra y recubierto de polipropileno y elastómero para un buen agarre

Q	Paquete	oz	g	A mm	B mm	L mm	g	€
527-33-2	6	B	12	340	27	90	317	500 13,27
527-43-2	6	C	16	455	30	100	320	600 15,19
527-53-2	6	D	20	560	33	108	324	760 17,41
527-63-2	6	E	24	680	35	120	335	920 17,62
527-73-2	6	F	32	910	37	131	337	1.148 18,79
527-83-2	6	G	40	1.135	38	139	387	1.400 20,30
527-93-2	6	H	48	1.360	40	148	390	1.640 22,45





MARTILLOS

MACETA DE ALBAÑIL CON MANGO DE MADERA HICKORY



- Mango unido a la cabeza con dos cuñas metálicas redondas y una de madera recta

€			A mm	B mm	L mm		€
530-03-2	6	700	35	110	280	800	13,71
530-05-2	6	1.000	38	120	280	1.200	15,22
530-07-2	6	1.250	43	135	280	1.400	17,02

MACETA CON MANGO DE MADERA HICKORY



- Mango unido a la cabeza con cuña metálica redonda

€			A mm	B mm	L mm		€
531-05-2	6	1.000	40	95	260	1.155	21,15
531-07-2	6	1.250	43	100	260	1.405	21,88
531-08-2	4	1.500	45	110	280	1.675	22,60
531-09-2	2	2.000	50	120	300	2.235	25,52

MANGO DE MADERA HICKORY PARA MACETA



- Suministrado con dos cuñas metálicas redondas y una de madera recta

€				€
530-13-2	12	530-03-2	145	9,60
530-15-2	12	530-05-2 / 530-07-2	159	9,60

MANGO DE MADERA PARA MACETA



- Suministrado con una cuña metálica redonda

€				€
531-15-2	12	531-05-2	165	5,39
531-17-2	12	531-07-2	168	5,39
531-18-2	12	531-08-2	205	7,59
531-19-2	12	531-09-2	231	7,59

MAZA DE GOMA

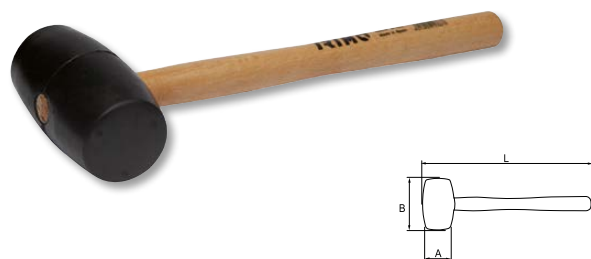

- Para colocación de suelos y paredes

€		A mm	B mm	L mm		€
529251	1	55	90	320	250	6,73
529261	1	65	115	340	440	8,09
529271	1	75	125	360	600	10,76
529291	1	90	139	360	720	12,15



MARTILLO ANTIRREBOTE



- Mango de madera

€		S mm	A mm	L mm	g	€
529611	6	35	115	370	500	24,14
529621	6	50	120	390	1.000	39,90
529631	6	60	125	420	1.560	51,92

BOCAS DE REPUESTO PARA MARTILLO ANTIRREBOTE



- Compatible con 529611, 529621 y 529631

€		A mm	L mm	g	€
529701	6	25	35	20	2,53
529711	6	28	50	50	4,03
529721	6	30	60	60	5,58

MANGO MADERA PARA MARTILLO ANTIRREBOTE



- Mango martillo antirrebote

€			g	€
529801	1	529611	90	3,00
529811	1	529621	140	3,22
529821	1	529631	215	3,29

MARTILLO BOCA NYLON



- Mango metálico, empuñadura de caucho

€		S mm	A mm	L mm	g	€
529021	6	28	80	255	325	15,92
529031	6	35	100	285	650	21,23
529041	6	44	125	300	1.105	30,03

MARTILLO BOCA NYLON



- Mango de madera

€		S mm	A mm	L mm	g	€
529151	6	22	65	215	145	7,45
529161	6	28	80	270	260	10,63
529171	6	35	100	295	500	13,21
529181	6	44	125	345	1.010	19,54
529191	6	55	140	380	1.480	37,62

BOCAS DE REPUESTO PARA MARTILLO



- Compatible con 529151, 529161, 529171, 521181 y 521191.

€		A mm	L mm	Ø mm	g	€
529061	10	12	22	8	10	1,35
529071	10	19	28	9	15	1,86
529081	10	22	35	10	20	2,62
529091	10	27	44	13	50	3,61
529101	10	32	55	16	80	5,48

MANGO MADERA PARA MARTILLO



- Mango de madera martillo boca nylon

€			g	€
529751	1	529151	50	1,77
529761	1	529161	70	2,03
529771	1	529171	100	2,26
529781	1	529181	150	2,47
529791	1	529191	170	2,71





FORMONES

JUEGO 3 FORMONES



- Mango mono material de polipropileno
- Acero Cr-V de alta calidad templado a 58±60 HRc
- Hojas rectificadas de precisión con máximo afilado
- Protector en la punta incluido

Artículo	Cant.	Paquetes	Medidas	Peso (g)	Precio (€)
805-3-C	1	3	12, 18, 25 mm	589	19,40

JUEGO 6 GUBIAS PARA TALLA



- Juego de gubias para talla, 6 piezas
- Mango de madera
- Varillas de acero cromo-vanadio de alta calidad
- Dureza hasta 55 HRc para garantizar la durabilidad y el mantenimiento
- Acabado con recubrimiento anti óxido
- Medidas: 160 mm

Artículo	Cant.	Paquetes	Medidas (mm)	Peso (g)	Precio (€)
806-6-B	1	6	160	221	30,38

	Cinzel cuadrado 12 mm
	Cinzel corte inclinado 12 mm
	Gubia curvada 6,5 mm
	Gubia recta 5 mm
	Gubia curvada 5 mm
	Gubia curvada 12 mm



09. ALICATES - TIJERAS Y CUCHILLOS



ALICATES

ALICATE CORTANTE

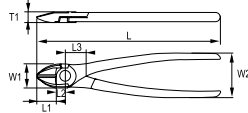

- Acero de alto rendimiento
- Dureza de corte 60-65 HRc
- ISO 5749
- Capacidad de corte:
 - 1- Alambre cobre: 0,50 mm
 - 2- Alambre semi duro: 1,60 mm

€		L	L1	L2	L3	W1	W2	T1	1 mm	2 mm	g	€
624-140-1	5	142	20.5	6	12	18.6	50	10	Ø 0.5 mm	Ø 1.6 mm	170	10,59
624-160-1	5	160	21.5	7	13	21.6	50	11.5	Ø 0.5 mm	Ø 1.6 mm	200	11,33
624-180-1	5	176	24.5	7	14	25.6	50	12.5	Ø 0.5 mm	Ø 1.6 mm	250	12,45

ALICATE CORTANTE REFORZADO

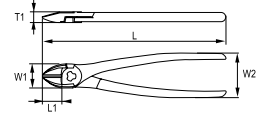

- Acero de alto rendimiento
- Dureza de corte 60-65 HRc
- ISO 5749
- Capacidad de corte:
 - 1- Alambre cobre: 0,50 mm
 - 2- Alambre semi duro: 1,80-2,00 mm

€		L	L1	W1	W2	T1	1 mm	2 mm	g	€
625-180-1	5	180	20.5	25.6	49	11.5	Ø 0.5 mm	Ø 1.8 mm	280	13,78
625-200-1	5	206	23	30	54	12	Ø 0.5 mm	Ø 2.0 mm	320	15,03

ALICATE UNIVERSAL

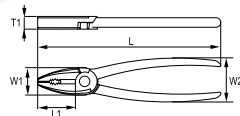

- Acero de alto rendimiento
- Dureza de corte 58-65 HRc
- ISO 5746
- Capacidad de corte:
 - 1- Alambre cobre: 1,00 mm
 - 2- Alambre semi duro: 1,60-2,00-2,50 mm

€		L	L1	W1	W2	T1	1 mm	2 mm	g	€
601-160-1	5	160	35	24	50	10	Ø 1.0 mm	Ø 1.6 mm	190	10,58
601-180-1	5	180	38	27	50	10	Ø 1.0 mm	Ø 2.0 mm	240	11,45
601-200-1	5	197	41.5	29.5	50	10	Ø 1.0 mm	Ø 2.5 mm	300	12,06

ALICATE BOCA SEMIRREDONDA

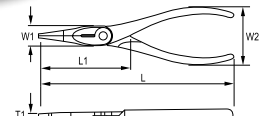

- Acero de alto rendimiento
- Dureza de corte 58-65 HRc
- ISO 5745
- Capacidad de corte:
 - 1- Alambre cobre: 1,00 mm
 - 2- Alambre semi duro: 1,60 mm

€		L	L1	W1	W2	T1	1 mm	2 mm	g	€
612-160-1	5	161	61.5	16.5	49	10	Ø 1.0 mm	Ø 1.6 mm	140	12,61
612-200-1	5	201	78	18	50	10.5	Ø 1.0 mm	Ø 1.6 mm	180	14,33

ALICATE BOCA SEMIRREDONDA CURVA

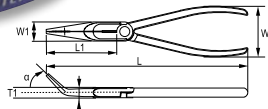

- Acero de alto rendimiento
- Dureza de corte 58-65 HRc
- ISO 5745
- Capacidad de corte:
 - 1- Alambre cobre: 1,00 mm
 - 2- Alambre semi duro: 1,60 mm

€		L	L1	W1	W2	T1	α	1 mm	2 mm	g	€
613-160-1	5	158	48	18	50	9.0	45°	Ø 1.0 mm	Ø 1.6 mm	132	13,87
613-200-1	5	197	74	18	50	10.5	45°	Ø 1.0 mm	Ø 1.6 mm	180	14,91

ALICATE BOCA PLANA

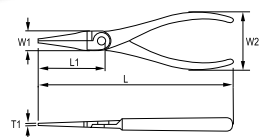

- Acero de alto rendimiento templado a 45-50 HRc
- ISO 5745

€		L	L1	W1	W2	T1	g	€
604-160-1	5	158	48	17	48	9	150	11,23
604-180-1	5	180	50	20	50	11	175	18,19



ALICATE BOCA REDONDA

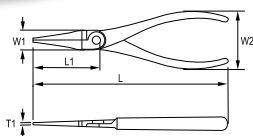

- Acero de alto rendimiento templado a 45-50 HRc
- ISO 5745

Q	📦	L mm	L1 mm	W1 mm	W2 mm	T1 mm	g	€
608-160-1	5	158	38	17	48	8.5	150	11,36

TENACILLA AJUSTE RÁPIDO

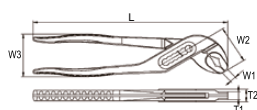

- Acero de alto rendimiento
- Dientes templados a 50-57 HRc
- ISO 8976

Q	📦	L mm	W1 mm	W2 mm	W3 mm	T1 mm	T2 mm	g	€
634-200-1	5	175	5.8	35.8	41	7	12	170	13,97
634-250-1	5	240	5	47.5	50	7.5	12.5	320	14,45
634-300-1	5	302	3	52.5	59.6	8	14.5	430	24,07

TENACILLA AJUSTE RÁPIDO

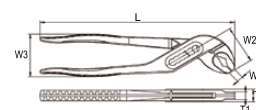

- Con botón para un ajuste rápido
- Acero de alto rendimiento
- Dientes templados a 50-57 HRc
- ISO 8976

Q	📦	L mm	W1 mm	W2 mm	W3 mm	T1 mm	T2 mm	g	€
634Q-250-1	5	240	5	47.5	50	7.5	12.5	320	20,47

JUEGOS ALICATES

JUEGO ALICATES



- Mangos bi-materiales

Q	📦	📦	📦	g	€
601-3-C	1	3	270 x 205 x 40	690	37,11
601-180-1					
624-160-1					
612-200-1					

JUEGO ALICATES Y TENACILLA



- Mangos bi-materiales

Q	📦	📦	📦	g	€
602-3-C	1	3	270 x 205 x 40	850	37,23
601-180-1					
624-160-1					
634-250-1					





MINI ALICATES

MINI ALICATE UNIVERSAL

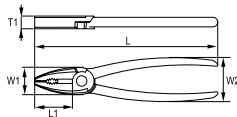

- Mini alicate universal para uso en electrónica y mecánica delicada
- Zonas de agarre para material plano y curvo, adecuado para diferentes usos
- Filo de corte para alambre blando
- Dureza de corte: 58-65 HRc
- Mango bi-material para más comodidad y control
- Con muelle de seguridad
- Material: Aleación de acero de alto rendimiento
- ISO 9655
- Capacidad de corte:
 - 1- Alambre cobre 0,5 mm
 - 2- Alambre semi duro: 0,8 mm

R		L mm	L1 mm	W1 mm	W2 mm	T1 mm			g	€
601M-125-1	5	120	22	15	85	7	0.5	0.8	60	10,99

MINI ALICATE BOCA PLANA

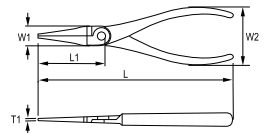

- Mini alicate para trabajos de electrónica y mecánica de precisión
- Bocas finas para sujeción de componentes delicados
- Dureza de corte: 42-50 HRc
- Mango bi-material para más comodidad y control
- Con muelle de seguridad
- Material: Aleación de acero de alto rendimiento
- ISO 9655

R		L mm	L1 mm	W1 mm	W2 mm	T1 mm			g	€
604M-125-1	5	130	27	12	85	8			89	10,99

MINI ALICATE BOCA SEMIRREDONDA

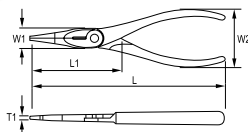

- Mini alicate boca semirredonda para uso en electrónica y mecánica delicada
- Zonas de agarre para material plano y curvo, adecuado para diferentes usos
- Filo de corte para alambre blando
- Dureza de corte: 58-65 HRc
- Mango bi-material para más comodidad y control
- Con muelle de seguridad
- Material: Aleación de acero de alto rendimiento
- ISO 9655
- Capacidad de corte:
 - 1- Alambre cobre 0,5 mm
 - 2- Alambre semi duro: 0,8 mm

R		L mm	L1 mm	W1 mm	W2 mm	T1 mm			g	€
612M-125-1	5	130	27	12	85	8	0.5	0.8	86	10,99

MINI ALICATE DE CORTE DIAGONAL

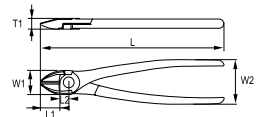

- Mini alicate de corte diagonal para uso en electrónica y mecánica delicada
- Filo de corte endurecido por inducción para alambre blando y duro
- Cabeza ovalada
- Dureza de corte: 58-65 HRc
- Mango bi-material para más comodidad y control
- Con muelle de seguridad
- Material: Aleación de acero de alto rendimiento
- ISO 9654
- Capacidad de corte:
 - 1- Alambre cobre 0,5 mm
 - 2- Alambre semi duro: 0,8 mm

R		L mm	L1 mm	W1 mm	W2 mm	T1 mm			g	€
624M-125-1	5	120	16	12	85	8	0.5	0.8	81	10,99



MINI ALICATE DE CORTE FRONTAL



- Mini alicate de corte frontal para uso en electrónica y mecánica delicada
- Filo de corte endurecido por inducción para alambre blando y duro
- Dureza de corte: 58-65 HRc
- Mango bi-material para más comodidad y control
- Con muelle de seguridad
- Material: Aleación de acero de alto rendimiento
- ISO 9654
- Capacidad de corte:
 - 1- Alambre cobre 0,5 mm
 - 2- Alambre semi duro: 0,8 mm

R	Paquete	A	B	C	D	E	F	G	1 mm	2 mm	g	€
626M-125-1	5	110	8	16	10	3	3	9	0.5	0.8	81	10,99

ALICATES PARA ELECTRICISTA

ALICATE PELACABLES

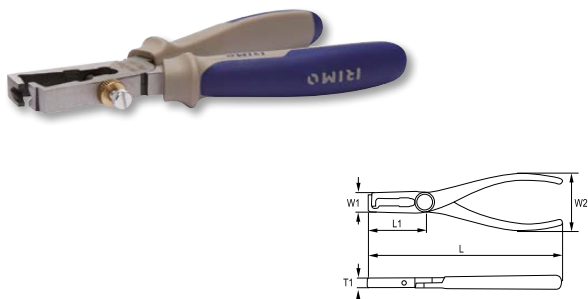

- Acero de alto rendimiento
- Templado a 45-50 HRc

R	Paquete	L	L1	W1	W2	T1	+	g	€
629-160-1	5	160	40.5	19	48	9	1-6	170	15,15

ALICATE CORTANTE PARA COBRE Y ALUMINIO

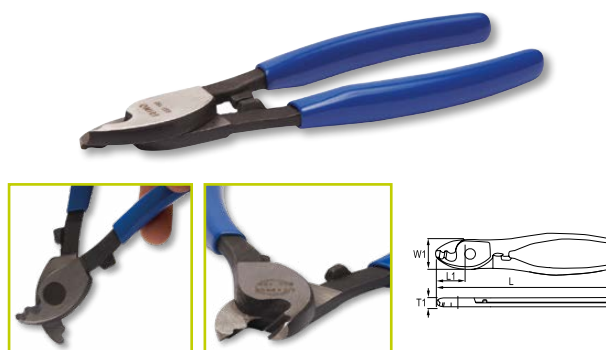

- Alicates para cortar y pelar cables de cobre y aluminio
- Acabado: Las superficies forjadas tienen un acabado fosfatado y pulido
- Material: Acero al carbono, mangos recubiertos de PVC

R	Paquete	L	L1	W1	T1	+	g	€	
655-160-1	5	160	25	25	10	50/35	10	160	21,82
655-200-1	5	200	28	30	12	70/50	13	280	26,77





ALICATES PARA ELECTRICISTA

ALICATE PARA TERMINALES AISLADOS



ALICATE PARA TERMINALES NO AISLADOS



- Alicates para cortar, pelar y engastar terminales aislados
- Fabricados en acero templado
- Prensa terminales: 1,5/2,5/6 mm²
- Corta cables: M2.6-M5.0
- Capacidad de pelado: 0,75-6,0 mm²

- Alicates para cortar, pelar y engastar terminales no aislados
- Fabricados en acero templado
- Prensa terminales: 1,5/2,5/6 mm²
- Corta cables: M2.6-M5.0
- Capacidad de pelado: 0,75-6,0 mm²

€	📦	L	A	C	🔗	🔗	✂️	✂️	✂️	📐	€
		mm	mm	mm	mm ²	AWG	mm ²	AWG	mm ²	g	
630-B1-1	12	220	38	3	1.5-6.0	20-10	0.75-6.0	20-10	0.75-6.00	220	10,94

€	📦	L	A	C	🔗	🔗	✂️	✂️	✂️	📐	€
		mm	mm	mm	mm ²	AWG	mm ²	AWG	mm ²	g	
630-B2-1	12	220	38	3	1.5-6.0	14-10	0.75-6.0	18-12	0.75-6.00	220	10,94

ALICATE PARA TERMINALES NO AISLADOS TIPO FASTON



JUEGO DE ALICATE PARA TERMINALES AISLADOS CON 60 TERMINALES



- Alicates para cortar, pelar y engastar terminales no aislados Tipo Faston
- Fabricados en acero templado
- Prensa terminales: 1,5/2,5/6 mm²
- Corta cables: M2.6-M5.0
- Capacidad de pelado: 0,75-6,0 mm²

- Juego con alicate para cortar, pelar y engastar terminales aislados y 60 terminales aislados
- Fabricados en acero templado
- Prensa terminales: 1,5/2,5/6 mm²
- Corta cables: M2.6-M5.0
- Capacidad de pelado: 0,75-6,0 mm²

€	📦	L	A	C	🔗	🔗	✂️	✂️	✂️	📐	€
		mm	mm	mm	mm ²	AWG	mm ²	AWG	mm ²	g	
630-B3-1	12	220	38	3	1.5-6.0	14-10	0.75-6.0	18-12	0.75-6.00	220	10,94

€	📦	📦	📦	📦	€
630-61B1-4	1	60 + 1	24 x 160 x 270	370	20,72



JUEGO DE TERMINALES AISLADOS Y CONECTORES DE ENCHUFE, 295 piezas



- Caja de plástico con compartimentos
- Contenido:
 - 45 piezas de manguitos terminales aislados con diferentes diámetros
 - 250 piezas de conectores macho aislados con diferentes formas y diámetros

Artículo	Caja	Contenido	Dimensiones (mm)	Peso (g)	Precio (€)
630-295T-4	1	295	30 x 115 x 220	250	26,32

JUEGO DE ALICATES PARA ENGASTAR CON MORDAZAS INTERCAMBIABLES



- Caja moldeada por soplado
- Alicata de carraca resistente con mangos bimateriales para un agarre perfecto
- Contenido:
 - Mordaza para terminales de barril abierto no aislados 0,5-6 mm² / AWG 22-10
 - Mordazas para terminales aislados 0,5-6 mm² / AWG 22-10
 - Mordaza para terminales de cable doble sin aislamiento 6-16 mm² / AWG 10-6
 - Mordaza para terminales de cable 4-35 mm² / AWG 10-35
 - Mordaza para terminales no aislados 0,5-10 mm² / AWG 22-8

Artículo	Caja	Contenido	Dimensiones (mm)	Peso (g)	Precio (€)
630-5HD-4	1	5	60 x 250 x 290	450	91,45

ALICATES SEGURIDAD

ALICATE UNIVERSAL AISLADO

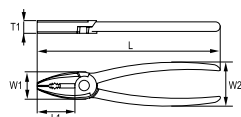

- Para trabajos en baja tensión hasta 1000 V
- Acero de alto rendimiento
- Dureza de corte 58-65 HRc
- ISO 5746
- Capacidad de corte:
 - 1- Alambre cobre: 1,00 mm
 - 2- Alambre semi duro: 1,60-2,00-2,50 mm

Artículo	Caja	L (mm)	L1 (mm)	W1 (mm)	W2 (mm)	T1 (mm)	Ø 1 mm	Ø 2 mm	Peso (g)	Precio (€)
601V-160-1	5	160	35	24	50	10	Ø 1.0 mm	Ø 1.6 mm	190	18,31
601V-180-1	5	180	38	27	50	10	Ø 1.0 mm	Ø 2.0 mm	240	20,39
601V-200-1	5	197	41.5	29.5	50	11	Ø 1.0 mm	Ø 2.5 mm	300	22,56

ALICATE BOCA PLANA AISLADO

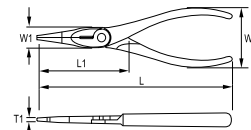

- Para trabajos en baja tensión hasta 1000 V
- Acero de alto rendimiento
- Dureza de corte 58-65 HRc
- ISO 5745

Artículo	Caja	L (mm)	L1 (mm)	W1 (mm)	W2 (mm)	T1 (mm)	Peso (g)	Precio (€)
604V-160-1	5	158	48	17	50	9	150	22,73



ALICATES SEGURIDAD

ALICATE BOCA SEMIRREDONDA AISLADO

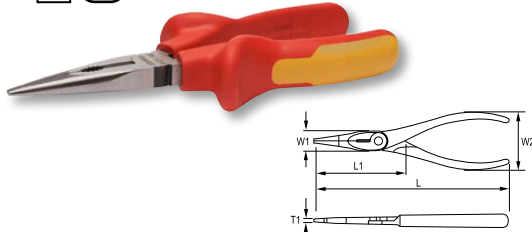

- Para trabajos en baja tensión hasta 1000 V
- Dureza de corte 58-65 HRc
- ISO 5746
- Capacidad de corte:
 - 1- Alambre cobre: 1,00 mm
 - 2- Alambre semi duro: 1,60 mm

Q	📦	L	L1	W1	W2	T1	1 mm	2 mm	g	€
612V-160-1	5	161	61.5	16.5	49	10	Ø 1.0 mm	Ø 1.6 mm	140	19,39
612V-200-1	5	201	78	18	50	10.5	Ø 1.0 mm	Ø 1.6 mm	180	22,10

ALICATE BOCA SEMIRREDONDA CURVA AISLADO

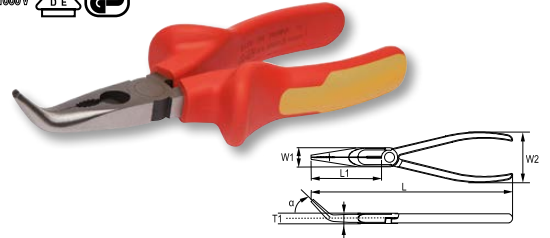

- Para trabajos en baja tensión hasta 1000 V
- Acero de alto rendimiento
- Dureza de corte 58-65 HRc
- ISO 5745
- Capacidad de corte:
 - 1- Alambre cobre: 1,00 mm
 - 2- Alambre semi duro: 1,60 mm

Q	📦	L	L1	W1	W2	T1	α	1 mm	2 mm	g	€
613V-160-1	5	158	50	18	18	9.0	45°	Ø 1.0 mm	Ø 1.6 mm	132	20,44
613V-200-1	5	197	74	18	50	10.5	45°	Ø 1.0 mm	Ø 1.6 mm	180	23,92

ALICATE CORTANTE AISLADO

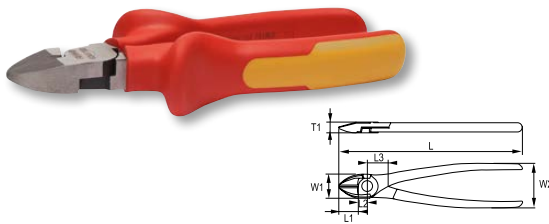

- Para trabajos en baja tensión hasta 1000 V
- Acero de alto rendimiento
- Dureza de corte 60-65 HRc
- ISO 5749
- Capacidad de corte:
 - 1- Alambre cobre: 0,50 mm
 - 2- Alambre semi duro: 1,60 mm

Q	📦	L	L1	L2	L3	W1	W2	T1	1 mm	2 mm	g	€
624V-140-1	5	142	20.5	7	13	18.6	50	10.0	Ø 0.5 mm	Ø 1.6 mm	170	16,75
624V-160-1	5	155	21.5	7	13	21.6	50	11.5	Ø 0.5 mm	Ø 1.6 mm	200	18,77

ALICATE CORTANTE REFORZADO AISLADO

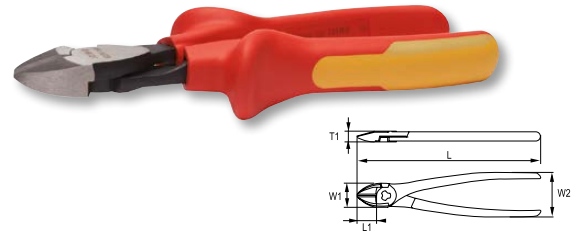
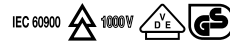

- Para trabajos en baja tensión hasta 1000 V
- Acero de alto rendimiento
- Dureza de corte 60-65 HRc
- ISO 5749
- Capacidad de corte:
 - 1- Alambre cobre: 0,50 mm
 - 2- Alambre semi duro: 1,80 mm

Q	📦	L	L1	W1	W2	T1	1 mm	2 mm	g	€
625V-180-1	5	180	20.5	25.6	49	11.5	Ø 0.5 mm	Ø 1.8 mm	280	21,02



ALICATE PELACABLES AISLADO

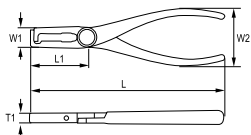

- Para trabajos en baja tensión hasta 1000 V
- Acero de alto rendimiento
- 45-50 HRc

629V-160-1	5	L mm	L1 mm	W1 mm	W2 mm	T1 mm	± mm	g	€
629V-160-1	5	160	40.5	19	48	9	1-6	170	24,63

TENACILLA AISLADA

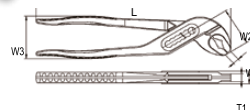

- Para trabajos en baja tensión hasta 1000 V
- Acero de alto rendimiento
- Dientes templados a 50-57 HRc
- ISO 8976

634V-250-1	5	L mm	W1 mm	W2 mm	W3 mm	T1 mm	T2 mm	g	€
634V-250-1	5	240	5	47.5	50	7.5	12.5	310	26,48

JUEGOS ALICATES SEGURIDAD

JUEGO DE ALICATES AISLADOS



- Para trabajos en baja tensión hasta 1000 V
- Acero de alto rendimiento
- IEC 60900

601V-3-C	1	3	270 x 205 x 40	690	61,26
624V-160-1				601V-180-1	
612V-200-1					

TENAZAS

TENAZA DE CARPINTERO

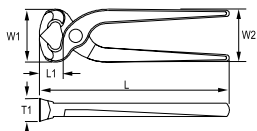

- Dureza de corte 58-64 HRc
- ISO 9243
- Capacidad de corte: Alambre semi duro: 1,60 mm

631-200-1	5	L mm	L1 mm	W1 mm	W2 mm	T1 mm	± mm	g	€
631-200-1	5	200	23	53	45	24	1.6 mm	360	12,47

TENAZA DE ENCOFRADOR

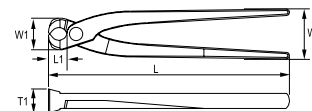

- Dureza de corte 58-64 HRc
- ISO 9242
- Capacidad de corte: Alambre semi duro: 1,60 mm

632-220-1	5	L mm	L1 mm	W1 mm	W2 mm	T1 mm	± mm	g	€
632-220-1	5	220	16	29.4	46	22	1.6 mm	350	11,30
632-250-1	5	250	18	33	46	24.5	1.6 mm	400	12,69
632-280-1	5	280	19	37	48	24.5	1.6 mm	460	14,99



TENAZAS

TENAZA DE ENCOFRADOR CON MANGOS PVC

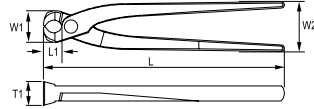

- Mangos recubiertos de PVC azul
- Dureza: dientes endurecidos a 58-68 HRc
- ISO 9242
- Capacidad de corte: 1,60 mm

R	Icono	L mm	L1 mm	W1 mm	W2 mm	T1 mm	Icono	g	€
632D-250-1	5	250	18	33	46	24.5	1.6 mm	400	14,87

CORTAVARILLAS

CORTAVARILLAS

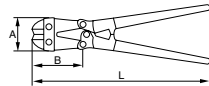

- Acero de alta resistencia
- Cuchillas con doble tratamiento térmico
- Acabado pavonado

R	Icono	L mm	A mm	B mm	Ø 80 kg/mm ²	Ø 160 kg/mm ²	Ø 120 kg/mm ²	g	€
651101	1 N.0	320	48	77	5	4	3	500	48,62
651111	1 N.1	470	66	104	7	6	5	1.785	77,79
651121	1 N.2	630	85	137	9	8	7	2.860	93,52
651131	1 N.3	750	100	160	11	9	8	4.410	122,76
651141	1 N.4	900	120	182	13	10	9	5.800	159,61

CABEZA DE REPUESTO PARA CORTAVARILLAS



R	+ M8	+ M10-12	Icono	A mm	B mm	g	€
651201N	651201N2	1	651101	48	77	180	35,03
651211N	651211N2	1	651111	66	104	370	41,74
651221N	651221N2	1	651121	85	137	875	50,18
651231N	651231N2	1	651131	100	160	1.295	65,89
651241N	651241N2	1	651141	120	182	1.930	85,03



ALICATES PARA ANILLOS O ARANDELAS

ALICATE RECTO PARA ANILLOS INTERIORES



- Acabado pavon para protección contra la corrosión
- Acero aleado de alto rendimiento
- Dureza 45-50 HRc
- Puntas forjadas rectas
- DIN 5256

R	Icono	L mm	B mm	E mm	Icono	Icono	g	€	
621551		5	140	38	0.8	8 - 13	1	80	16,90
621561		5	140	38	1.2	12 - 25	1	80	16,90
621571		5	180	57	1.7	19 - 60	1	170	19,30
621581		5	225	69	2.2	40 - 100	1	275	23,98
621591		1	310	95	3.1	85 - 165	1	490	31,86

ALICATE CURVO PARA ANILLOS INTERIORES



- Acabado pavon para protección contra la corrosión
- Acero aleado de alto rendimiento
- Dureza 45-50 HRc
- Puntas forjadas curvadas
- DIN 5256

R	Icono	L mm	B mm	E mm	Icono	Icono	g	€	
621651		5	127	25	0,8	8 - 13	1	80	17,13
621661		5	127	25	1,2	12 - 25	1	80	17,13
621671		5	165	43	1,7	19 - 60	1	170	19,76
621681		5	208	52	2,2	40 - 100	1	275	25,01
621691		1	289	74	3,1	85 - 165	1	490	35,16

ALICATE RECTO PARA ANILLOS EXTERIORES



- Acabado pavon para protección contra la corrosión
- Acero aleado de alto rendimiento
- Dureza 45-50 HRc
- Puntas forjadas rectas
- Muelle interno
- DIN 5254

R	Icono	L mm	B mm	E mm	Icono	Icono	g	€	
621751		5	140	38	0.8	3 - 10	1	80	17,71
621761		5	140	38	1.2	10 - 25	1	80	17,71
621771		5	180	57	1.7	19 - 60	1	170	19,64
621781		5	225	69	2.2	40 - 100	1	275	23,87
621791		1	295	95	3.1	85 - 165	1	490	35,39

ALICATE CURVO PARA ANILLOS EXTERIORES



- Acabado pavon para protección contra la corrosión
- Acero aleado de alto rendimiento
- Dureza 45-50 HRc
- Puntas forjadas curvadas
- Muelle interno
- DIN 5254

R	Icono	L mm	B mm	E mm	Icono	Icono	g	€	
621851		5	127	25	0.8	3 - 10	1	80	17,93
621861		5	127	25	1.2	10 - 25	1	80	17,93
621871		5	165	43	1.7	19 - 60	1	170	20,32
621881		5	208	52	2.2	40 - 100	1	275	25,01
621891		1	295	74	3.1	85 - 165	1	490	35,39

JUEGO DE ALICATES



- Acabado pavon para protección contra la corrosión
- Acero aleado de alto rendimiento
- Dureza 45-50 HRc
- Puntas forjadas
- DIN 5254

R	Icono	Icono	Icono	g	€
601911		X	260 x 220 x 30	750	90,85
621571	Icono	Icono	621671	Icono	Icono
621771	Icono	Icono	621871	Icono	Icono





TIJERAS CORTACHAPAS

CORTE RECTO



- Mandíbulas de acero cromo molibdeno forjadas para mayor resistencia
- Filos fresados con precisión
- Suave acción de corte y gran poder de agarre. Sistema palanca
- Mangos con doble inyección con zona antideslizante y muelle de retorno que mejora en confort
- Capacidad de corte: 1- Acero inox, 2- Acero laminado en frío

€	📦	L mm	1 mm	2 mm	g	€
658-250-1	1	250	0.7	1.2	390	21,34

CORTE DERECHA



- Mandíbulas de acero cromo molibdeno forjadas para mayor resistencia
- Filos fresados con precisión
- Suave acción de corte y gran poder de agarre. Sistema palanca
- Mangos con doble inyección con zona antideslizante y muelle de retorno que mejora en confort
- Capacidad de corte: 1- Acero inox, 2- Acero laminado en frío

€	📦	L mm	1 mm	2 mm	g	€
659-250-1	1	250	0.7	1.2	395	21,34

CORTE IZQUIERDA



- Mandíbulas de acero cromo molibdeno forjadas para mayor resistencia
- Filos fresados con precisión
- Suave acción de corte y gran poder de agarre. Sistema palanca
- Mangos con doble inyección con zona antideslizante y muelle de retorno que mejora en confort
- Capacidad de corte: 1- Acero inox, 2- Acero laminado en frío

€	📦	L mm	1 mm	2 mm	g	€
660-250-1	1	250	0.7	1.2	405	21,34

GRIPS

MORDAZA UNIVERSAL, BOCAS CURVAS CON CORTANTE

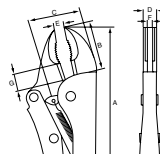

- Uso general, sujeción de barras, chapas, tuercas y tornillos
- Bocas fuertes, forjadas
- Acero de cromo molibdeno
- Niquelado

€	📦	A mm	B mm	C mm	D mm	E mm	F mm	G mm	Fe+ mm	g	€
64A-190-1	190	31	40	12	0-20	7	5	2	338	358	21,10
64A-235-1	225	38	48	12	0-35	7	6	3	543	556	24,08

MORDAZA UNIVERSAL, BOCAS RECTAS

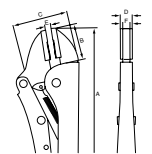

- Para chapas metálicas, barras pequeñas y piezas finas
- Bocas fuertes, reforzadas. Forjadas
- Acero de cromo molibdeno
- Niquelado

€	📦	A mm	B mm	C mm	D mm	E mm	F mm	g	€
64B-190-1	1	190	29	42	15	0-17	13	358	21,49
64B-235-1	1	225	32	54	17	0-21	13	556	24,08



GRIPS

MORDAZA GRIP DE BOCA LARGA



- Bocas de largo alcance, forjadas
- Las bocas tienen forma de sujeción recta y curva
- Acero de cromo molibdeno
- Niquelado

E		A mm	B mm	C mm	D mm	E mm	F mm	g	€
64L-165-1	1	165	52	25	9	6	0-18	195	16,29

MORDAZA PARA SOLDADURA TIPO "U"



- La forma en U permite una buena visión y acceso en trabajos de soldadura
- Forma de horquilla para incrementar la fuerza
- Acero de cromo molibdeno
- Niquelado

E		A mm	B mm	C mm	D mm	E mm	F mm	g	€
64W-300-1	1	263	75	70	75	70	44	832	32,58

MORDAZA DE ACERO CON SUJECIÓN C



- Forma de C para sujetar piezas voluminosas
- Acero cromo vanadio
- Niquelado

E		A mm	B mm	C mm	D mm	E mm	F mm	g	€
64C-300-1	1	275	90	140	14	0-65	7	775	33,27

MORDAZA DE ACERO, BOCAS OSCILANTES



- Forma de C para sujetar piezas voluminosas
- Oscilante, para sujetar piezas no paralelas e irregulares
- Acero cromo vanadio
- Niquelado

E		A mm	B mm	C mm	D mm	E mm	F mm	g	€
64CA-175-1	1	175	61	90	21	0-32	5	276	23,56
64CA-300-1	1	280	95	130	28	0-72	7	835	31,06
64CA-450-1	1	460	270	150	28	0-130	7	1280	52,47

MORDAZA DE ACERO, OSCILANTE, FINA



- Largo alcance
- Oscilante, para sujetar piezas no paralelas e irregulares
- Acero de cromo molibdeno
- Niquelado

E		A mm	B mm	C mm	D mm	E mm	F mm	g	€
64CAD-300-1	1	282	97	81	28	0-72	7	850	30,97

MORDAZA PLANA EN C

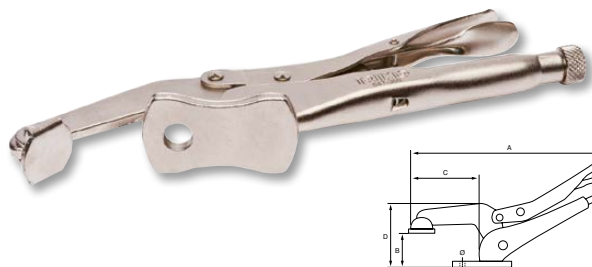

- Oscilante, para sujetar piezas no paralelas e irregulares
- Palanca oculta para evitar el desbloqueo no deseado
- Acero de cromo molibdeno
- Niquelado

E		A mm	B mm	C mm	D mm	Ø mm	g	€
64T-300-1	1	300	0-80	95	90	12.4	650	48,53





GRIPS

MORDAZA GRIP DE CUATRO POSICIONES

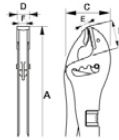

- Cromado plateado para protección contra la oxidación
- Con mordazas planas y convexas que pueden ajustarse en 4 posiciones diferentes para una mayor capacidad de agarre
- Agarra la mayoría de perfiles L,T y U

€		A mm	B mm	C mm	D mm	E mm	F mm	g	€
647-235-1	1	235	37	59	17	10	15	540	46,03

MORDAZA GRIP DE CUATRO POSICIONES

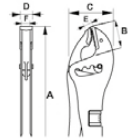

- Cromado plateado para protección contra la oxidación
- Con mordazas planas y convexas que pueden ajustarse en 4 posiciones diferentes para una mayor capacidad de agarre
- Mordazas extra largas con doble capacidad de agarre comparado con una mordaza estándar
- Agarra la mayoría de perfiles L,T y U

€		A mm	B mm	C mm	D mm	E mm	F mm	g	€
647-250-1	1	255	67	64	17	10	15	650	51,18

MORDAZA GRIP DE BOCAS CURVAS Y CORTANTE

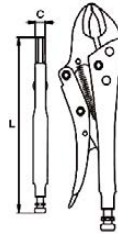

- Acero al cromo vanadio. Cromado
- Forma: bocas curvadas para usos generales
- Mango bi-material de agarre suave

€		L mm	C mm		g	€
648-140-1	1	140	7	28	160	15,19
648-185-1	1	185	8.5	41	345	15,80
648-250-1	1	225	10.5	48	525	16,71

MORDAZA GRIP DE NARIZ LARGA

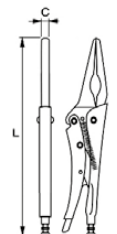

- Acero al cromo vanadio. Cromado
- Forma: diseño de la nariz larga y estrecha
- Mango bi-material de agarre suave

€		L mm	C mm		g	€
648-165-1	1	165	4.2	57	180	15,50

JUEGO DE MORDAZAS GRIP



- Mango bi-material de agarre suave
- Bolsa nylon enrollable

€			g	€
648-4-W	1	4	1.200	55,42

648-140-1, 648-185-1, 648-250-1

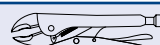

648-165-1



TENAZAS DE AJUSTE RÁPIDO

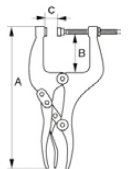

- Pavonadas
- Grapa de bloqueo con mordaza móvil para incrementar flexibilidad y el trabajo en general
- Uso en bancos de trabajo, fábricas de producción, trabajos de mantenimiento en general

€		A mm	B mm	C mm				g	€
645011	1	193	30	32	645-L075	645-YOKE	645-NUT	690	54,50
645021	1	196	30	70	645-L120	645-YOKE	645-NUT	765	57,96
645031	1	240	62	70	645-L120	645-YOKE	645-NUT	935	60,75
645041	1	240	62	150	645-L200	645-YOKE	645-NUT	1.180	75,11



REMACHADORA

REMACHADORA MANUAL



- Remachadora de cuatro boquillas intercambiables para medidas de remachado: 1,8-2,2-2,8-3,2 mm
- Para uso en aluminio, acero, acero inoxidable y cobre
- Incluye una llave para cambio de boquillas

E	📦	L mm	A mm	B mm	g	€
546-265-1	1	265	90	25	700	53,34



Repuestos para remachadora 546-265-1		📦	€
546-265-A	Juego componentes de las mordazas	1	14,73
546-265-B	Juego 4 boquillas	1	9,02

REMACHADORA DE TUERCAS



- Suministrado con boquillas y madrilos métrica M3, M4, M5 y M6
- Para tuercas de aluminio, acero y acero inoxidable

E	📦	L mm	A mm	B mm	g	€
548-275-1	1	270	100	23	700	95,33



Repuestos para remachadora 548-275-1		📦	€
548-275-M3	Boquilla y madriño M3	1	4,64
548-275-M4	Boquilla y madriño M4	1	4,64
548-275-M5	Boquilla y madriño M5	1	4,64
548-275-M6	Boquilla y madriño M6	1	4,64

REMACHADORA 2 BRAZOS



- Remachadora de dos manos para mayor efecto palanca
- Para remaches de aluminio, acero e inox con capacidad de remachado de 3,2; 4,0; 4,8; 6,0 y 6,8 mm
- El tubo transparente recoge los ribetes

E	📦	A mm	B mm	C mm	D mm	g	€
546021	1	520	22	58	160	1.800	177,45



Repuestos para remachadora 546021		€
546201	Boquilla Ø 4 mm	4,97
546211	Boquilla Ø 5 mm	4,97
546221	Boquilla Ø 6-6,4 mm	4,97
546251	Juego 3 mordazas	18,42
1467-A01	Tubo transparente	27,42

JUEGO DE REMACHADORA MANUAL



- 265 mm remachadora de uso general con cuatro cabezas intercambiables diferentes
- Para remaches de 2,4 mm; 3,0 a 3,2 mm; 4,0 mm y 4,8 mm
- Incluye una llave para cambiar las cabezas
- Para utilizar con aluminio, acero, acero inoxidable y remaches de cobre
- 160 remaches (40 de cada tamaño)
- Estuche de plástico

E	📦	X	g	€	
546-265-4	1	160	300 x 210 x 60	1.200	55,03



TIJERAS Y NAVAJAS DE ELECTRICISTA

CUTTER CUCHILLA SECCIONABLE, 9 MM



85x9x0.50 mm

Artículo	Paquetes	Longitud (mm)	Peso (g)	Precio (€)
667-135-1	12	133	56	3,90

CUTTER CUCHILLA SECCIONABLE, 18 MM



112x18x0.50 mm

Artículo	Paquetes	Longitud (mm)	Peso (g)	Precio (€)
666-156-1	12	157	106	6,58

CUTTER DE SEGURIDAD, 18 MM

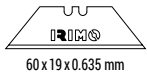

60x19x0.635 mm



CUCHILLO DE SEGURIDAD

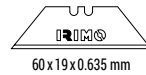

60x19x0.635 mm



- Hoja autorretráctil para mayor seguridad

Artículo	Paquetes	Longitud (mm)	Peso (g)	Precio (€)
668-150-1	12	150	157	4,94

- Cuchillo de seguridad
- Hoja retráctil

Artículo	Paquetes	Longitud (mm)	Peso (g)	Precio (€)
669-175-1	10	175	210	7,32

RASQUETA PARA VIDRIO CON CUCHILLAS INTERCAMBIABLES

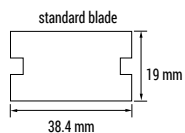

38.4 mm



- Ideal para eliminar pintura, pegamento, pegatinas o masilla de cristales, azulejos, paredes, suelos y otras superficies suaves
- Diseño ergonómico en dos materiales
- Sistema de retracción de la cuchilla para un almacenamiento seguro
- Compartimento con 5 cuchillas incluidas
- Medida adaptada a la palma de la mano, 130 mm
- Hojas estándar de 40 mm

Artículo	Paquetes	Longitud (mm)	Peso (g)	Precio (€)
538-140-1	1	135	65	5,41



CUCHILLOS MULTIUSOS CON FUNDA



- Cómodo mango que proporciona un agarre excelente
- Se suministra con una funda que se puede llevar en el cinturón
- Robusto cuchillo multiusos con sólida hoja de acero inoxidable

🇪🇸		A mm	L mm	g	€
672-220-1	12	100	220	233	8,15

CUCHILLO PLEGABLE



- Hoja de acero inoxidable 3Cr13
- Mango de acero inoxidable 106 mm
- Ligero y cómodo
- Incluye gancho para cinturón
- Longitud total: 178 mm
- Grosor de la hoja: 2,3 mm

🇪🇸		A mm	L mm	g	€
670-178-1	10	78	178	120	14,44

CUCHILLO PLEGABLE



- Hoja de acero inoxidable 3Cr13
- Mango negro 113 mm
- Ligero y cómodo
- Incluye gancho para cinturón
- Longitud total: 190 mm
- Grosor de la hoja: 2,6 mm

🇪🇸		A mm	L mm	g	€
669-190-1	10	77	190	130	16,85

CUCHILLO DE ELECTRICISTA



- Navaja de bolsillo para electricista con función pelacables, mango de madera

🇪🇸		A mm	L mm	g	€
664-200-1	10	85	200	83	12,90

CUCHILLO DE ELECTRICISTA



- Navaja de bolsillo para electricista de acero inoxidable con función pelacables, mango de plástico

🇪🇸		A mm	L mm	g	€
665-200-1	10	85	200	60	11,68

MULTIHERRAMIENTAS



- Multiherramienta plegable de acero inoxidable 3Cr13
- Longitud: 96 mm cerrada / 150 mm en total
- Estuche incluido para fácil transporte
- Incluye:
 - Tenaza
 - Alicata universal
 - Corta cables
 - Cuchillo
 - 5 Destornilladores planos
 - Abre latas
 - Sierra
 - Lima para madera y metal
 - Abre botellas
 - Tijeras
 - Destornillador Phillips

🇪🇸		L mm	A mm	g	€
671-150-1	10	150 (96)	255	27,67	





TIJERAS Y NAVAJAS DE ELECTRICISTA

TIJERAS DE ELECTRICISTA



- Tijeras de electricista con plástico protector para los dedos
- Curvatura en la hoja para pelar cables de hasta 43 mm

€		A mm	L mm	g	€
661051	10	42.5	130	70	9,83

TIJERAS DE ELECTRICISTA



- Tijeras de electricista reforzada con plástico protector para los dedos
- Curvatura en la hoja para pelar cables con mayor accesibilidad
- Capacidad de corte 38 mm
- Menor esfuerzo de corte

€		A mm	L mm	g	€
661061	10	38	152	130	15,15

TIJERAS DE ELECTRICISTA



- Cuerpo de acero que cubre toda la tijera
- Hoja micro dentada
- Mangos recubiertos de PVC
- Longitud corte 43 mm
- Funda de plástico con colgador giratorio

€		A mm	L mm	g	€
661-140-1	12	43	145	76	20,08



- Caja expositora 12 tijeras electricista

€		€
661-140-12-DISP	1	228,34

GANCHOS

JUEGO 4 GANCHOS, BI-COMPONENTE



- Para rascar, manipular o quitar anillos, muelles, soldaduras, etc.
- Largura: 170 mm
- Mango ligero bi-componente
- Material: Varillas de acero al carbono, puntas endurecidas 40 HRC
- Composición:
 - 1 Pico recto,
 - 1 gancho angulado 45°,
 - 1 gancho 90° y
 - 1 gancho completo

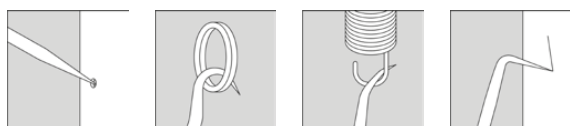

€				g	€
722-4-1	12	4	20 x 230 x 130	100	10,84

A close-up photograph of a male mechanic with dark hair and a beard, wearing a blue long-sleeved uniform. He is focused on working on the engine of a car with its hood open. He is holding a blue and silver puller tool in his right hand. A bright flashlight is directed at the engine area, creating a strong light source. The background is slightly blurred, showing more of the engine and the car's body. A yellow banner with black text is overlaid on the lower part of the image.

10. HERRAMIENTAS DE EXTRACCIÓN



EXTRACTORES

EXTRACTOR UNIVERSAL DE 2 BRAZOS

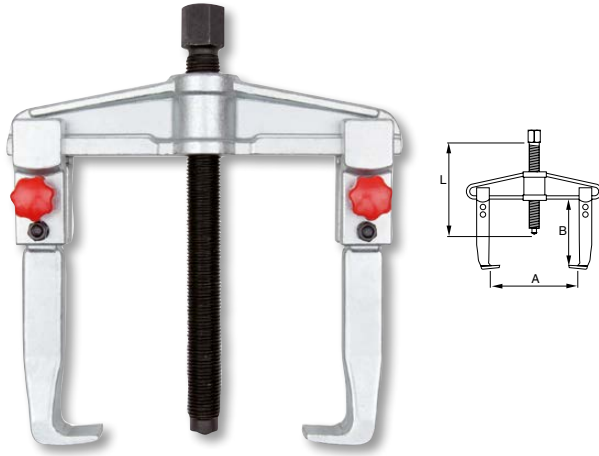

- Cuerpo y brazos fabricados en acero forjado
- Perfil con forma de viga, ligero y resistente
- Acabado galvanizado, con husillo templado por inducción
- Brazos forjados cromo-vanadio, máxima resistencia
- Girando los brazos, el extractor puede ser utilizado como externo o interno
- Uñas diseñadas para permitir el acceso a lugares estrechos
- Tuercas en PVC para un ajuste rápido y sencillo

Q	Paquete	A mm	B mm	L mm	T _h	g	€	
701-90-1	N1	1	90	100	130	4	900	68,37
701-130-1	N11	1	130	100	130	4	980	71,43
701-160-1	N2	1	160	150	210	6	2.450	118,36
701-200-1	N21	1	200	150	210	6	2.880	122,43
701-250-1	N3	1	250	205	280	8	6.950	204,91
701-350-1	N31	1	350	205	280	8	7.680	242,56



Q	Q	mm	mm	g	€	Q	L mm	g	€	Q	L mm	g	€
701-90-1	701-90-S	17	M14x1.5x130	175	7,29	701-90-K	95	528	21,91	701-90-B	136	315	17,00
701-130-1	701-90-S	17	M14x1.5x130	175	7,29	701-90-K	95	528	21,91	701-130-B	177	485	18,53
701-160-1	701-160-S	22	M20x2x210	575	14,22	701-160-K	150	1.058	42,62	701-160-B	217.5	890	33,16
701-200-1	701-160-S	22	M20x2x210	575	14,22	701-160-K	150	1.058	42,62	701-200-B	262	1.360	38,82
701-250-1	701-250-S	27	M27x2x280	1.275	36,85	701-250-K	202	3.262	110,43	701-250-B	330	2.750	85,86
701-350-1	701-250-S	27	M27x2x280	1.275	36,85	701-250-K	202	3.262	110,43	701-350-B	430	3.575	120,88

EXTRACTOR DOS GARRAS AUTOCENTRANTE

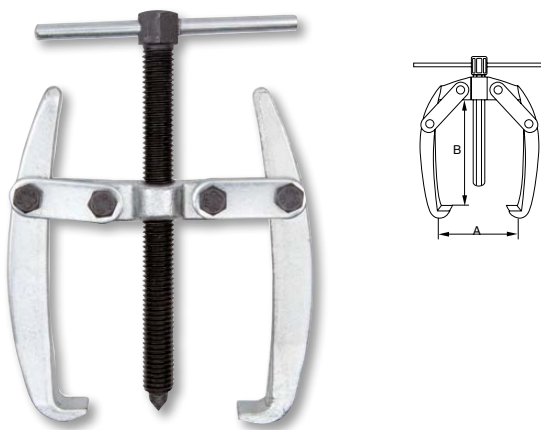

- Cuerpo y brazos de acero forjado
- Acabado galvanizado
- Ideal para extraer pequeñas partes como terminales de baterías, ruedas, rodamientos, etc.
- Los extremos de las garras se cierran automáticamente

Q	Paquete	A mm	B mm	T _h	g	€
702-40-1	1	60	40	0.50	180	22,39
702-65-1	1	65	65	0.50	190	24,12
702-80-1	1	80	80	1.00	220	42,01



Q	Q	mm	g	€	Q	L mm	g	€	Q	L mm	g	€	Q	L mm	g	€
702-40-1	702-40-S	M10x1.5x100	61	1,30	702-40-K	54.5	40	3,95			20	3,90			20	0,47
702-65-1	702-65-S	M10x1.5x105	63	1,65	702-65-K	88	74	4,85	702-40-B	42x13	20	3,90	702-40-P	33.5x3	20	0,47
702-80-1	702-80-S	M10x1.5x122	72	2,13	702-80-K	103	98	6,40			20	3,90			20	0,47



EXTRACTOR DE TRES GARRAS AUTOCENTRANTE

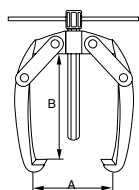

- Cuerpo y brazos de acero forjado
- Acabado galvanizado
- Ideal para extraer pequeñas partes como terminales de baterías, ruedas, rodamientos, etc.
- Los extremos de las garras se cierran automáticamente

Q	Q	A mm	B mm	1000 Tn	g	€
703-40-1	1	60	40	0.75	230	30,97
703-65-1	1	65	65	0.75	290	33,50
703-80-1	1	80	80	1.50	320	52,16



Q	Q	mm	g	€	Q	L mm	g	€	Q	L mm	g	€	Q	L mm	g	€
703-40-1	702-40-S	M10x1.5x100	61	1,30	702-40-K	54.5	40	3,95			20	3,90			20	0,47
703-65-1	702-65-S	M10x1.5x105	63	1,65	702-65-K	88	74	4,85	703-40-B	42x13	20	3,90	702-40-P	33.5x3	20	0,47
703-80-1	702-80-S	M10x1.5x122	72	2,13	702-80-K	103	98	6,40			20	3,90			20	0,47

EXTRACTOR MÚLTIPLE

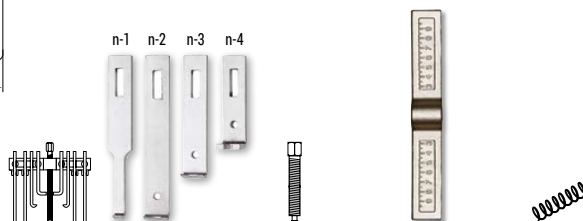
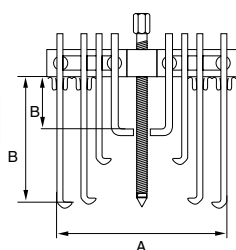

- Para ser utilizado como extractor interno o externo
- Se consigue gran longitud útil de trabajo atornillando entre sí las distintas garras

Q	Q	A (mm) min. - max.	B (mm) min. - max.	1000 Tn	g	€
713001	1	20 - 173	65 - 140	5	2.700	206,99
713011	1	75 - 250	77 - 182	10	6.000	307,22

Q	Q	€	Q	€	Q	€	Q	€	
713001	796511	n-1	20,96	796491	32,68	796501	52,07	796551	1,05
	796521	n-2	19,40						
	796531	n-3	19,40						
	796541	n-4	20,96						
713011	713511	n-1	27,08	713611	40,23	796561	102,85	796571	1,76
	713521	n-2	27,08						
	713531	n-3	28,77						
	713541	n-4	28,77						





EXTRACTORES

JUEGO DE PUNTAS EXTRACTORAS



- Juego completo de 15 extractores para cualquier tipo de espárragos o tornillos rotos
- El material NiCrMo confiere una alta calidad a las puntas
- Se suministra en una caja de plástico robusta y compacta

R	Paquete	Dimensiones	g	€
ZH1100	1	200 x 105 x 35	1.000	89,71

Hex	mm	€	Hex	mm	€		
1/2"	ZH1101	3	4,11	5/8"	ZH1108	1/8"	4,11
	ZH1102	4	4,11		ZH1109	3/16"	4,11
	ZH1103	5	4,11		ZH1115	1/2"	4,11
	ZH1104	5.5	4,11		ZH1110	1/4"	4,11
	ZH1105	6	4,11		ZH1111	3/8"	4,11
	ZH1106	8	4,11		ZH1112	11 mm	4,11
	ZH1107	10	4,11		ZH1113	12 mm	4,11
					ZH1114	14 mm	4,11

EXTRACTORES DE ESPÁRRAGOS



- Para extraer tornillos y pernos rotos
- Acabado: granulado
- Acero al carbono de alta calidad

R	Paquete	Dimensiones	g	€
716-5-1	1	90 x 58 x 15	5	# 1, 2, 3, 4, 5 M3-M18 120 20,82
716-8-1	1	215 x 130 x 50	8	# 1, 2, 3, 4, 5, 6, 7, 8 M3-M50 840 64,51

#	mm	Ø mm	L mm	g	€
716-M6-1	1	2.0	4.00	50	M 3-6 4 3,84
716-M8-1	2	2.8	4.30	58	M 6-8 6 5,37
716-M11-1	3	4.0	6.00	65	M 8-11 13 7,48
716-M14-1	4	6.3	7.50	75	M 11-14 20 9,18
716-M18-1	5	7.5	10.70	80	M 14-18 45 11,01
	6	10.3	15.00	85	M 18-25 95
	7	13.5	19.00	92	M 25-35 140
	8	20.6	24.00	97	M 35-50 240

VOLVEDOR



- Con carraca reversible: izda. – dcha. bloqueo
- Agarre paralelo
- Mordazas templadas
- Mango corredizo
- Acero cromado

R	Paquete	mm	L mm	g	€
718211	1	2.6 - 5.5	85	180	26,72
718231	1	4.6 - 8	110	300	34,48

TRONZATUERCAS



- Para separar tuercas atascadas sin dañar el tornillo
- Acero especial galvanizado
- Cabezal de repuesto disponible

R	Paquete	A mm	L mm	g	€
730011	1	32	126	M3-M16 6-27 440	796661 796671 55,76
730131	1	42	170	M14-M24 24-40 560	796681 796691 132,18



EXTRACTOR

EXTRACTOR MAGNÉTICO

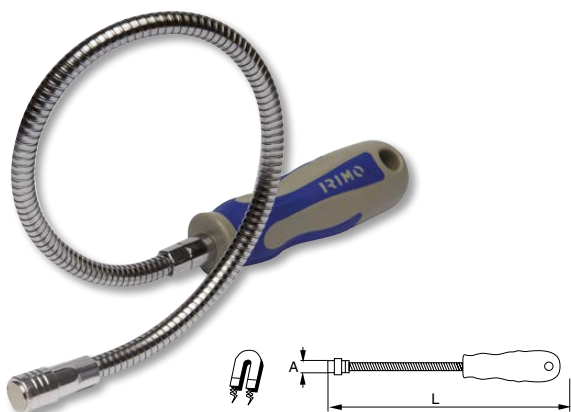

- Mango bicomponente con agujero para colgar y diseño antideslizante
- Varilla cromada pulida
- 720-1M-413: Imán neodimio extrafuerte capacidad 1 kg
- 720-3M-413: Imán neodimio extrafuerte capacidad 3 kg

🇪🇸		Ø mm	A mm	L mm			g	€
720-1M-413	1	10	10	550	413	110	130	30,97
720-3M-413	1	17	13	550	413	110	280	59,49

GANCHO EXTRACTOR CROMADO



- Para agarre de piezas muy pequeñas
- Eje flexible con el corazón de acero

🇪🇸			g	€
720031	1	650	80	5,74

EXTRACTOR DE GARRA MAGNÉTICO CON LUZ

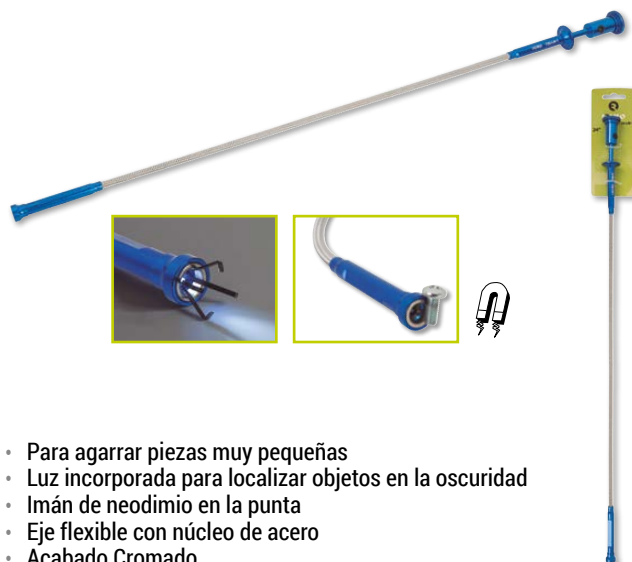

- Para agarrar piezas muy pequeñas
- Luz incorporada para localizar objetos en la oscuridad
- Imán de neodimio en la punta
- Eje flexible con núcleo de acero
- Acabado Cromado

🇪🇸			g	€
720-LM-1	1	625	120	12,40

PALANCA

PALANCA

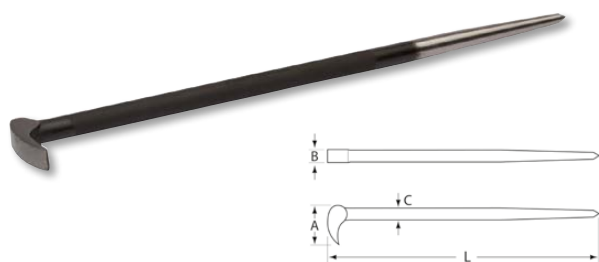

- Palanca polivalente 90° para trabajos en espacios confinados
- Acabado negro fosfatado con cabeza pulida y punta afilada
- Material: Aleación de acero especial endurecido

🇪🇸		A mm	B mm	C mm		g	€
066-400-1	1	44	14	14	406	450	33,47





PALANCA

JUEGO DE 4 PALANCAS ACODADAS



- Palancas con mangos de plástico muy ligeras
- Agarre cómodo para conseguir mayor potencia de elevación

R	📦	📏	g	€
ZH70610	1	645 x 115 x 35	1.400	31,50
ZH70611, ZH70612, ZH70613, ZH70614				

PALANCA ACODADA



- Palancas con mangos de plástico muy ligeras
- Agarre cómodo para conseguir mayor potencia de elevación

R	📦	L mm	g	€
ZH70611	1	210	200	8,42
ZH70612	1	310	300	10,84
ZH70613	1	460	400	16,85
ZH70614	1	610	500	20,46

PERFORADORES DE CHAPA

PERFORADORES DE CHAPA



- Perforadores de chapa
- Para un diámetro del agujero de 16 a 50 mm
- Zonas con superficie de corte para un corte más fácil
- Perno de cabeza hexagonal
- Para placas de chapa de acero de hasta 2 mm de espesor
- Para placas de acero inoxidable de hasta 1,2 mm de espesor
- Embalaje individual

R	📦	Ø mm	🔩	g	€
740-016-2	1	16	M 8	80	51,33
740-020-2	1	20	M 10	120	64,60
740-022-2	1	22	M 10	160	64,60
740-025-2	1	25	M 10	180	74,77
740-030-2	1	30	M 12	320	79,48
740-035-2	1	35	M 12	500	95,43
740-040-2	1	40	M 14	660	109,09
740-050-2	1	50	M 14	1.040	133,89

HUSILLO PARA PERFORADOR DE CHAPA 740



- Husillos de repuesto para perforadores de chapa de la serie 740
- Husillo estándar de M8 a M14
- Se vende en kit

R	📦	Ø mm	€
740S-008-2	6	M 8	1,81
740S-010-2	6	M 10	1,92
740S-012-2	6	M 12	3,01
740S-014-2	6	M 14	4,21



11. HERRAMIENTAS DE CORTE Y MEDICIÓN



ARCOS TRONZADORES Y HOJAS

ARCOS TRONZADORES



- Arco tronizador de acero con pintura en polvo
- 802-2400-1 para madera seca
- 802-3000-1 y 802-3600-1 para madera verde y mojada
- Protector incluido

R	Paquete	L (mm)	L (")	T (mm)	T (")	g	oz	€
802-2400-1	5	607	24"	51	675	23.8		8,81
802-3000-1	5	759	30"	23	800	28.2		9,89
802-3600-1	5	912	36"	23	920	32.4		11,32

HOJAS DE TRONZAR, MADERA VERDE



- Ideada para aserrar madera verde y húmeda
- Acero de alta calidad templado
- Envase individual con una protección de dentado para prevenir la oxidación

R	Paquete	L (mm)	L (")	g	oz	€
802-2423-1	10	607	24"	60	2.1	4,58
802-3023-1	10	759	30"	75	2.6	4,29
802-3623-1	10	912	36"	95	3.4	4,77

HOJAS DE TRONZAR, MADERA SECA



- Para aserrar madera seca
- Acero de alta calidad templado
- Envase individual con una protección de dentado para prevenir la oxidación

R	Paquete	L (mm)	L (")	g	oz	€
802-2451-1	10	607	24"	65	2.3	3,72
802-3051-1	10	759	30"	80	2.8	4,29
802-3651-1	10	912	36"	100	3.5	4,77

SERRUCHOS

SERRUCHO UNIVERSAL



- Mango atornillado bicomponente
- Mango útil para hacer guías de 45 y 90°
- Para todo tipo de maderas

R	Paquete	L (mm)	L (")	Teeth	g	€
800-168-1	10	400	16"	8	320	8,23
800-208-1	10	500	20"	8	360	8,66
800-228-1	10	550	22"	8	380	9,10

SERRUCHO DE COSTILLA 12"



- Especialmente adaptado para cortar madera de pequeño diámetro y para utilizar con guía de aserrado
- Mango atornillado de plástico
- Dentado universal, templado para un afilado duradero

R	Paquete	L (mm)	L (")	Teeth	g	€
800-131-1	10	300	12"	15/16	450	14,63



SERRUCHO UNIVERSAL 12"



- Serrucho universal para el corte suave de gran variedad de materiales, incluyendo aluminio, plásticos, laminados, madera y cartón
- Mango atornillado de plástico
- Ideal para transporte en cajas de herramientas
- Dentado de punta dura

					€	
800-151-1	4	300	12"	15/16	225	9,71

SERRUCHO EBANISTA 10"



- Para cortar madera y plástico
- Mango angulado de madera para corte biselado
- Dentado universal, templado para un afilado duradero

					€	
800-111-1	4	250	10"	15/16	240	27,40

SERRUCHO DE CALAR 12"



- Sierra de calar para todo tipo de maderas y plásticos
- Dentado universal templado para un afilado duradero
- Mango atornillado de plástico

					€	
800-141-1	4	300	12"	7/8	120	16,77

ARCO PARA METAL DE ALUMINO

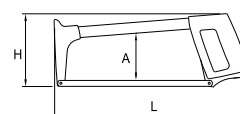
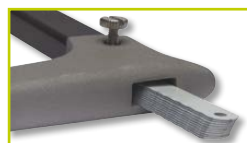

- Arco profesional muy robusto
- Suministrado con la hoja bimetálica de 24 DPP de 30 mm (12")
- Posibilidad de colocar la hoja en 55° para cortar a nivel

					€
801101	5	400 (300)	24	748	21,23

ARCO DE METAL N.4

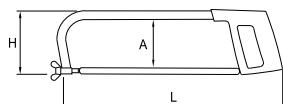
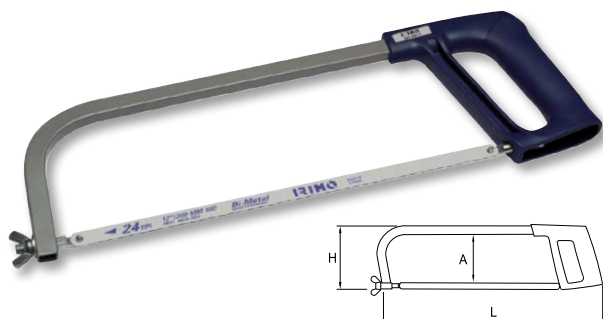

- Arco de sierra profesional y firme
- Ofrece un espacio de almacenaje de las hojas dentro de la parte negra rectangular
- Puede usarse como sierra compás
- Con opción de colocar la hoja a 55° para corte en inglete
- Se suministra con una hoja de sierra bimetálica de 24 DPP

						€
801-041-1	10	110	151	400	665	12,73

HOJA BIMETAL



- Hoja bimetálica inastillable con dentado de precisión para todo tipo de corte en metal
- La hoja bimetálica garantiza el afilado duradero
- Envase:
 - 50: caja de plástico de 50 unidades
 - 5: 5 unidades con agujero para colgar

					€
803-318-5	5	300 x 13 x 0.65	18	17	9,50
803-324-5	5	300 x 13 x 0.65	24	17	9,50
803-332-5	5	300 x 13 x 0.65	32	17	9,50
803-318-50	50	300 x 13 x 0.65	18	17	1,90
803-324-50	50	300 x 13 x 0.65	24	17	1,90
803-332-50	50	300 x 13 x 0.65	32	17	1,90





SERRUCHOS

MINI ARCO DE ALUMINIO



- Un mini arco muy útil para cortar en lugares difíciles
- De muy fácil manejo
- Se suministra con una hoja de sierra de 24 DPP

€		H mm	L mm		g	€
801-145-1	5	51	229	140	13,07	

ARCO DE METAL N.1

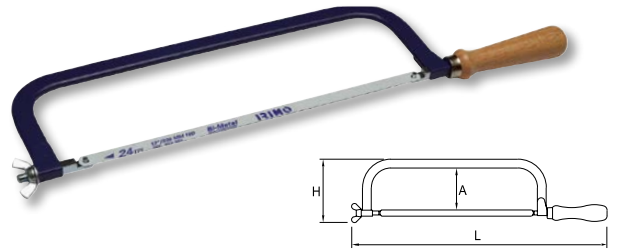

- Arco tradicional, de fácil uso

€		A mm	H mm	L mm		g	€
801-011-1	10	100	128	512	575	13,55	

CORONAS

JUEGO 6 CORONAS BI-METAL



- Juego:
 - 6 coronas bi-metales 22, 29, 35, 44, 51, 64 mm
 - Pequeño soporte
 - 1 broca de repuesto
- Estuche con foam bi-color

€			X		L x W x H		g	€
810-2264-4	1	9			230 x 180 x 70	1.000	66,81	

LIMAS

PLANA PUNTA

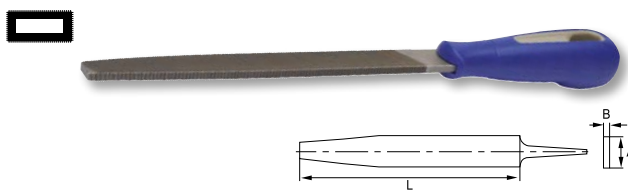

- Plana con punta
- Para limar superficies planas, esquinas, la forma de su punta facilita el acceso en ángulos y esquinas

€		L mm	A mm	B mm				g	€		
<table border="0" style="width:100%"> <tr> <td style="text-align:center"></td> <td>BASTA</td> </tr> </table>											BASTA
	BASTA										
534521	6	150 / 6"	16	4	13	33	90	8,19			
534531	6	200 / 8"	20	5	10	25	160	9,08			
534541	6	250 / 10"	25	5.5	9	23	250	11,60			
534551	6	300 / 12"	30	6	8	20	413	14,50			
<table border="0" style="width:100%"> <tr> <td style="text-align:center"></td> <td>ENTREFINA</td> </tr> </table>											ENTREFINA
	ENTREFINA										
534251	6	150 / 6"	16	4	18	46	50	8,26			
534261	6	200 / 8"	20	5	14	36	160	9,20			

PLANA PARALELA

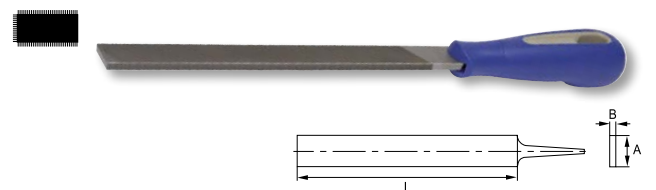

- Plana paralela basta
- Picado de doble superficie, un canto con picado simple, sin picado

€		L mm	A mm	B mm				g	€		
<table border="0" style="width:100%"> <tr> <td style="text-align:center"></td> <td>BASTA</td> </tr> </table>											BASTA
	BASTA										
534561	6	150 / 6"	16	4	13	33	90	8,19			
534571	6	200 / 8"	20	5	10	25	160	9,08			
<table border="0" style="width:100%"> <tr> <td style="text-align:center"></td> <td>ENTREFINA</td> </tr> </table>											ENTREFINA
	ENTREFINA										
534281	6	150 / 6"	16	4	18	46	50	8,26			
534291	6	200 / 8"	20	5	14	36	160	9,20			



MEDIA CAÑA

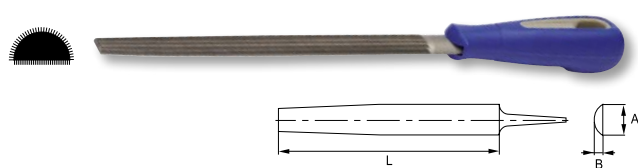

- Para limar superficies planas, cóncavas y grandes agujeros
Ideal para desbastado

🔄	📦	L mm	A mm	B mm	🔧	🔧	📦	€
BASTA								
534681	6	150 / 6"	16	4.7	13	33	100	9,89
534691	6	200 / 8"	20.5	6	10	25	170	11,35
534701	6	250 / 10"	26.5	7.5	9	23	344	15,02
ENTREFINA								
534371	6	150 / 6"	16	4.7	18	46	100	9,89
534381	6	200 / 8"	20.5	6	14	36	170	11,90

REDONDA

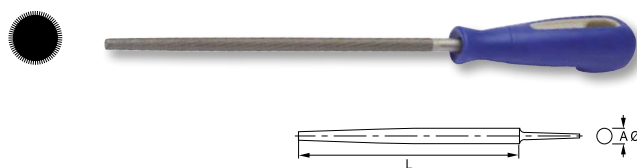

- Para limar agujeros, superficies cóncavas
- Picado de superficies doble

🔄	📦	L mm	A mm	B mm	🔧	🔧	📦	€
BASTA								
534601	6	150 / 6"	16	4.7	13	33	100	6,87
534611	6	200 / 8"	20.5	6	10	25	170	8,31
534621	6	250 / 10"	26.5	7.5	9	23	344	10,56
ENTREFINA								
534311	6	150 / 6"	16	4.7	18	46	100	7,18
534321	6	200 / 8"	20.5	6	14	36	170	8,70

TRIANGULAR

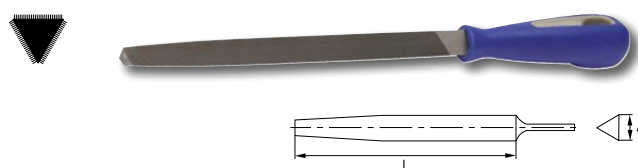

- Para afilado y desbastado en ángulos, esquinas interiores, superficies cóncavas y limados planos
- Picado de superficies doble

🔄	📦	L mm	A mm	🔧	🔧	📦	€
BASTA							
534901	6	150 / 6"	11	13	33	94	7,29
534911	6	200 / 8"	15.5	10	25	203	7,56
ENTREFINA							
534341	6	150 / 6"	11	18	46	94	8,38
534351	6	200 / 8"	15.5	14	36	203	10,90

CUADRADA

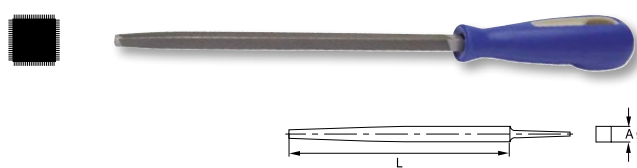

- Para limar ranuras, agujeros cuadrados y rectangulares, esquinas interiores y ajuste fino
- Picado de superficies doble

🔄	📦	L mm	A mm	🔧	🔧	📦	€
BASTA							
534931	6	150 / 6"	6	13	33	79	6,36
534941	6	200 / 8"	8	10	25	132	6,58
ENTREFINA							
534401	6	150 / 6"	6	18	46	79	5,72
534411	6	200 / 8"	8	14	36	132	6,00

JUEGO 6 LIMAS 8"



🔄	📦	📦	📦	📦	€
534501	1	6	44 x 37 x 3	1.150	65,40
534261			534351		
534291			534381		
534321			534411		





NIVELES

NIVEL



* sin asas: 982-40-1
982-4M-1



* con asas: 982-60-1
982-80-1
982-6M-1

- Precisión ± 1 mm/m
- Alta visibilidad
- Tres fiolas tipo barril: Horizontal, vertical, 45°
- Aluminio ligero
- Diseño robusto de perfil. Superficies de apoyo tratadas
- Pintura epoxy de gran durabilidad

€		A mm	B mm	L mm	g	€
982-40-1	1	24	60	400	300	13,25
982-60-1	1	24	60	600	360	16,13
982-80-1	1	24	60	800	550	21,98

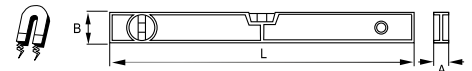

- Dos potentes imanes
- Necesarios 9 Newtons para separarlos entre sí
- Tres fiolas tipo barril: Horizontal, vertical, 45°

€		A mm	B mm	L mm	g	€
982-4M-1	1	22	60	400	280	14,81
982-6M-1	1	24	60	600	370	26,90

NIVEL



NIVEL MAGNÉTICO

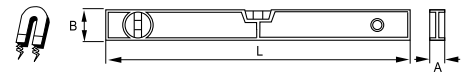
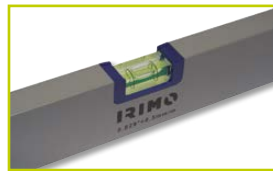
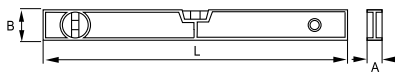

- Perfil de aluminio, ligero, 450 g/m
- Perfil ligero, fácil de transportar, tamaño 20 x 49 mm
- Precisión ± 0,5 mm/m
- Fiolas de gran visibilidad
- Tres fiolas: horizontal, vertical y 45°
- Tapones protectores
- Pintura epoxy de larga duración

€		A mm	B mm	L mm	g	€
981-400-1	1	20	49	400	175	9,97
981-600-1	1	20	49	600	215	12,15
981-800-1	1	20	49	800	275	16,55
981-1000-1	1	20	49	1.000	325	18,63
981-1200-1	1	20	49	1.200	380	20,33
981-1500-1	1	20	49	1.500	480	23,71
981-1800-1	1	20	49	1.800	550	27,96
981-2000-1	1	20	49	2.000	605	29,66

- Perfil de aluminio
- Perfil ligero, fácil de transportar, tamaño 22 x 49 mm
- Precisión ± 0,5 mm/m
- Fiolas de gran visibilidad
- Tres fiolas: horizontal, vertical y 45°
- Incluye dos imanes
- Tapones protectores
- Pintura epoxy de larga duración

€		A mm	B mm	L mm	g	€
981-400M-1	1	22	49	400	300	14,67
981-600M-1	1	22	49	600	450	18,19



JUEGO DE NIVELES, 2 piezas

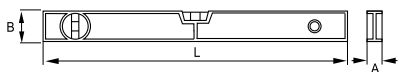

- Juego de dos niveles:
Nivel tubular de 600 mm + torpedo 982-TOR
- Fiolas de alta visibilidad y baja densidad

€		A mm	B mm	L mm	g	€
982-SET	1	55	60	600	410	13,44

JUEGO DE 3 NIVELES DE BURBUJA



- Juego de 3 niveles: 600, 1200 y 2000 mm
- Precisión $\pm 0,5$ mm/m
- Viales de alta visibilidad
- Tres viales: horizontal, vertical y 45°
- Tapas protectoras para los extremos
- Pintura epoxi de larga duración

€				g	€
981-SET	1	3	600 + 1200 + 2000 mm	1.200	63,51

NIVEL "TORPEDO"



- Imán en la base
- Adecuado para fontaneros
- 3 viales: horizontal, vertical y de 45°
- Precisión de ± 1 mm/m en la fiola horizontal
- Precisión de ± 1 mm/m en las fiolas verticales
- Líquido de alta visibilidad en el interior de las fiolas

€		A mm	B mm	L mm	g	€
982-TOR-1	1	15	40	230	80	7,81

NIVEL DE BOLSILLO 100 MM

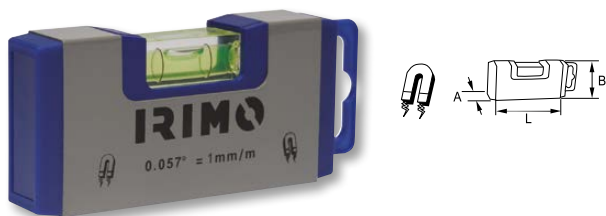

- Tamaño ideal para llevar en el bolsillo, 10 cm
- Precisión: ± 1 mm/m
- Fiola de alta visibilidad
- 2 fuertes imanes en la base que aguantan hasta 500 g

€		A mm	B mm	L mm	g	€
982-10-1	1	20	50	100	60	6,02

JUEGO NIVEL TORPEDO BASE MAGNÉTICA CON ESTUCHE



- Juego de nivel de aluminio con base magnética y estuche nylon para transporte fácil
- Precisión de ± 1 mm/m en todas las fiolas
- 3 fiolas: horizontal, vertical y de 45°
- Pareja de imanes fuertes de neodimio en la base

€			g	€
983-25-1	5	240 x 140 x 25	315	18,05





FLEXÓMETROS

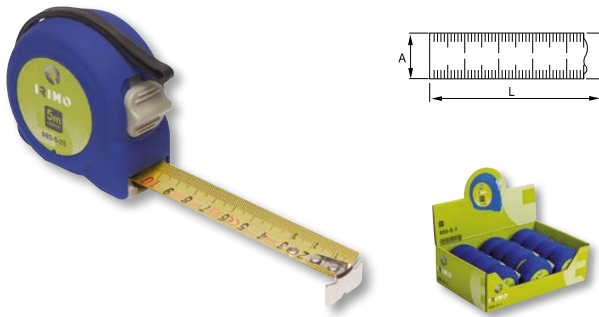

- Clase II de precisión acorde a la normativa UE de instrumentos de medición
- Cuerpo ABS
- Sistema de bloqueo
- Cinta para la muñeca
- Clip trasero para colgar del cinturón
- Hoja de Acero 50C alta calidad

* Suministrado en caja expositora si se piden 12 unidades

R	📦	A mm	L m	g	€
980-3-1	12	16	3	140	3,65
980-5-1	12	19	5	180	5,21
980-5-25-1	12	25	5	175	8,84

- Clase II de precisión acorde a la normativa UE de instrumentos de medición
- Cuerpo ABS con recubrimiento de goma
- Sistema de bloqueo
- Cinta para la muñeca
- Clip trasero para colgar del cinturón
- Hoja de Acero 50C alta calidad

* Suministrado en caja expositora si se piden 12 unidades

R	📦	A mm	L m	g	€
980-3B-1	12	16	3	125	5,69
980-5B-1	12	19	5	195	9,21
980-8B-1	12	25	8	370	17,96

PACK DE 2 FLEXÓMETROS 3 Y 10 M



- Clase II de precisión
- Cinta para la muñeca
- Clip trasero para colgar del cinturón
- Medidas: 3 m x 16 mm, 10 m x 25 mm

R	📦	📦	📦	g	€
980-TP2-1	12	2	170 x 80 x 42	549	17,33

FLEXÓMETROS REFLECTANTES

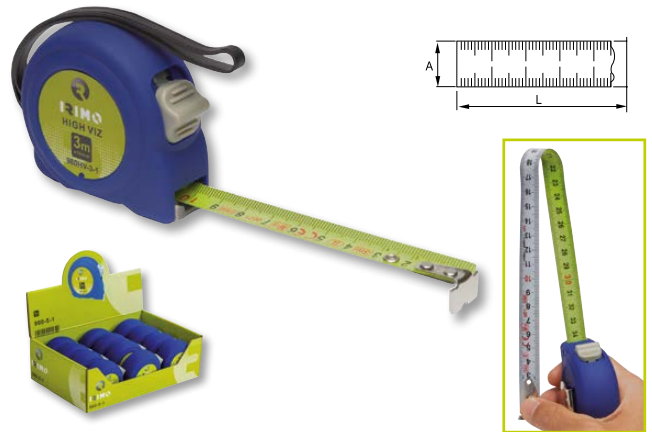

- Cinta de color verde especial para una mayor visibilidad
- Marcado vertical en la parte de posterior: permite una sencilla medición y marcado en vertical
- Cumple con la directiva UE para instrumentos de medición
- Exactitud: Clase II
- Carcasa ABS con recubrimiento de goma
- Instalación de cierre
- Correa para la muñeca
- Clip de metal para el cinturón
- Cinta de alta calidad de nylon de 50C con un recubrimiento resistente a la abrasión
- 3 remaches en el gancho final

* Suministrado en caja expositora si se piden 12 unidades

R	📦	A mm	L m	g	€
980HV-3-1	12	16	3	105	5,88
980HV-5-1	12	19	5	175	8,50



FLEXÓMETROS PARA MEDIR VERTICALMENTE

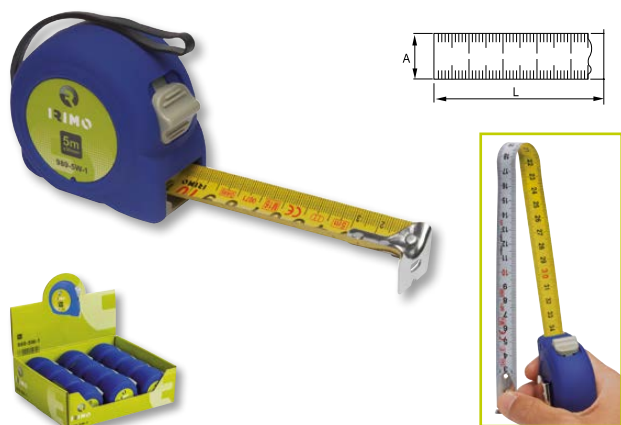

- Cinta de métrica de 5 m x 30 mm de ancho
- Marcado en mm en ambos lados
- Marcado vertical en la parte posterior
- * Suministrado en caja expositora si se piden 12 unidades

R		A mm	L m	g	€
980-5W-1	12	30	5	295	10,04

CINTA MÉTRICA

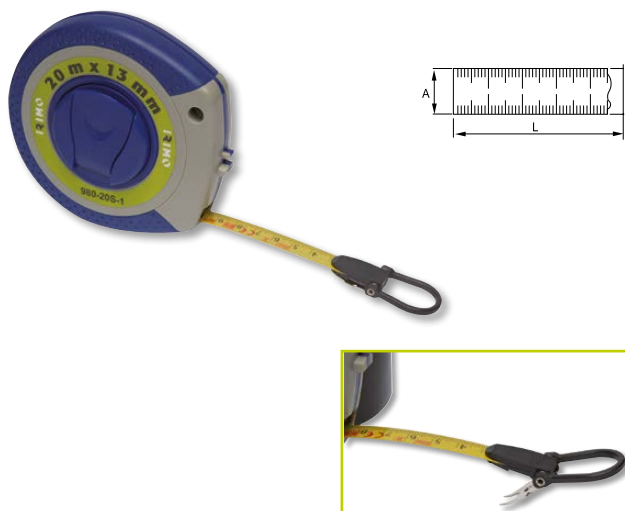

- Clase II de precisión acorde a la normativa UE de instrumentos de medición
- Cuerpo ABS con recubrimiento de goma
- Cinta con anilla en la punta y gancho plegable
- Clip para colgar del cinturón
- Sistema de recogida rápida con manivela
- Hoja de Acero 50C alta calidad
- Caja individual colgable

R		A mm	L m	g	€
980-20S-1	12	13	20	350	14,79

REGLA PLEGABLE DE MADERA



- Regla plegable con 10 hojas de madera
- Madera de abedul, flexible y resistente
- Barniz especial resistente a la abrasión
- Clase II de precisión acorde a la normativa UE de instrumentos de medición

R		A mm	L m	g	€
985-2-1	1	16	2	115	4,10





ESCUADRAS

ESCUADRAS



- Escala en mm
- Hoja de acero inoxidable
- Mango de aluminio

R		L mm	g	€
991-200-1	1	200	230	8,22
991-250-1	1	250	250	9,97
991-300-1	1	300	290	11,74
991-400-1	1	400	330	14,32

ESCUADRAS COMBINADAS



- Escala en mm y pulgadas
- Hoja de acero inoxidable
- Incluye nivel con precisión de 1 mm/m
- Mango de zinc y partes de latón

R		L mm	g	€
993-150-1	1	150	200	11,15
993-300-1	1	300	230	15,85
993-400-1	1	400	260	18,19

GALGAS

GALGAS DE ROSCAS



- Longitud de hoja: 70 mm

R			g	€
972-52-1	25	52 hojas	65	11,76
Métrica 60° - 0,25 a 6 mm 0,25-0,30-0,35-0,40-0,45-0,50-0,60-0,70-0,75-0,80-0,90- 1-1,25-1,50-1,75-2-2,5-3-3,5-4-4,5-5-5,5-6 Whitworth 55° - 4 a 62 hilos" 4-4,5-5-6-7-8-9-10-11-12-13-14-16-18-19-20-22-24-25- 26-28-30-32-36-40-48-60-62				

GALGAS DE ESPESORES



- Longitud de hoja: 100 mm

R			g	€
971-13-1	5	13 hojas	52	7,95
0,05 a 1 mm 0,05-0,10-0,15-0,20-0,25-0,30-0,40-0,50-0,60-0,70- 0,80-0,90-1				
971-20-1	5	20 hojas	83	10,51
0,05 a 1 mm 0,05-0,10-0,15-0,20-0,25-0,30-0,35-0,40-0,45-0,50-0,55- 0,60-0,65-0,70-0,75-0,80-0,85-0,90-0,95-1				



CALIBRES

CALIBRE VERNIER 150 MM



- Calibre vernier
- Precisión $\pm 0,03$ mm
- Fabricado en acero inoxidable endurecido
- Incluye caja de plástico para un almacenamiento seguro

984-6-1	1	0-150	0-6"	235	25 x 90 x 245	150	29,22

CALIBRE DIGITAL ACERO INOXIDABLE 150 MM



- Calibre vernier digital
- Precisión $\pm 0,03$ mm
- Fabricado en acero inoxidable endurecido
- Incluye caja de plástico para un almacenamiento seguro

984-6D-1	1	0-150	0-6"	235	25 x 90 x 245	150	40,85

TERMÓMETRO INFRARROJOS



- Medición de temperatura sin contacto
- Rango de medición: -50° a 420° (-58°F a 788°F)
- Con puntero laser
- Precisión: 0° a 420° , $\pm 1.5^{\circ}$
 -50° a 0° , $\pm 3^{\circ}$
- Resolución: 0.1°
- Repetibilidad: 1% de lectura o 1°
- Tiempo de respuesta: 500 ms
- Ratio de medición: L12 to D1
- Batería de 9V no incluida

LT-420-1	1	155	170	41,08





ESPÁTULAS

ESPÁTULAS

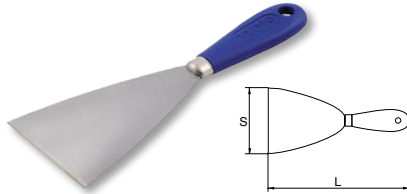

- Hoja templada de 1,5 mm de grosor / 0,5 mm en el filo
- Excelente flexibilidad
- Pulida y barnizada de larga durabilidad
- Virola metálica para la perfecta unión entre hoja y mango
- Mango de plástico con agujero para colgar
- DIN 7216, UNE 16608

€		S mm	L mm		€
540021	12	20	220	50	3,13
540031	12	30	220	55	3,15
540041	12	40	220	60	3,27
540051	12	50	220	65	3,39
540061	12	60	220	70	3,49
540071	12	70	220	75	3,76
540081	12	80	220	80	3,97
540091	12	90	220	85	4,26
540101	12	100	220	90	4,77
540121	12	120	220	100	5,59

JUEGO DE ESPÁTULAS DE CARROCERO



- Juego de espátulas de carrocero, 4 piezas
- Cuchilla de acero al carbono
- Excelente flexibilidad y máxima durabilidad
- Cuchilla pulida y barnizada para evitar la oxidación
- Se suministra en una bolsa de plástico

€					€
536011	1	4	160x130	120	15,91

90x50 mm, 120x80 mm, 120x105 mm, 120x120 mm

HERRAMIENTAS DE APRIETE

PISTOLA DE SILICONA

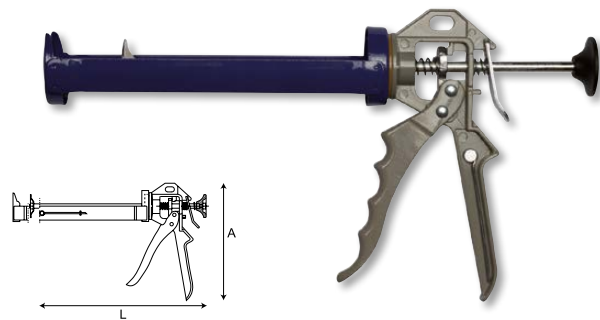

- Pistola de silicona para cartuchos de 9"
- Idónea para mayoría de resinas y siliconas
- Asa y gatillo fabricado en aluminio
- Cuerpo giratorio para facilitar la carga del cartucho
- Aguja incorporada
- Ratio de descarga 7:1
- Fuerza máxima de empuje 1500N

€		A mm	L mm		€
549-230-2	1	200	330	550	8,23

PISTOLA DE COLA TERMOFUSIBLE



- Con interruptor On-Off para ahorro de energía
- Normativa CE/GS
- Boquilla protectora para mayor durabilidad y seguridad
- Incluye dos boquillas adicionales y una válvula de seguridad para prevenir goteos involuntarios
- Gacho plegable para mantener la pistola en reposo
- Potencia de 80W; Voltaje 220-240V; Precalentamiento 3-5 minutos; Flujo de encolado 14-15 g por minuto. Cable de 1,6 m
- Contiene 12 barras de cola 11,2x150 mm (6 uso general, 6 cola extrafuerte)
- Embalaje en blíster

€				€
550-80-4	1	40x190x190	250	29,36



PISTOLA DE CALOR 2000W



- Pistola de calor temperatura regulable 2000W
- Pantalla led para ajuste de temperatura
- 12 valores de ajuste de temperatura
- 2 opciones de flujo de aire diferentes:
 - Velocidad 1: 250 l/min - 50 °C, 100 °C, 150 °C, 200 °C, 250 °C, 350 °C
 - Velocidad 2: 550 l/min - 100 °C, 200 °C, 300 °C, 400 °C, 500 °C, 600 °C
- Sistema de enfriamiento automático: 280 l/min - 50 °C
- Modo manos libres

€				€
551-HG-1	1	200 x 65 x 240	560	60,00

BOQUILLAS PARA PISTOLA DE CALOR



- 4x boquillas de pistola de calor
- Cuatro boquillas diferentes, una para cada tipo de trabajo
- Compatible con pistola de calor 551-HG-1

€					€
551-NOZ-1	1	4	5 x 110 x 150	10	3,90

GRAPADORA 4 EN 1



- Kit con quitagrapas que incluye una caja con 1000 grapas
- Grapadora compacta y polivalente
- Ajuste de potencia alto-bajo para controlar la intensidad de la aplicación
- La ventana de grapas proporciona una clara visibilidad para determinar cuándo es necesario recargar las grapas
- Mecanismo anti-atasco para un uso continuo y un funcionamiento fiable
- Agarre con bloqueo para un almacenamiento y transporte seguros
- Clip para el cinturón

€				€
560-41LP-1	3	170x290x40	690	22,44

GRAPADORA MARTILLO



- Kit con caja de 1000 grapas
- Grapadora martillo compacta con carcasa de acero
- Mecanismo anti-atasco para un uso continuo y un funcionamiento fiable
- Mango ergonómico para un mejor agarre y manejo

€				€
560-HTS-1	6	115x350x32	520	12,65





HERRAMIENTAS DE APRIETE

GRAPADORA 4 EN 1



- Grapadora compacta y polivalente
- Ajuste de potencia alto-bajo para controlar la intensidad de la aplicación
- La ventana de grapas proporciona una clara visibilidad para determinar cuándo es necesario recargar las grapas
- Mecanismo anti-atasco para un uso continuo y un funcionamiento fiable
- Agarre con bloqueo para un almacenamiento y transporte seguros
- Clip para el cinturón
- Compatible con:
 - Grapas heavy duty (1,2): 6-14 mm (1/4"-9/16")
 - Grapas ligeras (0,7): 6-14 mm (1/4"-9/16")
 - Grapas para cables: 10-14 mm (3/8"-9/16")
 - Clavos tipo clavo 18: 15 mm (19/32")

€	Icono	A mm	B mm	C mm	Icono	g	€
560-41-1	3	170	290	40	690	19,83	

GRAPAS HEAVY DUTY



- Para trabajos pesados de grapado como el aislamiento, alfombras o tela asfáltica
- Para tejidos, telas, alfombras, cartón, listones planos de madera, madera, cartón y malla metálica

€	Icono	A mm	B mm	C mm	Icono	g	€
560-HD-06	12	1.2	11.3	6	40x28x80	110	2,36
560-HD-08	12	1.2	11.3	8	65x35x80	137	2,60
560-HD-10	12	1.2	11.3	10	65x35x80	158	2,69
560-HD-12	12	1.2	11.3	12	65x35x80	172	2,82
560-HD-14	12	1.2	11.3	14	65x35x80	195	2,94

GRAPAS TIPO CLAVO 15 MM



- Para trabajos de artesanía y carpintería

€	Icono	A mm	B mm	C mm	Icono	g	€
560-BN-15	12	1.2	2	15	40x28x80	122	1,93

GRAPADORA MARTILLO



- Grapadora martillo compacta con carcasa de acero
- Mecanismo anti-atasco para un uso continuo y un funcionamiento fiable
- Mango ergonómico para un mejor agarre y manejo

€	Icono	A mm	B mm	C mm	Icono	g	€
560-HT-1	6	115	350	32	520	12,12	

GRAPAS



- Para trabajos domésticos ligeros y manualidades

€	Icono	A mm	B mm	C mm	Icono	g	€
560-LD-06	12	0.7	11.3	6	40x28x80	70	1,77
560-LD-08	12	0.7	11.3	8	65x35x80	88	1,99
560-LD-10	12	0.7	11.3	10	65x35x80	102	2,02
560-LD-12	12	0.7	11.3	12	65x35x80	112	2,11
560-LD-14	12	0.7	11.3	14	65x35x80	117	2,17

GRAPAS PARA CABLES



- Para cables de bajo voltaje

€	Icono	A mm	B mm	C mm	Icono	g	€
560-CA-10	12	1.2	7.5	10	65x35x80	127	2,69
560-CA-12	12	1.2	7.5	12	65x35x80	145	2,82
560-CA-14	12	1.2	7.5	14	65x35x80	151	2,94



12. ILUMINACIÓN Y HERRAMIENTAS NEUMÁTICAS Y A BATERÍA



LÁMPARAS DE BOLSILLO

LÁMPARA FLEXIBLE



- LED COB (principal) / 1xSMD (linterna)
- LUMENS: 400 lm (principal) / 70 lm (linterna)
- Batería:
 - Material: Litio 3.7V 2000mAh
 - Tiempo de funcionamiento: 3 h (principal) / 10 h (linterna)
 - Tiempo de carga: 3 h
 - Puerto de carga: Micro USB
- Dos opciones de intensidad de luz
- Incluye un cable micro USB de 1 m
- Temperatura: 5700 K
- CRI: >70
- IP54 / IK07
- CE-EMC / RoHS / Reach

L-FLEX-1	1	400	70	✓	3/10	3.5	74 x 262 x 45	307	55,36

LÁMPARA COMPACTA



- LED COB (principal) / 1xSMD (linterna)
- LUMENS: 600 lm (principal) / 100 lm (linterna)
- Batería:
 - Material: Litio 3.7V 2000mAh
 - Tiempo de funcionamiento: 2,5 h (principal) 6 h (linterna)
 - Tiempo de carga: 3 h
 - Puerto de carga: Micro USB
- Incluye un cable micro USB de 1 m
- Temperatura: 5700 K
- CRI: >80
- IP54 / IK07
- CE-EMC / RoHS / Reach

L-COMP-1	1	600	100	✓	2.5/6	3	75 x 207 x 38	223	47,42

DELGADA FLEX



- LED COB (principal) / 1xSMD (linterna)
- LUMENS: 400 lm (principal) / 70 lm (linterna)
- Batería:
 - Material: Litio 3.7V 2000mAh
 - Tiempo de funcionamiento: 3-8 h (principal) 8 h (linterna)
 - Tiempo de carga: 3 h
 - Puerto de carga: Micro USB
- Regulador de intensidad de la luz mediante rueda con el pulgar
- Incluye un cable micro USB de 1 m
- Temperatura: 5700 K
- CRI: >70
- IP20 / IK07
- CE-EMC / RoHS / Reach

L-SLIM-1	1	400	70	✓	3/8	3	82 x 168 x 36	200	50,82



MINI LÁMPARA FLEXIBLE



- LED SMD 4+1
- LUMENS: 250 lm (principal) / 70 lm (linterna)
- Batería:
 - Material: Litio 3.7V 1000mAh
 - Tiempo de funcionamiento: 3 h (principal) 7 h (linterna)
 - Tiempo de carga: 3 h
 - Puerto de carga: Micro USB
- Incluye un cable micro USB de 1 m
- Temperatura: 5700 K
- CRI: >80
- IP20 / IK07
- CE-EMC / RoHS / Reach

Icono	Q	Paquete	lm	lm	h	h	Paquete	g	€
L-MINI-1	1	250	70	✓	3/7	3	53 x 195 x 53	130	32,74

LÁMPARA FLEXIBLE DE BOLSILLO



- LED SMD 4+1
- LUMENS: 250 lm (principal) / 70 lm (linterna)
- Batería:
 - Material: Litio 3.7V 1000mAh
 - Tiempo de funcionamiento: 2-2,5 h (principal) 6 h (linterna)
 - Tiempo de carga: 3 h
 - Puerto de carga: Micro USB
- Incluye un cable micro USB de 1 m
- Temperatura: 5700 K
- CRI: >80
- IP20 / IK07
- CE-EMC / RoHS / Reach

Icono	Q	Paquete	lm	lm	h	h	Paquete	g	€
L-POCK-1	1	250	70	✓	2,5/6	3	73 x 138 x 45	220	30,49

LÁMPARAS DE INSPECCIÓN

LINTERNA DE ALUMINIO



- LED COB
- LUMENS: 100 lm
- Batería:
 - 3AAA incluidas
 - Tiempo de funcionamiento: 9 h
- Cuerpo de aluminio
- Botón de goma de fácil apriete
- Correa para colgarlo
- Temperatura: 6500 K
- CRI: >70
- IP44
- CE-EMC / RoHS

Icono	Q	Paquete	lm	Batería	Paquete	g	€
L-ALUM-1	1	100	3AAA	100 x 45 x 35	100	5,08	
L-ALUM-12DISP	1			105 x 220 x 170	1.050	60,98	

LÁMPARA TIPO BOLI



- LED SMD 6+1
- LUMENS: 150 lm (principal) / 70 lm (linterna)
- Batería:
 - Material: Litio 3.7V 600mAh
 - Tiempo de funcionamiento: 2,5 h (principal) 3,5 h (linterna)
 - Tiempo de carga: 2 h
 - Puerto de carga: USB tipo C
- Incluye un cable micro USB de 1 m
- Temperatura: 5700 K
- CRI: >80
- IP20 / IK07
- CE-EMC / RoHS / Reach

Icono	Q	Paquete	lm	lm	h	h	Paquete	g	€
L-PEN-1	1	150	70	✓	2,5/3,5	2	39 x 164 x 18	390	21,45





LÁMPARAS DE TRABAJO

LÁMPARA DE TRABAJO



- LED 27xSMD
- Dos opciones de intensidad
- LUMENS: 500 lm / 1000 lm
- Batería:
 - Material: Litio 3.7V 4000mAh
 - Tiempo de funcionamiento: 6 h / 500 lm, 3 h / 1000 lm
 - Tiempo de carga: 2,5-3 h / 5V 2A
 - Puerto de carga: Micro USB
- Funcionalidad de depósito de energía
- Mango giratorio 270°
- Incluye un cable micro USB de 1 m
- Temperatura: 6000 K
- CRI: >80
- IP54 / IK08
- CE-EMC / RoHS / Reach

L-BOOK-1	1	500/1000	3/6	3	182 x 142 x 52	400	50,82

LÁMPARAS FRONTALES

HEAD LIGHT



- LED SMD
- LUMENS: 400 lm
- Batería:
 - Material: Litio 3.7V 2200mAh
 - Tiempo de funcionamiento: 5 h
 - Tiempo de carga: 4 h
 - Puerto de carga: Micro USB
- Dos opciones de intensidad y parpadeo en el frente
- Luz roja trasera con opción de parpadeo
- Correa ajustable
- Cabeza giratoria
- Zoom para un mejor enfoque
- Incluye un cable micro USB de 1 m
- Temperatura: 6000 K
- CRI: >70
- IP44
- CE-EMC / RoHS / Reach



L-HEAD-1	1	5	4	118 x 87 x 64	125	28,23



LLAVE IMPACTO 3/8"

P704

MAX
Nm 150



LLAVE IMPACTO 3/4"

P817

kg 3.95



LLAVE IMPACTO 1/2"

P800

MAX
Nm 600



P815

MAX
Nm 825



- Fabricadas en composite con especial énfasis en su ligereza y escasa vibración

IRIMO	Paquete	BAR	inches	mm	mm	Nm	MAX Nm	rpm	mm	kg	€				
P704	1	3/8"	6.3	1/4" - 18	10	127	55 - 120	150	10.000	1.200	89.00	5.92	160	0.90	89,08
P800	1	1/2"	6.3	1/4" - 18	10	99	100 - 570	600	7.500	1.300	90.00	2.57	192	2.40	154,22
P815	1	1/2"	6.3	1/4" - 18	10	130	320 - 620	825	7.000	1.150	84.00	5.00	192	1.95	187,27
P817	1	3/4"	6.3	3/8" - 18	10	190	340 - 950	1.800	4.500	970	88.00	4.30	245	3.95	479,20

LLAVE IMPACTO 1"

MAX
Nm 2.500

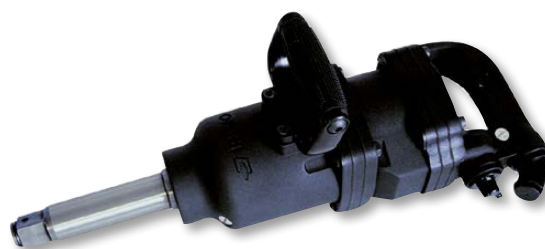

- Eje largo 6" - 150 mm
- Ideal para camiones

IRIMO	Paquete	BAR	inches	mm	mm	Nm	MAX Nm	rpm	mm	kg	€				
P802	1	1"	6.3	1/2" - 14	13	416	950 - 2.030	2.500	3.800	500	98.00	<2.50	550	14.40	688,22





CARRACA 1/4"

P700

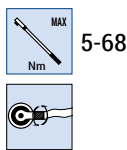

Q	Box	BAR	inch	mm	mm	Nm	mm	dB	mm	kg	€		
P700	1	1/4"	6.3	1/4" - 18	10	136	0 - 27	300	94.00	3.60	133	0.50	159,01
P821	1	1/2"	6.3	1/4" - 18	10	120	0 - 67	150	80.00	2.60	256	1.20	198,78

CARRACA 1/2"

P821



• Composite

SOPLADORA



Q	Box	BAR	kg	€
P218	1	6.3	135	10,40

CONECTORES RÁPIDOS



PM5002
PM5003



PM5012
PM5013



PM5142
PM5143



PM5152
PM5153



PM5248

Q	Box	inch	mm	g	€
PM5002 PM5003	1	1/4" 3/8"	Macho Macho	70	5,09 4,87
PM5012 PM5013	1	1/4" 3/8"	Hembra Hembra	80	5,24 9,80
PM5142 PM5143	1	1/4" 3/8"	Macho Macho	20	1,88 1,52
PM5152 PM5153	1	1/4" 3/8"	Hembra Hembra	20	0,99 1,52
PM5248	1	-	Para tubos de 8 mm	10	1,71

CONECTOR AUTOMÁTICO HEMBRA 1/4"



- Multi-perfil para una mayor flexibilidad y polivalencia, compatible con los cuatro conectores macho (ISO6150B, ARO210, Europe/Alemán & Italiano)
- Cierre de seguridad que proporciona al usuario la posibilidad de cerrar el flujo de aire
- Mayor seguridad. No se puede desacoplar a menos que se cierre el aire
- Operación simplificada. Facilita la conexión a la herramienta ya que se hace sin luchar contra la presión de aire
- Gran duración y resistencia gracias a su construcción de núcleo de acero con cobertura de composite

Q	Box	BAR	inch	kg	€	
PQC14	10	1.600	14	1/4"	0.100	26,86

LUBRICADOR



- Instalar en la máquina o en tubo con conector rápido con rosca de 1/4"

Q	Box	inch	kg	€
PN251	1	1/4"	0.10	13,04



REGULADORES - FILTROS



- Cuando se comprime el aire atmosférico, que siempre contiene cierta humedad, se genera agua en el circuito neumático. Por ello, es necesario filtrar esta agua para proteger el propio circuito y, sobre todo, las máquinas neumáticas
- Usar regulador y filtro de aire para pistolas de pintura
- Datos técnicos:
 - Conexión de aire 1/2"
 - Capacidad cubeta 100 ml
 - Ø del manómetro 50 mm
 - Gama de regulación 0,5-10 bar
 - Temp. mínima +5°
 - Temp. máxima 60°
 - Caudal nominal 3.200 NL/mn
 - Filtrado 20 m

R		kg	€
P254	1	1.04	46,30

REGULADORES - FILTROS - LUBRICADORES



- Cuando se comprime el aire atmosférico, que siempre contiene cierta humedad, se genera agua en el circuito neumático. Por ello, es necesario filtrar esta agua para proteger el propio circuito y, sobre todo, las máquinas neumáticas
- Para el resto de máquinas neumáticas, usar regulador, filtro y lubricador
- Datos técnicos:
 - Conexión de aire 1/2"
 - Capacidad cubeta 100 ml
 - Ø del manómetro 50 mm
 - Gama de regulación 0,5-10 bar
 - Temp. mínima +5°
 - Temp. máxima 60°
 - Caudal nominal 3.200 NL/mn
 - Filtrado 20 m

R		kg	€
P255	1	1.42	77,68

ATORNILLADOR A BATERÍA

ATORNILLADOR 1/4" A BATERÍA



- Batería recargable de Litio 3.6V
- Porta puntas cambio rápido 1/4"
- Apriete suave ajustable 6 posiciones+1 reverso
- Tiempo de carga. 3-5 horas
- Indicador de carga LED
- 4 puntas 1/4" incluidas
- 200 rpm
- Par máximo 3,0 Nm
- Embalaje en caja de cartón

R		V	g	RPM	g	€
3.6SDR	1	3.6	95x65x35	200	400	44,20



Estas son algunas de las ventajas de las que podrá disfrutar con nuestro material para el punto de venta:

- Los expositores IRIMO son una perfecta solución que contribuye a mejorar la gestión en el punto de venta.
- Gracias a su atractivo diseño, ayudan a potenciar la imagen del resto de la tienda.
- Facilitan el control del stock y a la par optimizan el espacio de exposición.

NOTA: A continuación se exponen algunos ejemplos; para más información acerca de diferentes accesorios y tamaños, no dude en consultarnos y le ofreceremos la solución ideal y ajustada a sus necesidades.

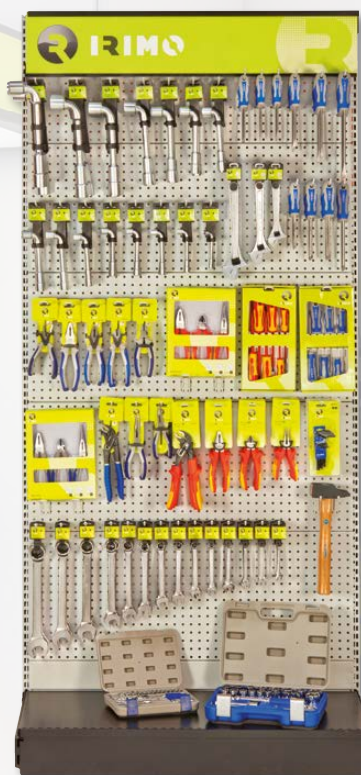

		€
MEE-SIGN-CARR-I	CABECERO IRIMO (100 cm)	-
MEE-1S2L-B-I	EXPOSITOR 2 PATAS	-

* Herramienta no incluida

MATERIAL DE PUNTO DE VENTA

EXPOSITOR 2 PATAS

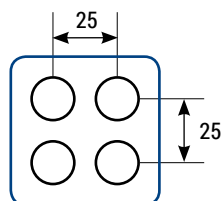
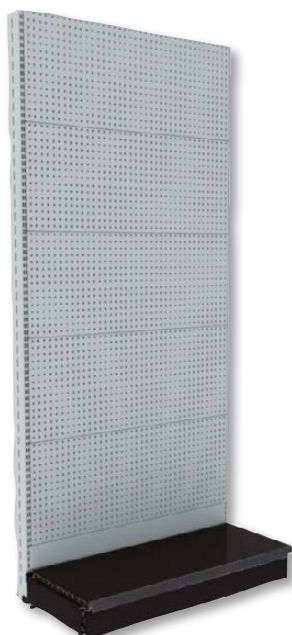

Detalle pared perforada

€	W mm	H mm	L mm	kg	€
MEE-1S2L-B-I	524	2250	1030	53.63	-

CABECERO LUMINOSO



- Cable corto incluido
- Cable largo a pedir a parte (PEE-LCABLE-B-I)

€	W mm	H mm	L mm	kg	€
MEE-LIGHTBOX-I	412	170	1000	13.32	-

CABECERO



€	W mm	H mm	L mm	kg	€
MEE-SIGN-CARR-I	90	200	1000	1.98	-

EXPOSITOR DE ESQUINA 1 PATA

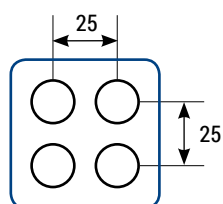
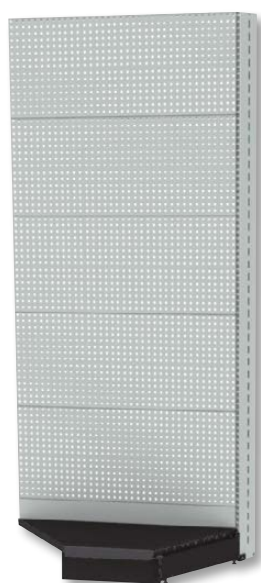

Detalle pared perforada

€	W mm	H mm	L mm	kg	€
MEE-COR-1L-B-I	388	2350	941	44.05	-

CABECERO LUMINOSO ESQUINA



- Cable corto incluido
- Cable largo a pedir a parte (PEE-LCABLE-B-I)

€	W mm	H mm	L mm	kg	€
MEE-COR-LIGHT-I	400	174	910	7.375	-

MATERIAL DE PUNTO DE VENTA

PIEZAS PARA EXPOSITOR DE PARED

METACRILATO PARA CABECERO LUMINOSO



€	W mm	H mm	L mm	kg	€
PEE-METHACRYL-I	3	168	980	0.61	-

METACRILATO PARA CABECERO



€	W mm	H mm	L mm	kg	€
PEE-SIGN-DB-W-2	3	150	980	0.2	-

METACRILATO PARA EXPOSITOR PARED DOBLE



€	W mm	H mm	L mm	kg	€
PEE-TOPSIGN-I	3	150	980	0.2	-

EXPOSITOR DOBLE PARED CON RUEDAS

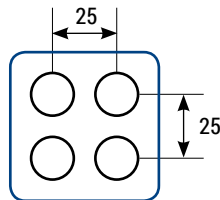
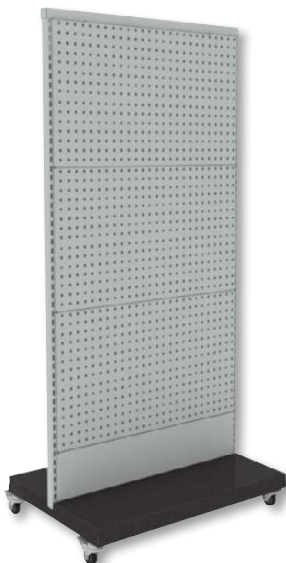

Detalle pared perforada

€	W mm	H mm	L mm	kg	€
MEE-DB-W-NL	300	800	1390	29.99	-

BANNER PARA EXPOSITOR DE PARED



€	W mm	H mm	L mm	kg	€
MEE-BANNER-I	15	1200	230	1.025	-

EXPOSITOR TRIANGULAR CON RUEDAS

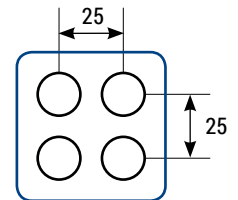
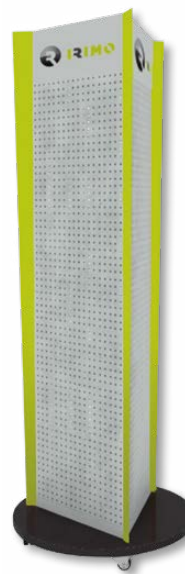

Detalle pared perforada

€	W mm	H mm	L mm	kg	€
MEE-TR-W-I	700	1860	700	23.45	-

MATERIAL DE PUNTO DE VENTA

EXPOSITOR GENÉRICO



IRIMO	W mm	H mm	L mm	kg	€
MEE-COUNT-IR-1	295	615	430	6.7	-

EXPOSITOR GENÉRICO



- El expositor incluye 12 ganchos de 240 mm cada uno

IRIMO	W mm	H mm	L mm	kg	€
MEE-COUNT-IR-2	260	465	465	2.6	-

EXPOSITOR GENÉRICO



- El expositor incluye 22 ganchos de 240 mm cada uno

IRIMO	W mm	H mm	L mm	kg	€
MEE-COUNT-IR-3	270	465	775	4.12	-

CUBRE PALET PARA EURO PALET



IRIMO	W mm	H mm	L mm	kg	€
PEE-PC-IR-1	1150	250	800	0.735	-

DISPLAY PARA ALICATES, 20 piezas



IRIMO	W mm	H mm	L mm	kg	€
PEE-COUNT-006	280	240	365	0.23	-

DISPLAY CARTÓN 5 ALICATES



IRIMO	W mm	H mm	L mm	kg	€
CEE-COUNT-IR-1	200	60	90	0.237	-

HOJA A4 CON PEGATINAS



IRIMO	W mm	L mm	kg	€
PPOS-A4-STICK-1	210	295	0.018	-

EXPOSITOR



- Material: Metal y plástico
- Color: Negro y verde
- Con tres baldas para distintos tamaños de juegos de vasos:
 - Pequeños: 109-35-4
 - Medianos: 119-18-4 o 129-23-4
 - Grandes: 129-58-4 o 129-101-4
- Se entrega vacío

IRIMO	W mm	H mm	L mm	kg	€
MEE-SA-SS-IR	1	1835	455x380	-	-

€	📖	€
001021	36	26,60
001031	36	30,33
001041	36	35,99
001051	36	45,99
001061	36	76,97
001071	36	146,30
001081	36	285,87
020011	44	7,73
020031	44	7,99
020051	44	8,88
020071	44	9,70
020091	44	10,64
020121	44	11,43
020141	44	11,89
020171	44	13,73
020181	44	15,03
020201	44	16,87
020211	44	16,87
020221	44	19,06
020241	44	22,78
020251	44	24,04
021221	44	88,79
021251	44	163,68
040001	112	0,45
040011	112	0,46
040021	112	0,54
040031	112	0,60
040041	112	0,73
040051	112	0,85
040061	112	1,02
040071	112	1,39
040081	112	1,91
040091	112	2,11
040101	112	2,67
040121	112	3,91
040141	112	5,26
040171	112	7,43
040191	112	12,56
040221	112	18,58
040541	112	0,50
040561	112	0,65
040581	112	0,73
040601	112	1,06
040611	112	1,29
040621	112	1,57
040641	112	1,96
040661	112	2,74
040681	112	3,35
040701	112	4,09
040731	112	6,87
041011	112	6,95
041021	112	15,24
041031	112	41,86
041041	112	8,53
041051	112	20,67
041061	112	44,52
041071	112	11,60
041091	112	20,43
041101	112	65,54
041111	113	9,46
041121	113	13,80

€	📖	€
045001	113	0,45
045011	113-115	0,45
045021	113	0,51
045031	113	0,60
045041	113-115	0,61
045051	113	0,89
045061	113	1,08
045071	113	1,48
045081	113	1,68
045091	113	2,27
045101	113	2,36
045121	113	3,48
045141	113	4,89
045171	113	7,83
045191	113-115	11,02
045221	113	17,63
045541	115	0,46
045561	115	0,39
045581	115	0,46
045601	115	0,64
045611	115	0,87
045621	115	1,42
045641	115	1,70
045661	115	2,34
045681	115	2,95
045701	115	3,59
045731	115	6,05
045801	115	0,50
045811	115	0,52
045821	115	0,56
045831	115	0,70
045841	115	0,81
045851	115	1,02
045861	115	1,72
045871	115	2,55
045881	115	2,96
045891	115	3,72
045901	115	4,31
045921	115	6,29
045941	115	8,05
046011	114	6,00
046021	114	14,68
046031	114	38,62
046041	115	7,85
046051	115	18,69
046061	115	39,99
046091	114	18,04
046101	114	60,82
047001	116	1,19
047011	116	1,36
047021	116	1,42
047031	116	1,48
047041	116	1,76
047051	116	2,14
047061	116	3,27
047081	116	4,60
047101	116	8,26
047121	116	8,83
055011	47	11,14
055031	47	11,26
055051	47	12,03

€	📖	€
055071	47	14,13
055091	47	15,90
055121	47	18,72
055141	47	22,02
055171	47	25,09
055181	47	27,88
055201	47	29,78
055211	47	30,29
055221	47	34,37
055241	47	39,20
055251	47	43,68
055301	47	9,62
055311	47	13,43
056231	47	134,95
056271	47	272,41
066-400-1	167	33,47
070411	52	144,49
070421	52	144,49
070431	52	149,48
070441	52	156,95
070451	52	171,91
070461	52	179,36
070471	52	623,98
070481	52	1.243,51
10-0405-1	37	2,70
10-0607-1	37	2,70
10-0809-1	37	2,76
10-1011-1	37	2,99
10-1013-1	37	3,64
10-12-H	38	65,85
10-12-W	38	69,68
10-1213-1	37	3,66
10-1415-1	37	3,87
10-1617-1	37	4,48
10-1719-1	37	5,05
10-1819-1	37	5,05
10-2022-1	37	5,93
10-2123-1	37	6,47
10-2224-1	37	6,52
10-2426-1	37	7,99
10-2427-1	37	8,59
10-2528-1	37	10,91
10-2729-1	37	11,83
10-3032-1	37	13,01
10-8-H	38	31,69
101-04-1	56	3,45
101-045-1	56	3,45
101-05-1	56	3,45
101-055-1	56	3,45
101-06-1	56	3,45
101-07-1	56	3,45
101-08-1	56	3,45
101-09-1	56	3,45
101-10-1	56	3,45
101-11-1	56	3,45
101-12-1	56	3,45
101-13-1	56	3,45
101-14-1	56	3,45
101A-05-1	56	3,51
101A-06-1	56	3,51
101A-07-1	56	3,51

🔍	📖	€
101A-08-1	56	3,51
101A-09-1	56	3,51
101A-10-1	56	3,51
101A-11-1	56	3,51
101A-12-1	56	3,51
101A-14-1	56	3,51
101A-16-1	56	3,51
101A-18-1	56	3,51
103-04-1	56	8,13
103-045-1	56	8,13
103-05-1	56	8,13
103-055-1	56	8,13
103-06-1	56	8,13
103-07-1	56	8,13
103-08-1	56	8,13
103-09-1	56	8,13
103-10-1	56	8,13
103-11-1	56	8,13
103-12-1	56	8,13
103-13-1	56	8,13
103-14-1	56	8,13
103A-06-1	56	8,28
103A-08-1	56	8,28
103A-09-1	56	8,28
103A-10-1	56	8,28
103A-11-1	56	8,28
103A-12-1	56	8,28
103A-14-1	56	8,28
103A-16-1	56	8,28
105-22-1	59	3,90
105-24-1	59	5,30
105-26-1	59	5,60
105-28-1	59	8,87
105-40-1	59	10,01
105-42-1	59	6,85
105-46-1	59	5,30
105-48-1	59	4,12
105-50-1	59	7,78
105-70-1	58	12,40
105-70-12DISP	58	148,77
105501	58	30,74
106-04-1	56	3,68
106-05-1	56	3,68
106-06-1	56	3,68
106-07-1	56	3,68
106-08-1	56	3,68
106-10-1	56	3,68
107-0840-1	57	3,13
107-1055-1	57	3,13
107-1280-1	57	3,13
107-H3-1	57	3,00
107-H4-1	57	3,00
107-H5-1	57	3,00
107-H6-1	57	3,00
107-H8-1	57	3,00
107-PH1-1	57	3,27
107-PH2-1	57	3,27
107-PH3-1	57	3,27
107-PZ1-1	57	3,27
107-PZ2-1	57	3,27
107-PZ3-1	57	3,27

🔍	📖	€
107-T08-1	57	3,89
107-T09-1	57	3,89
107-T10-1	57	3,89
107-T15-1	57	3,89
107-T20-1	57	3,89
107-T25-1	57	4,01
107-T27-1	57	4,01
107-T30-1	57	4,01
107-T40-1	57	4,01
107A-4-1	57	3,04
107A-5-1	57	3,04
107A-6-1	57	3,04
107A-7-1	57	3,04
109-11-4	58	40,08
109-13-4	58	30,36
109-19-4	61	36,03
109-23-4	60	30,28
109-35-4	60	36,84
109-37-4	60	35,00
112-06-1	61	2,11
112-07-1	61	2,11
112-08-1	61	2,11
112-09-1	61	2,11
112-10-1	61	2,11
112-11-1	61	2,11
112-12-1	61	2,11
112-13-1	61	2,32
112-14-1	61	2,32
112-15-1	61	2,32
112-16-1	61	2,73
112-17-1	61	2,73
112-18-1	61	3,00
112-19-1	61	3,00
112-20-1	61	3,00
112-21-1	61	3,27
112-22-1	61	3,27
113-07-1	61	6,54
113-08-1	61	6,54
113-09-1	61	6,54
113-10-1	61	6,54
113-11-1	61	6,54
113-12-1	61	6,94
113-13-1	61	6,94
113-14-1	61	6,94
113-16-1	61	6,94
113-17-1	61	8,18
113-19-1	61	8,18
115-20-1	62	4,11
115-22-1	62	5,60
115-24-1	62	5,92
115-40-1	63	10,58
115-42-1	62	7,23
115-43-1	62	5,30
115-44-1	63	7,23
115-46-1	63	5,60
115-48-1	63	4,35
115-70-1	62	14,88
115501	62	44,91
119-18-4	63	45,78
121-08-1	64	3,49
121-09-1	64	3,49

🔍	📖	€
121-10-1	64	3,46
121-11-1	64	3,52
121-12-1	64	3,78
121-13-1	64	3,93
121-14-1	64	4,16
121-15-1	64	4,23
121-16-1	64	4,41
121-17-1	64	4,52
121-18-1	64	4,52
121-19-1	64	4,76
121-20-1	64	4,83
121-21-1	64	5,01
121-22-1	64	5,18
121-23-1	64	5,41
121-24-1	64	5,76
121-25-1	64	5,84
121-26-1	64	5,98
121-27-1	64	6,23
121-28-1	64	6,61
121-30-1	64	6,91
121-32-1	64	7,10
121-34-1	64	9,17
121-36-1	64	12,90
122-08-1	64	3,49
122-09-1	64	3,49
122-10-1	64	3,46
122-11-1	64	3,52
122-12-1	64	3,78
122-13-1	64	3,93
122-14-1	64	4,16
122-15-1	64	4,23
122-16-1	64	4,41
122-17-1	64	4,52
122-18-1	64	4,52
122-19-1	64	4,76
122-20-1	64	4,83
122-21-1	64	5,01
122-22-1	64	5,18
122-23-1	64	5,41
122-24-1	64	5,76
122-27-1	64	6,23
122-30-1	64	6,91
122-32-1	64	7,10
122-34-1	64	9,17
122-36-1	64	12,90
122A-10-1	64	3,52
122A-11-1	64	3,54
122A-12-1	64	3,57
122A-14-1	64	3,68
122A-16-1	64	4,02
122A-18-1	64	4,26
122A-20-1	64	4,52
122A-22-1	64	4,71
122A-24-1	64	4,91
122A-26-1	64	5,15
122A-28-1	64	5,36
122A-30-1	64	5,98
122A-34-1	64	6,44
122A-38-1	64	7,13
122A-40-1	64	7,30
124-10-1	65	9,59

€	📖	€
124-11-1	65	9,67
124-12-1	65	9,67
124-13-1	65	9,85
124-14-1	65	10,45
124-15-1	65	10,45
124-16-1	65	10,45
124-17-1	65	10,45
124-18-1	65	10,45
124-19-1	65	10,45
124-21-1	65	10,71
124-22-1	65	15,03
124-24-1	65	15,11
124-27-1	65	15,38
124-30-1	65	16,66
124-32-1	65	19,78
124A-18-1	65	10,66
124A-20-1	65	10,66
124A-22-1	65	10,88
124A-24-1	65	15,33
124A-26-1	65	15,42
125-22-1	68	7,74
125-23-1	68	8,13
125-25-1	68	10,01
125-40-1	70	17,28
125-42-1	69	13,40
125-43-1	69	6,36
125-44-1	69	11,05
125-46-1	69	9,16
125-48-1	70	5,82
125-49-1	69	18,48
125-52-1	68	26,59
125-53-1	69	8,88
125-54-1	69	11,15
125-60-1	69	9,85
125-70-1	67	17,44
125-70-12DISP	68	209,33
125501	67	50,74
126-10-1	65	5,48
126-11-1	65	5,48
126-12-1	65	5,65
126-14-1	65	5,65
126-16-1	65	5,76
126-18-1	65	5,76
126-20-1	65	5,98
126-24-1	65	6,65
129-10-4	68	42,41
129-101-4	73	128,54
129-108-4	72	144,89
129-12-4	68	42,00
129-172-4	73	206,60
129-23-4	70	78,95
129-33W-4	70	105,76
129-58-4	71	102,23
129-9H-4	66	42,31
129-9T-4	66	43,38
129A-103-4	72	147,14
129A-53-4	71	102,48
131-19-1	74	10,04
131-21-1	74	10,19
131-22-1	74	10,33
131-23-1	74	10,69

€	📖	€
131-24-1	74	11,07
131-25-1	74	11,07
131-26-1	74	11,44
131-27-1	74	11,44
131-28-1	74	12,00
131-29-1	74	12,37
131-30-1	74	12,82
131-32-1	74	13,11
131-33-1	74	13,77
131-34-1	74	14,06
131-35-1	74	14,31
131-36-1	74	15,15
131-38-1	74	16,38
131-40-1	74	17,30
131-41-1	74	18,06
131-42-1	74	19,15
131-46-1	74	21,30
131-50-1	74	24,27
131-55-1	74	29,20
131-60-1	74	32,47
131B-19-2	75	10,04
131B-21-2	75	10,19
131B-22-2	75	10,33
131B-23-2	75	10,69
131B-24-2	75	11,07
131B-26-2	75	11,44
131B-27-2	75	11,44
131B-29-2	75	12,37
131B-30-2	75	12,82
131B-32-2	75	13,11
131B-35-2	75	14,31
131B-36-2	75	15,15
131B-38-2	75	16,38
131B-41-2	75	18,06
131B-46-2	75	21,30
131B-50-2	75	24,27
132A-28-1	75	10,60
132A-30-1	75	11,15
132A-32-1	75	11,25
132A-34-1	75	11,62
132A-36-1	75	12,18
132A-40-1	75	13,48
132A-42-1	75	14,60
132A-44-1	75	14,88
132A-46-1	75	15,44
132A-48-1	75	16,74
132A-52-1	75	18,33
132A-54-1	75	19,45
132A-60-1	75	24,93
132A-64-1	75	24,93
135-21-1	75	18,21
135-22-1	75	21,39
135-24-1	75	28,55
135-40-1	76	47,90
135-42-1	75	32,84
135-43-1	76	12,82
135-46-1	76	15,36
135-52-1	76	40,27
135-70-1	75	67,10
135-85-1	75	14,36
139-17-4	76	201,77

€	📖	€
139-21-4	76	235,63
139-21B-4	77	235,63
1467-A01	159	27,42
149-164-4	74	305,16
15-0607-1	45	5,39
15-0809-1	45	5,91
15-1011-1	45	6,26
15-12-W	45	132,39
15-1213-1	45	6,73
15-1415-1	45	7,13
15-1617-1	45	8,51
15-1719-1	45	9,92
15-1819-1	45	9,92
15-2022-1	45	11,40
15-2123-1	45	12,98
15-2426-1	45	16,05
15-2427-1	45	16,30
15-2528-1	45	18,73
15-2729-1	45	20,78
15-3032-1	45	22,84
15-3236-2	45	36,35
15-3641-2	45	45,47
15-8-H	45	61,25
15-8-W	45	64,46
160-07-1	77	2,45
160-08-1	77	2,45
160-10-1	77	2,45
160-11-1	77	2,45
160-12-1	77	2,45
160-13-1	77	2,69
160-14-1	77	2,69
160-15-1	77	2,69
160-16-1	77	3,16
160-17-1	77	3,16
160-18-1	77	3,47
160-19-1	77	3,47
160-20-1	77	3,47
160-21-1	77	3,80
160-24-1	77	4,53
161-10-1	77	7,59
161-13-1	77	8,05
161-17-1	77	9,49
162-00-1	78	4,79
162-02-1	78	6,50
162-50-1	78	12,29
162-60-1	78	8,39
162-65-1	78	6,50
162931	78	4,79
162941	78	4,79
167-08-1	79	4,05
167-10-1	79	4,02
167-10-4	79	35,35
167-12-1	79	4,38
167-13-1	79	4,57
167-14-1	79	4,81
167-15-1	79	4,90
167-16-1	79	5,12
167-17-1	79	5,26
167-18-1	79	5,26
167-19-1	79	5,52
167-20-1	79	5,61

🔍	📖	€
167-21-1	79	5,82
167-22-1	79	6,00
167-23-1	79	6,29
167-24-1	79	6,68
167-26-1	79	6,95
167-27-1	79	7,23
167-30-1	79	8,02
167-32-1	79	8,23
167-34-1	79	9,83
167-36-1	79	10,12
167-38-1	79	12,91
167-41-1	79	13,48
167-90-2	79	46,81
167-91-2	79	30,05
168-10-1	80	11,13
168-11-1	80	11,23
168-13-1	80	11,44
168-14-1	80	12,13
168-16-1	80	12,13
168-17-1	80	12,13
168-18-1	80	12,13
168-19-1	80	12,13
168-21-1	80	12,42
168-22-1	80	17,45
168-23-1	80	17,50
168-24-1	80	17,54
168-27-1	80	17,86
168-30-1	80	19,34
168-32-1	80	21,51
168-90-2	80	97,28
169-01-1	80	9,42
169-02-1	80	11,64
169-03-1	80	8,96
169-25-1	80	20,05
169-60-1	80	12,82
169-65-1	80	10,64
169921	80	4,81
169931	80	4,81
173-01-5	81	121,92
173-17-2	81	11,05
173-18-2	81	11,35
173-19-2	81	11,66
173-21-2	81	11,83
173-22-2	81	12,00
173-23-2	81	12,41
173-24-2	81	12,85
173-27-2	81	13,28
173-28-2	81	13,93
173-29-2	81	14,37
173-30-2	81	14,89
173-32-2	81	15,22
173-33-2	81	16,00
173-34-2	81	16,30
173-36-2	81	17,60
173-38-2	81	19,01
173-41-2	81	20,97
173-46-2	81	24,73
173-50-2	81	28,19
173-55-2	81	33,90
173-60-2	81	37,70
174-17-2	81	19,06

🔍	📖	€
174-19-2	81	20,10
174-21-2	81	20,40
174-22-2	81	20,69
174-24-2	81	22,18
174-27-2	81	22,90
174-30-2	81	27,11
174-32-2	81	27,69
174-33-2	81	29,09
174-34-2	81	31,36
174-36-2	81	33,83
174-41-2	81	40,28
175-01-2	82	21,16
175-02-2	82	33,16
175-10-2	82	24,84
175-25-2	81	55,60
175-60-2	82	30,07
175-65-2	82	17,82
175911	81	5,46
177-10-5	82	156,92
177-22-2	82	18,62
177-24-2	82	19,95
177-27-2	82	20,61
177-30-2	82	22,31
177-32-2	82	22,78
177-33-2	82	23,94
177-34-2	82	21,08
177-36-2	82	25,25
177-38-2	82	27,28
177-41-2	82	31,60
177-42-2	82	31,91
177-46-2	82	33,75
177-50-2	82	42,96
177-55-2	82	49,05
177-60-2	82	58,38
177-65-2	82	65,66
177-70-2	82	71,79
177-75-2	82	79,16
177-80-2	82	93,28
178-22-2	83	24,19
178-24-2	83	25,93
178-27-2	83	26,78
178-30-2	83	27,47
178-32-2	83	28,05
178-33-2	83	30,74
178-34-2	83	27,06
178-36-2	83	30,40
178-38-2	83	32,84
178-41-2	83	40,87
178-46-2	83	32,66
178-50-2	83	41,65
178-55-2	83	52,58
178-60-2	83	60,80
179-00-2	83	78,98
179-01-2	83	85,06
179-02-2	83	99,16
179-52-2	83	187,91
179-65-2	83	18,60
179931	81-83	6,17
179941	83	8,13
18-06-1	41	7,33
18-07-1	41	7,33

🔍	📖	€
18-08-1	41	7,33
18-09-1	41	7,51
18-10-1	41	7,51
18-11-1	41	7,95
18-12-1	41	8,31
18-12-H	42	113,65
18-13-1	41	9,34
18-14-1	41	10,02
18-15-1	41	10,44
18-16-1	41	11,42
18-17-1	41	12,21
18-18-1	41	12,82
18-19-1	41	13,37
18-21-1	41	16,19
18-22-1	41	17,69
18-24-1	41	20,12
18-27-1	41	26,46
18-30-1	41	31,22
18-32-1	41	40,26
18-8-H	41	75,12
180-04-1	66	8,63
180-05-1	66	8,63
180-05X-1	66	9,59
180-06-1	66	8,63
180-06X-1	66	9,59
180-07-1	66	8,98
180-07X-1	66	9,85
180-08-1	66	8,98
180-08X-1	66	9,85
180-10-1	66	8,98
180-10X-1	66	9,85
180-12-1	66	9,85
180-12X-1	66	11,65
180-14-1	66	9,85
180-17-1	66	11,65
180-19-1	66	16,70
183-20-1	66	9,25
183-25-1	66	9,25
183-27-1	66	9,25
183-30-1	66	9,25
183-40-1	66	9,32
183-40X-1	66	10,19
183-45-1	66	9,32
183-45X-1	66	10,19
183-50-1	66	9,32
183-50X-1	66	10,19
183-55-1	66	11,82
183-55X-1	66	16,85
183-60-1	66	12,18
185-05-1	67	10,71
185-06-1	67	10,71
185-06X-1	67	10,89
185-08-1	67	10,71
185-08X-1	67	10,89
185-10-1	67	10,89
185-10X-1	67	11,65
185-12-1	67	11,65
185-12X-1	67	13,30
185-14-1	67	11,65
185-16-1	67	13,91
18D-5-H	42	50,65

€	📖	€
18S-08-1	42	5,56
18S-10-1	42	5,73
18S-13-1	42	7,00
18S-17-1	42	9,06
18S-19-1	42	10,10
18S-5-H	42	37,47
19-08-1	43	9,34
19-10-1	43	9,59
19-11-1	43	10,09
19-12-1	43	10,51
19-12-H	43	140,11
19-13-1	43	11,85
19-14-1	43	12,82
19-17-1	43	15,51
19-19-1	43	16,98
19-8-H	43	96,50
190-10-135	103	17,39
190-6-135	103	17,39
190-7-135	103	17,39
190-8-135	103	17,39
191-10-175	109	12,54
191-12-175	109	13,89
191-13-175	109	14,81
191-6-150	109	10,74
191-7-175	109	11,61
191-8-175	109	11,81
201231	86	217,93
201241	86	290,54
201251	86	400,18
201261	86	568,79
201431	89	56,88
201451	89	86,79
201461	89	100,28
201471	89	130,19
202-100	87	18,86
202-125	87	23,30
202-150	87	26,71
202401	87	22,40
202411	87	22,94
202421	87	33,93
202431	87	33,93
202441	87	22,94
202451	87	41,52
202461	87	49,47
202511	88	33,07
202521	88	34,47
202541	88	35,72
202561	88	33,32
202571	88	34,60
202581	88	36,03
202661	89	39,17
202671	89	40,91
202681	89	42,01
202761	89	38,05
202771	89	39,17
202781	89	40,73
202811	88	43,93
202821	88	71,25
202831	88	52,26
202841	88	121,18
206-100	88	20,83

€	📖	€
206-125	88	25,22
206-150	88	28,13
206721	87	30,61
206741	87	38,02
206761	87	38,02
206821	88	40,25
206831	88	57,28
206841	88	102,40
206851	88	131,73
207-100	87	146,53
207-125	87	219,78
207-150	87	286,95
207041	86	226,14
207051	86	316,58
207061	86	407,04
207071	86	542,71
216041	86	265,74
216051	86	357,09
216061	86	451,21
216071	86	586,83
217-50-B	89	36,26
25-06-1	39	2,75
25-06-2	39	2,75
25-07-1	39	2,81
25-07-2	39	2,81
25-08-1	39	2,88
25-08-2	39	2,88
25-09-1	39	3,42
25-09-2	39	3,42
25-10-1	39	3,44
25-10-2	39	3,44
25-100-2	39	719,49
25-11-1	39	3,75
25-11-2	39	3,75
25-12-1	39	3,96
25-12-2	39	3,96
25-12-H	40	85,65
25-12-W	41	113,76
25-13-1	39	4,19
25-13-2	39	3,73
25-14-1	39	4,36
25-14-2	39	3,88
25-15-1	39	4,49
25-15-2	39	4,03
25-16-1	39	4,76
25-16-2	39	4,29
25-17-1	39	5,09
25-17-2	39	4,63
25-18-1	39	5,36
25-18-2	39	4,90
25-19-1	39	6,12
25-19-2	39	5,66
25-20-1	39	6,18
25-20-2	39	5,72
25-21-1	39	7,08
25-21-2	39	6,61
25-22-1	39	7,14
25-22-2	39	6,68
25-23-1	39	7,55
25-23-2	39	7,09
25-24-1	39	7,91

€	📖	€
25-24-2	39	7,45
25-25-1	39	8,57
25-25-2	39	8,09
25-26-1	39	10,18
25-26-2	39	9,72
25-27-1	39	11,25
25-27-2	39	10,77
25-28-1	39	11,96
25-28-2	39	11,49
25-29-1	39	12,26
25-29-2	39	11,79
25-30-1	39	13,62
25-30-2	39	13,16
25-32-1	39	14,69
25-32-2	39	14,23
25-34-1	39	18,43
25-34-2	39	17,97
25-36-2	39	27,46
25-41-2	39	38,48
25-46-2	39	49,68
25-50-2	39	57,79
25-55-2	39	130,08
25-60-2	39	172,72
25-65-2	39	230,14
25-70-2	39	273,66
25-75-2	39	345,00
25-8-H	40	36,59
25-80-2	39	466,22
25-85-2	39	581,34
25-90-2	39	581,34
25-95-2	39	581,34
254-1200-2	91	15,22
254-150-2	91	7,82
254-300-2	91	8,76
254-450-2	91	10,44
254-600-2	91	11,73
254-900-2	91	15,17
255011	90	11,58
255021	90	12,26
255031	90	13,21
255041	90	14,10
255051	90	15,32
256001	90	19,17
256011	90	20,59
256031	90	23,18
256041	90	25,50
256131	90	24,95
256141	90	27,03
256151	90	29,47
256161	90	31,41
256181	90	36,05
256201	90	40,95
256231	90	44,67
256241	90	47,63
256251	90	50,37
256261	90	52,70
256281	90	57,78
256301	90	62,20
256321	90	66,01
257-200-2	91	59,86
257-300-2	91	63,31

🔍	📖	€
257-400-2	91	66,03
257-500-2	91	70,10
257-600-2	91	73,44
258-100-2	90	12,09
258-120-2	90	12,66
258-160-2	90	15,60
258-200-2	90	27,11
258-250-2	90	27,92
258-300-2	90	28,78
25A-08-1	40	2,84
25A-08-2	40	2,36
25A-10-1	40	2,93
25A-10-2	40	2,47
25A-12-1	40	3,48
25A-12-2	40	3,02
25A-14-1	40	3,87
25A-14-2	40	3,41
25A-16-1	40	4,28
25A-16-2	40	3,83
25A-18-1	40	4,47
25A-18-2	40	4,00
25A-20-1	40	4,89
25A-20-2	40	4,42
25A-22-1	40	5,18
25A-22-2	40	4,71
25A-24-1	40	6,18
25A-24-2	40	5,72
25A-26-1	40	7,21
25A-26-2	40	6,74
25A-28-1	40	7,31
25A-28-2	40	6,85
25A-30-1	40	8,15
25A-30-2	40	7,68
25A-32-1	40	8,79
25A-32-2	40	8,33
25A-34-1	40	11,42
25A-36-1	40	12,19
25A-40-1	40	14,94
25A-44-1	40	27,38
25A-46-1	40	27,82
25A-48-1	40	28,25
25A-52-1	40	39,42
25A-58-1	40	66,75
25A-64-1	40	77,35
29-3550-2	49	23,38
29-5080-2	49	31,88
29-80120-2	49	44,59
29P-3550-2	49	25,50
29P-3550-A	49	5,06
29P-5080-2	49	34,65
29P-5080-A	49	5,74
29P-80120-2	49	48,40
29P-80120-A	49	6,30
3.6SDR	189	44,20
30-100-2	48	290,75
30-24-2	48	31,74
30-27-2	48	34,53
30-30-2	48	35,57
30-32-2	48	35,57
30-34-2	48	40,30
30-36-2	48	45,40

🔍	📖	€
30-38-2	48	53,43
30-41-2	48	56,87
30-46-2	48	63,54
30-50-2	48	71,43
30-55-2	48	81,69
30-60-2	48	86,13
30-65-2	48	89,53
30-70-2	48	93,42
30-75-2	48	100,33
30-80-2	48	133,47
30-85-2	48	178,72
30-90-2	48	233,67
30-95-2	48	258,18
302-210-2	94	15,59
302-260-2	94	17,34
302-310-2	94	20,23
302-365-2	94	21,68
302-465-2	94	30,34
302-615-2	94	50,42
302-900-2	94	97,05
302S-210-2	94	11,47
302S-260-2	94	15,93
302S-310-2	94	17,60
302S-365-2	94	17,72
302S-465-2	94	27,75
302S-615-2	94	38,85
302S-900-2	94	69,39
302T-210-2	94	9,57
302T-260-2	94	9,00
302T-310-2	94	9,05
302T-365-2	94	9,29
302T-465-2	94	9,69
302T-615-2	94	15,44
302T-900-2	94	23,92
303081	95	26,85
303111	95	34,83
303121	95	47,58
303131	95	74,22
303171	95	127,65
303201	95	34,42
303211	95	46,98
303221	95	73,11
303231	95	110,28
303241	95	205,98
303291	95	37,27
303301	95	44,53
303311	95	56,59
303321	95	84,58
303331	95	208,62
304-250-2	94	24,18
304-350-2	94	32,15
304-450-2	94	45,91
304-600-2	94	76,50
304-900-2	94	147,98
304F-250-2	94	13,87
304F-350-2	94	14,55
304F-450-2	94	16,91
304F-600-2	94	19,69
304F-900-2	94	30,52
304S-250-2	94	15,30
304S-350-2	94	19,55

🔍	📖	€
304S-450-2	94	28,42
304S-600-2	94	42,20
304S-900-2	94	79,23
304T-250-2	94	6,22
304T-350-2	94	7,43
304T-450-2	94	9,98
304T-600-2	94	13,90
304T-900-2	94	24,63
307-1122-2	95	396,50
307-350-2	95	97,33
307-685-2	95	180,10
307-940-2	95	229,60
307S-1122-2	95	172,75
307S-350-2	95	37,24
307S-685-2	95	51,96
307S-940-2	95	81,71
31-30-2	48	20,78
31-32-2	48	22,05
31-36-2	48	28,40
31-41-2	48	34,82
31-46-2	48	46,90
31-50-2	48	53,43
31-55-2	48	62,32
31-60-2	48	74,21
31-65-2	48	92,98
31-70-2	48	111,80
31-75-2	48	119,72
31-80-2	48	167,50
31-85-2	48	199,45
321-42-1	96	58,10
321-BLADE-1	96	18,19
321161	96	14,55
321171	96	17,85
321281	96	18,38
321361	96	47,21
321501	96	120,72
321511	96	5,08
321551	96	8,28
330021	97	25,98
332-51-4	97	88,04
332-52-4	97	159,63
332S-030-2	97	12,41
333-003-2	97	12,41
333-004-2	97	12,41
333-006-2	97	12,41
333-008-2	97	12,41
333-010-2	97	12,41
333-012-2	97	18,45
333-014-2	97	18,45
333-016-2	97	18,45
333-018-2	97	18,45
333-020-2	97	18,45
333-022-2	97	20,50
333-024-2	97	20,50
333-026-2	97	20,50
333-028-2	97	20,50
333-030-2	97	20,50
407-10-200	100	9,16
407-12-250	100	11,87
407-14-250	100	14,75
407-4-100	100	3,43

€	📖	€
407-4-75	100	3,37
407-5.5-100	100	4,28
407-5.5-125	100	4,42
407-6.5-125	100	5,52
407-6.5-150	100	6,19
407-8-150	100	6,96
407-8-175	100	7,13
408-2.5-75	100	2,47
408-3-100	100	2,96
408-3-200	100	4,28
408-3-75	100	2,75
408-3.5-100	100	3,06
408-4-100	100	3,52
408-4-125	100	3,55
408-4-250	100	5,39
408-5.5-125	100	4,42
408-5.5-150	100	4,97
408-5.5-25	100	5,81
408-5.5-300	100	6,36
408-6.5-150	100	5,98
408-6.5-25	100	6,14
408V-2.5-100	104	4,32
408V-3-100	104	4,45
408V-3.5-100	104	4,67
408V-4-100	104	4,83
408V-5.5-125	104	6,54
408V-6.5-150	104	7,42
408V-8-175	104	8,49
409-0-75	101	3,37
409-1-100	101	4,12
409-1-25	101	6,03
409-1-250	101	6,19
409-2-125	101	5,13
409-2-25	101	6,24
409-2-300	101	7,68
409-3-150	101	7,94
409-4-200	101	11,03
409V-0-100	104	4,42
409V-1-150	104	5,52
409V-2-175	104	7,29
409V-3-200	104	8,84
413-0-75	101	3,98
413-1-100	101	4,58
413-1-25	101	5,11
413-2-125	101	5,56
413-2-25	101	5,11
413-3-150	101	8,27
413-4-200	101	10,50
413V-0-100	104	5,05
413V-1-150	104	6,32
413V-2-175	104	7,29
413V-3-200	104	8,84
414-10-75	102	4,38
414-15-100	102	4,58
414-20-100	102	4,62
414-25-125	102	5,43
414-27-125	102	5,39
414-30-150	102	6,49
414-40-150	102	7,89
414-45-150	102	8,29
414-5-75	102	4,76

€	📖	€
414-6-75	102	3,62
414-7-75	102	3,62
414-8-75	102	3,62
414-9-75	102	3,62
414V-10-100	104	5,32
414V-15-125	104	6,65
414V-20-125	104	7,68
414V-25-150	104	9,30
417-10-125	102	11,62
417-11-125	102	12,64
417-12-125	102	13,07
417-13-125	102	15,01
417-14-125	102	15,61
417-3.2-125	102	9,59
417-4-125	102	8,82
417-4.5-125	102	8,82
417-5-125	102	9,16
417-5.5-125	102	9,16
417-6-125	102	9,16
417-7-125	102	10,26
417-8-125	102	10,52
417-9-125	102	11,12
42-H10-200	108	13,40
42-H2-100	108	6,45
42-H2.5-100	108	6,45
42-H3-100	108	6,52
42-H4-150	108	7,38
42-H5-150	108	7,69
42-H6-200	108	11,05
42-H8-200	108	12,11
420-3-1	113	8,52
427411	110	4,01
429-03-1	111	3,85
429-04-1	111	3,78
429-10-1	111	4,72
42B-6-B	109	62,09
42B-H10-200	109	14,32
42B-H3-100	109	6,96
42B-H4-150	109	7,89
42B-H5-150	109	8,20
42B-H6-200	109	11,79
42B-H8-200	109	12,92
45-00-1	114	0,51
45-01-1	114	0,51
45-02-1	114	0,56
45-03-1	114	0,65
45-04-1	114	0,66
45-05-1	114	0,95
45-06-1	114	1,14
45-08-1	114	1,73
45-10-1	114	2,42
454-8-F	118	13,82
454-9-H	118	24,50
454091	118	4,89
454101	118	5,01
454151	118	5,14
454201	118	5,33
454251	118	5,39
454271	118	5,48
454301	118	5,56
454401	118	5,79

€	📖	€
457-10-1	117	4,41
457-15-1	117	4,50
457-20-1	117	4,67
457-25-1	117	4,72
457-27-1	117	4,81
457-30-1	117	4,87
457-40-1	117	5,08
457-45-1	117	5,30
457-50-1	117	6,04
457061	117	3,88
457071	117	3,93
457081	117	3,99
457091	117	4,04
457101	117	4,13
457151	117	4,23
457201	117	4,41
457251	117	4,45
457271	117	4,53
457301	117	4,58
457401	117	4,79
457451	117	5,01
457501	117	5,70
458-02-1	110	4,57
458-8-F	117	10,98
458-9-H	117	19,07
459-5-B	106	21,76
459-6-C	105	26,39
459-6A-C	105	26,39
459-6B-C	106	30,91
459-6C-C	106	25,31
459V-3-1	105	19,34
459V-6-C	108	39,18
46-8-F	114	10,85
46-9-H	114	7,56
46-T10-100	109	7,96
46-T15-150	109	8,62
46-T20-150	109	8,88
46-T25-150	109	9,48
46-T30-200	109	9,80
46-T40-200	109	10,66
461-6-B	111	11,28
47-00-1	116	1,25
47-01-1	116	1,41
47-02-1	116	1,48
47-03-1	116	1,54
47-04-1	116	1,82
47-05-1	116	2,20
47-06-1	116	3,34
47-08-1	116	4,65
47-10-1	116	8,32
470-10.0-1	128	8,00
470-12.0-1	128	8,20
470-14.0-1	128	10,93
470-5.5-1	128	5,57
470-6.5-1	128	5,69
470-8.0-1	128	6,05
470-H10-1	128	6,56
470-H4-1	128	4,54
470-H5-1	128	4,54
470-H6-1	128	4,54
470-H7-1	128	4,54

€	📖	€
470-H8-1	128	4,54
470-PH1-1	128	3,79
470-PH2-1	128	3,79
470-PH3-1	128	3,79
470-PH4-1	128	4,75
470-T20-1	128	4,88
470-T25-1	128	4,88
470-T27-1	128	4,88
470-T30-1	128	4,88
470-T40-1	128	4,88
470-T45-1	128	4,88
470-T50-1	128	5,69
470-T55-1	128	6,59
470011	129	28,54
470051	129	6,62
471-18-1	127	18,58
471011	129	58,71
471151	132	77,48
474M-1/4-1	124	5,99
474M-10-1	124	5,48
474M-11-1	124	5,48
474M-12-1	124	5,48
474M-13-1	124	5,48
474M-3/8-1	124	5,48
474M-5-H	124	23,14
474M-5.5-1	124	5,48
474M-6-1	124	5,30
474M-7-1	124	5,30
474M-8-1	124	5,30
474M-9-1	124	5,42
474MR-10-1	124	5,59
474MR-8-1	124	5,48
475-1/4-125	102	17,19
475-1/4F-160	102	17,04
475-150PH1-1	120	13,94
475-150PH2-1	120	13,94
475-150PZ1-1	121	13,94
475-150PZ2-1	121	13,94
475-150T10-1	122	11,01
475-150T15-1	122	11,01
475-150T20-1	122	11,01
475-150T25-1	122	11,01
475-150T30-1	122	11,01
475-150T40-1	122	11,01
475-32-1	126	12,58
475-32-8DISP	126	100,65
475-32A-1	126	27,44
475-4-1	119	6,77
475-4.5-1	119	6,77
475-5-1	110	6,95
475-5.5-1	119	6,77
475-50PH1-1	119	7,16
475-50PH2-1	119	7,16
475-50PH3-1	119	7,16
475-50PZ1-1	120	7,16
475-50PZ2-1	120	7,16
475-50PZ3-1	120	7,16
475-50T10-1	121	7,34
475-50T15-1	121	7,51
475-50T20-1	121	7,51
475-50T25-1	121	7,57

€	📖	€
475-50T30-1	121	7,57
475-50T40-1	121	7,57
475-50T6-1	121	7,34
475-50T8-1	121	7,34
475-6.0-1	119	6,89
475-6.5-1	119	7,28
475-61-1	127	22,33
475-70-3.0-1	119	8,98
475-70-3.5-1	119	9,04
475-70-5.5-1	119	9,20
475-70-6.5-1	119	9,54
475-70PH1-1	119	9,60
475-70PH2-1	119	9,60
475-70PH3-1	119	9,60
475-70PZ1-1	121	9,60
475-70PZ2-1	121	9,60
475-70PZ3-1	121	9,60
475-8.0-1	119	10,62
475-89PH1-1	120	11,12
475-89PH2-1	120	11,12
475-89PH3-1	120	11,12
475-89PZ1-1	121	11,12
475-89PZ2-1	121	11,12
475-89PZ3-1	121	11,12
475-89T10-1	122	8,47
475-89T15-1	122	8,47
475-89T20-1	122	8,47
475-89T25-1	122	8,47
475-89T27-1	122	8,47
475-89T30-1	122	8,47
475-89T40-1	122	8,47
475-9-1	127	7,84
475-H3-1	122	6,94
475-H4-1	122	6,94
475-H5-1	122	6,94
475-H6-1	122	6,94
475-PH0-1	119	3,88
475-PH1-1	119	3,88
475-PH2-1	119	3,88
475-PH2G-1	120	3,88
475-PH3-1	119	3,88
475-PZ0-1	120	3,88
475-PZ1-1	120	3,88
475-PZ2-1	120	3,88
475-PZ3-1	120	3,88
475-T10-1	121	5,95
475-T15-1	121	5,95
475-T20-1	121	5,95
475-T25-1	121	5,95
475-T27-1	121	5,95
475-T30-1	121	3,13
475-T40-1	121	3,13
475-T45-1	121	6,61
475-T5-1	121	5,82
475-T50-1	121	6,61
475-T6-1	121	5,82
475-T7-1	121	5,82
475-T8-1	121	5,82
475-T9-1	121	5,82
475-TR10-1	122	6,86
475-TR15-1	122	6,86

€	📖	€
475-TR20-1	122	6,86
475-TR25-1	122	6,86
475-TR27-1	122	6,86
475-TR30-1	122	6,86
475-TR40-1	122	6,86
475A-25-1	125	1,73
475A-50-1	125	5,41
475A-50-1/2-1	125	7,52
475A-60QR-1	125	11,01
475A-75QR-1	125	11,58
475A-M-150-1	125	10,44
475A-M-50-1	125	7,06
475A-M-75-1	125	7,46
475D-PH1-1	123	9,65
475D-PH2-1	123	9,65
475D-PH3-1	123	9,65
475D-PZ1-1	123	9,65
475D-PZ2-1	123	9,65
475D-PZ3-1	123	9,65
475R-1/4-110	103	18,06
475R-1/4-30	103	15,81
475T-PH1-1	123	9,65
475T-PH2-2	123	9,65
475T-PH3-2	123	9,65
475T-PZ1-1	123	9,65
475T-PZ2-2	123	9,65
475T-PZ3-2	123	9,65
478-4-1	111	3,88
478-4-2	111	3,27
48-9-H	116	15,52
48-9C-H	113	15,26
48A-13-H	116	16,00
5-100-1	36	11,01
5-100-2	36	9,88
5-100C-1	36	11,29
5-150-1	36	11,62
5-150-2	36	11,02
5-150C-1	36	11,83
5-200-1	36	13,37
5-200-2	36	12,59
5-200C-1	36	13,61
5-250-1	36	16,43
5-250-2	36	15,74
5-250C-1	36	16,56
5-300-1	36	21,66
5-300-2	36	21,02
5-300C-1	36	21,92
5-375-2	36	42,69
5-375C-2	36	43,06
5-4-W	37	70,09
5-450-2	36	68,92
5-450C-2	36	71,85
500-240-1	134	14,58
501-150-1	134	9,05
501-175-1	134	8,95
501-200-1	134	12,08
501-250-1	134	15,51
501-300-1	134	21,13
502-230-1	134	12,54
503-200-1	138	6,06
503-250-1	138	6,31

€	📖	€
503-300-1	138	7,25
504-150-1	134	8,51
504-175-1	134	11,28
504-200-1	134	11,86
504-250-1	134	14,09
504-300-1	134	16,08
505-150-1	134	7,45
505-200-1	134	10,24
505-250-1	134	15,10
506-150-1	134	8,61
506-175-1	134	11,01
506-200-1	134	11,68
51-06-1	46	8,21
51-07-1	46	8,58
51-08-1	46	8,75
51-09-1	46	9,52
51-10-1	46	9,85
51-11-1	46	10,31
51-12-1	46	10,81
51-13-1	46	11,80
51-14-1	46	12,80
51-15-1	46	13,80
51-16-1	46	15,20
51-17-1	46	15,50
51-18-1	46	16,91
51-19-1	46	17,52
51-20-1	46	19,61
51-21-1	46	21,73
51-22-1	46	23,42
51-23-1	46	26,73
51-24-1	46	27,13
51-25-1	46	29,81
51-26-1	46	33,54
51-27-1	46	36,53
51-28-1	46	40,01
51-29-1	46	42,73
51-30-1	46	45,12
51-32-1	46	46,84
51-8-W	46	114,08
511-100-1	135	3,37
511-105-1	135	3,37
511-110-1	135	3,37
511-115-1	135	3,78
511-130-1	135	4,48
511-91-4	135	14,99
511-92-4	135	18,42
511501	138	5,80
512-010-1	135	3,37
512-012-1	135	4,18
513-002-1	135	3,18
513-003-1	135	3,18
513-004-1	135	3,37
513-005-1	135	3,37
513-006-1	135	4,02
513-008-1	135	4,38
513-010-1	135	5,87
513-91-4	136	20,83
513-92-4	136	27,37
514-002-1	135	3,20
514-003-1	135	3,20
514-004-1	135	3,40

€	📖	€
514-005-1	135	3,40
514-006-1	135	4,06
515-002-1	136	3,67
515-003-1	136	3,67
515-004-1	136	3,67
515-005-1	136	3,78
515-006-1	136	3,78
515-007-1	136	3,78
515-008-1	136	4,57
515-009-1	136	4,57
515-010-1	136	5,71
515-91-4	137	26,15
516-002-1	136	5,15
516-003-1	136	5,15
516-004-1	136	5,15
516-005-1	136	5,15
516-006-1	136	5,15
516-008-1	136	5,82
517-120-1	137	3,82
517-130-1	137	3,94
517-135-1	137	4,01
517-140-1	137	4,09
517-145-1	137	4,18
517-150-1	137	4,53
517-91-4	137	24,61
518-004-1	137	5,79
518-006-1	137	5,79
519-91-4	136	19,60
519-92-4	137	31,55
519-93-4	138	32,03
52-06-1	46	8,21
52-07-1	46	8,58
52-08-1	46	8,75
52-09-1	46	9,52
52-10-1	46	9,85
52-11-1	46	10,31
52-12-1	46	10,81
52-13-1	46	11,80
52-14-1	46	12,80
52-15-1	46	13,80
52-16-1	46	15,20
52-17-1	46	15,50
52-18-1	46	16,91
52-19-1	46	17,52
52-20-1	46	19,61
52-21-1	46	21,73
52-22-1	46	23,42
52-23-1	46	26,73
52-24-1	46	27,13
52-25-1	46	29,81
52-26-1	46	33,54
52-27-1	46	36,53
52-28-1	46	40,01
52-29-1	46	42,73
52-30-1	46	45,12
52-32-1	46	46,84
52-8-W	46	114,08
520-13S-1	139	9,73
520-41-2	139	16,07
520-42-2	139	5,98
520-43-2	139	17,67

€	📖	€
520-61-2	139	16,78
520-63-2	139	18,45
521-51-2	139	16,04
521-52-2	139	9,03
521-53-2	139	15,32
521-54-2	139	6,25
521-71-2	139	17,50
521-73-2	139	16,39
521-81-2	139	18,96
521-82-2	139	9,19
521-83-2	139	17,47
521-84-2	139	6,39
522-21-2	140	11,67
522-22-2	140	6,63
522-23-2	140	12,25
522-31-2	140	14,58
522-32-2	140	8,31
522-33-2	140	15,32
522-41-2	140	17,50
522-42-2	140	8,60
522-43-2	140	18,38
525-11-2	140	5,49
525-12-2	140	2,60
525-21-2	140	12,15
525-22-2	140	3,93
525-31-2	140	13,41
525-32-2	140	5,11
525-41-2	140	18,24
525-42-2	140	6,43
525-43-2	140	20,06
525-61-2	140	22,31
525-62-2	140	7,59
525-71-2	140	25,52
525-72-2	140	8,47
525-81-2	140	29,48
525-82-2	140	9,19
525-91-2	140	20,45
525-92-2	140	9,79
526-31-2	141	11,75
526-32-2	141	3,93
526-41-2	141	13,08
526-42-2	141	4,38
526-51-2	141	16,74
526-52-2	141	5,98
526-53-2	141	18,42
526-61-2	141	19,39
526-62-2	141	7,29
526-71-2	141	22,45
526-72-2	141	9,19
526-91-2	141	22,69
526-92-2	141	10,06
527-31-2	141	12,06
527-32-2	141	6,86
527-33-2	141	13,27
527-41-2	141	13,81
527-43-2	141	15,19
527-51-2	141	15,83
527-52-2	141	9,77
527-53-2	141	17,41
527-61-2	141	16,42
527-63-2	141	17,62

€	📖	€
527-71-2	141	17,08
527-73-2	141	18,79
527-81-2	141	18,45
527-82-2	141	10,65
527-83-2	141	20,30
527-91-2	141	20,40
527-93-2	141	22,45
529021	143	15,92
529031	143	21,23
529041	143	30,03
529061	143	1,35
529071	143	1,86
529081	143	2,62
529091	143	3,61
529101	143	5,48
529151	143	7,45
529161	143	10,63
529171	143	13,21
529181	143	19,54
529191	143	37,62
529251	142	6,73
529261	142	8,09
529271	142	10,76
529291	142	12,15
529611	143	24,14
529621	143	39,90
529631	143	51,92
529701	143	2,53
529711	143	4,03
529721	143	5,58
529751	143	1,77
529761	143	2,03
529771	143	2,26
529781	143	2,47
529791	143	2,71
529801	143	3,00
529811	143	3,22
529821	143	3,29
530-03-2	142	13,71
530-05-2	142	15,22
530-07-2	142	17,02
530-13-2	142	9,60
530-15-2	142	9,60
531-05-2	142	21,15
531-07-2	142	21,88
531-08-2	142	22,60
531-09-2	142	25,52
531-15-2	142	5,39
531-17-2	142	5,39
531-18-2	142	7,59
531-19-2	142	7,59
534251	172	8,26
534261	172	9,20
534281	172	8,26
534291	172	9,20
534311	173	7,18
534321	173	8,70
534341	173	8,38
534351	173	10,90
534371	173	9,89
534381	173	11,90

€	📖	€
534401	173	5,72
534411	173	6,00
534501	173	65,40
534521	172	8,19
534531	172	9,08
534541	172	11,60
534551	172	14,50
534561	172	8,19
534571	172	9,08
534601	173	6,87
534611	173	8,31
534621	173	10,56
534681	173	9,89
534691	173	11,35
534701	173	15,02
534901	173	7,29
534911	173	7,56
534931	173	6,36
534941	173	6,58
536011	180	15,91
538-140-1	160	5,41
540021	180	3,13
540031	180	3,15
540041	180	3,27
540051	180	3,39
540061	180	3,49
540071	180	3,76
540081	180	3,97
540091	180	4,26
540101	180	4,77
540121	180	5,59
546-265-1	159	53,34
546-265-4	159	55,03
546-265-A	159	14,73
546-265-B	159	9,02
546021	159	177,45
546201	159	4,97
546211	159	4,97
546221	159	4,97
546251	159	18,42
548-275-1	159	95,33
548-275-M3	159	4,64
548-275-M4	159	4,64
548-275-M5	159	4,64
548-275-M6	159	4,64
549-230-2	180	8,23
550-80-4	180	29,36
551-HG-1	181	60,00
551-NOZ-1	181	3,90
560-41-1	182	19,83
560-41LP-1	181	22,44
560-BN-15	182	1,93
560-CA-10	182	2,69
560-CA-12	182	2,82
560-CA-14	182	2,94
560-HD-06	182	2,36
560-HD-08	182	2,60
560-HD-10	182	2,69
560-HD-12	182	2,82
560-HD-14	182	2,94
560-HT-1	182	12,12

€	📖	€
560-HTS-1	181	12,65
560-LD-06	182	1,77
560-LD-08	182	1,99
560-LD-10	182	2,02
560-LD-12	182	2,11
560-LD-14	182	2,17
601-160-1	146	10,58
601-180-1	146	11,45
601-200-1	146	12,06
601-3-C	147	37,11
601911	155	90,85
601M-125-1	148	10,99
601V-160-1	151	18,31
601V-180-1	151	20,39
601V-200-1	151	22,56
601V-3-C	153	61,26
602-3-C	147	37,23
604-160-1	146	11,23
604-180-1	146	18,19
604M-125-1	148	10,99
604V-160-1	151	22,73
608-160-1	147	11,36
612-160-1	146	12,61
612-200-1	146	14,33
612M-125-1	148	10,99
612V-160-1	152	19,39
612V-200-1	152	22,10
613-160-1	146	13,87
613-200-1	146	14,91
613V-160-1	152	20,44
613V-200-1	152	23,92
621551	155	16,90
621561	155	16,90
621571	155	19,30
621581	155	23,98
621591	155	31,86
621651	155	17,13
621661	155	17,13
621671	155	19,76
621681	155	25,01
621691	155	35,16
621751	155	17,71
621761	155	17,71
621771	155	19,64
621781	155	23,87
621791	155	35,39
621851	155	17,93
621861	155	17,93
621871	155	20,32
621881	155	25,01
621891	155	35,39
624-140-1	146	10,59
624-160-1	146	11,33
624-180-1	146	12,45
624M-125-1	148	10,99
624V-140-1	152	16,75
624V-160-1	152	18,77
625-180-1	146	13,78
625-200-1	146	15,03
625V-180-1	152	21,02
626M-125-1	149	10,99

€	📖	€
629-160-1	149	15,15
629V-160-1	153	24,63
630-295T-4	151	26,32
630-5HD-4	151	91,45
630-61B1-4	150	20,72
630-B1-1	150	10,94
630-B2-1	150	10,94
630-B3 -1	150	10,94
631-200-1	153	12,47
632-220-1	153	11,30
632-250-1	153	12,69
632-280-1	153	14,99
632D-250-1	154	14,87
634-200-1	147	13,97
634-250-1	147	14,45
634-300-1	147	24,07
634Q-250-1	147	20,47
634V-250-1	153	26,48
645011	158	54,50
645021	158	57,96
645031	158	60,75
645041	158	75,11
647-235-1	158	46,03
647-250-1	158	51,18
648-140-1	158	15,19
648-165-1	158	15,50
648-185-1	158	15,80
648-250-1	158	16,71
648-4-W	158	55,42
64A-190-1	156	21,10
64A-235-1	156	24,08
64B-190-1	156	21,49
64B-235-1	156	24,08
64C-300-1	157	33,27
64CA-175-1	157	23,56
64CA-300-1	157	31,06
64CA-450-1	157	52,47
64CAD-300-1	157	30,97
64L-165-1	157	16,29
64T-300-1	157	48,53
64W-300-1	157	32,58
651101	154	48,62
651111	154	77,79
651121	154	93,52
651131	154	122,76
651141	154	159,61
651201N	154	35,03
651201N2	154	35,03
651211N	154	41,74
651211N2	154	41,74
651221N	154	50,18
651221N2	154	50,18
651231N	154	65,89
651231N2	154	65,89
651241N	154	85,03
651241N2	154	85,03
655-160-1	149	21,82
655-200-1	149	26,77
658-250-1	156	21,34
659-250-1	156	21,34
660-250-1	156	21,34

€	📖	€
661-140-1	162	20,08
661-140-12-DISP	162	228,34
661051	162	9,83
661061	162	15,15
664-200-1	161	12,90
665-200-1	161	11,68
666-156-1	160	6,58
667-135-1	160	3,90
668-150-1	160	4,94
669-175-1	160	7,32
669-190-1	161	16,85
670-178-1	161	14,44
671-150-1	161	27,67
672-220-1	161	8,15
701-130-1	164	71,43
701-130-B	164	18,53
701-160-1	164	118,36
701-160-B	164	33,16
701-160-K	164	42,62
701-160-S	164	14,22
701-200-1	164	122,43
701-200-B	164	38,82
701-250-1	164	204,91
701-250-B	164	85,86
701-250-K	164	110,43
701-250-S	164	36,85
701-350-1	164	242,56
701-350-B	164	120,88
701-90-1	164	68,37
701-90-B	164	17,00
701-90-K	164	21,91
701-90-S	164	7,29
702-40-1	164	22,39
702-40-B	164	3,91
702-40-K	164-165	3,95
702-40-P	164-165	0,47
702-40-S	164-165	1,30
702-65-1	164	24,12
702-65-K	164-165	4,85
702-65-S	164-165	1,65
702-80-1	164	42,01
702-80-K	164-165	6,40
702-80-S	164-165	2,13
703-40-1	165	30,97
703-40-B	165	3,90
703-65-1	165	33,50
703-80-1	165	52,16
71-UN7-1	49	16,40
71-UN9-1	49	15,22
713001	165	206,99
713011	165	307,22
713511	165	27,08
713521	165	27,08
713531	165	28,77
713541	165	28,77
713611	165	40,23
716-5-1	166	20,82
716-8-1	166	64,51
716-M11-1	166	7,48
716-M14-1	166	9,18
716-M18-1	166	11,01

€	📖	€
716-M6-1	166	3,84
716-M8-1	166	5,37
718211	166	26,72
718231	166	34,48
720-1M-413	167	30,97
720-3M-413	167	59,49
720-LM-1	167	12,40
720031	167	5,74
722-4-1	162	10,84
730011	166	55,76
730131	166	132,18
7309-1-10	52	24,75
7309-1-11	52	24,75
7309-1-12	52	24,75
7309-1-13	52	24,75
7309-1-14	52	24,75
7309-1-17	52	24,75
7309-1-19	52	24,75
7309-1/2	53	59,86
7309-1/4	53	56,38
7309-125	52	144,98
7309-2-10	52	26,82
7309-2-11	52	26,82
7309-2-12	52	26,82
7309-2-13	52	26,82
7309-2-14	52	26,82
7309-2-17	52	26,82
7309-2-19	52	26,82
7309-2-22	52	26,82
7309-3/8	53	58,65
7309-30	52	127,13
7309-60	52	127,13
7314-1-13	53	28,21
7314-1-14	53	28,21
7314-1-17	53	28,21
7314-1-19	53	28,21
7314-1-22	53	33,91
7314-1-24	53	33,91
7314-1-27	53	38,40
7314-1-30	53	38,40
7314-1-32	53	38,40
7314-1/2	53	63,18
7314-2-13	53	29,36
7314-2-14	53	29,36
7314-2-17	53	29,36
7314-2-19	53	29,36
7314-2-22	53	33,91
7314-2-24	53	33,91
7314-2-27	53	33,91
7314-2-30	53	38,40
7314-2-32	53	38,40
7314-2-36	53	41,80
7314-2-41	53	41,80
7314-200	52	160,00
7314-335	52	173,17
740-016-2	168	51,33
740-020-2	168	64,60
740-022-2	168	64,60
740-025-2	168	74,77
740-030-2	168	79,48
740-035-2	168	95,43

🔍	📖	€
740-040-2	168	109,09
740-050-2	168	133,89
740S-008-2	168	1,81
740S-010-2	168	1,92
740S-012-2	168	3,01
740S-014-2	168	4,21
796491	165	32,68
796501	165	52,07
796511	165	20,96
796521	165	19,40
796531	165	19,40
796541	165	20,96
796551	165	1,05
796561	165	102,85
796571	165	1,76
800-111-1	171	27,40
800-131-1	170	14,63
800-141-1	171	16,77
800-151-1	171	9,71
800-168-1	170	8,23
800-208-1	170	8,66
800-228-1	170	9,10
801-011-1	172	13,55
801-041-1	171	12,73
801-145-1	172	13,07
801101	171	21,23
802-2400-1	170	8,81
802-2423-1	170	4,58
802-2451-1	170	3,72
802-3000-1	170	9,89
802-3023-1	170	4,29
802-3051-1	170	4,29
802-3600-1	170	11,32
802-3623-1	170	4,77
802-3651-1	170	4,77
803-318-5	171	9,50
803-318-50	171	1,90
803-324-5	171	9,50
803-324-50	171	1,90
803-332-5	171	9,50
803-332-50	171	1,90
805-3-C	144	19,40
806-6-B	144	30,38
810-2264-4	172	66,81
902021	26	41,37
902031	26	44,97
9020F550FF95	27	296,16
902131	26	57,30
9021FTW520	24	242,80
9021FTW520-AC1	24	10,12
9021FTW520-AC2	24	3,61
9021FTW520-AC3	24	7,91
9021FTW520-AC4	24	24,53
9021FTW520-AC5	24	9,20
9021FTW520FF1	24	533,44
9022-1-16SB	30	26,46
9022-1-19HB	30	63,80
9022-2-16HB	30	31,19
9022-2-16HBTS2	31	187,11
9022-2-19HB	30	37,54
9022-3-10	34	11,27

🔍	📖	€
9022-3-20	33	10,02
9022-3-20TS1	33	21,28
9022-3-20TS2	33	25,04
9022-3-30	33	8,77
9022-3-30TS1	33	35,05
9022-3-30TS2	33	36,31
9022-3-40	34	13,77
9022-3-40TS1	34	63,85
9022-3-40TS2	34	81,38
9022-3-50	34	23,79
9022-3-50TS1	34	86,37
9022-4-26	32	14,71
9022-4-26TS1	32	61,31
9022-4-35	32	19,62
9022-4-35TS1	32	116,50
9022-BP1	31	59,07
9022-BPW	31	99,30
9023PT565	29	63,83
9023PT565TS1	29	287,22
9024-1TS1	27	358,08
9024-1TS145	28	474,96
9062FWB160	26	69,50
9063FT90	25	73,57
9063HT150	25	61,31
9063HT150FI	25	8,00
9063HT150SW	25	9,00
9063HT300	25	91,98
9063HT300FI	25	12,00
9063HT300SW	25	13,90
9064-15	14	18,40
9064AC01	14	17,76
9064K-02	25	168,20
9064K-02T	25	46,23
9065K4	14	570,22
9066K-01	14	18,30
9066K-02	14	28,81
9066K-03	14	23,91
9066K-05	14	27,55
9066K-06	14	13,31
9066K5	14	775,16
9066K6	14	805,82
9066K6FF100	15	1.199,36
9066K6FF101	16	1.377,51
9066K7	14	831,94
9066K7FF102	17	1.601,25
910-152DISP	107	686,75
910-83DISP	107	397,36
910V-72DISP	108	409,21
971-13-1	178	7,95
971-20-1	178	10,51
972-52-1	178	11,76
980-20S-1	177	14,79
980-3-1	176	3,65
980-3B-1	176	5,69
980-5-1	176	5,21
980-5-25-1	176	8,84
980-5B-1	176	9,21
980-5W-1	177	10,04
980-8B-1	176	17,96
980-TP2-1	176	17,33
980HV-3-1	176	5,88

🔍	📖	€
980HV-5-1	176	8,50
981-1000-1	174	18,63
981-1200-1	174	20,33
981-1500-1	174	23,71
981-1800-1	174	27,96
981-2000-1	174	29,66
981-400-1	174	9,97
981-400M-1	174	14,67
981-600-1	174	12,15
981-600M-1	174	18,19
981-800-1	174	16,55
981-SET	175	63,51
982-10-1	175	6,02
982-40-1	174	13,25
982-4M-1	174	14,81
982-60-1	174	16,13
982-6M-1	174	26,90
982-80-1	174	21,98
982-SET	175	13,44
982-TOR-1	175	7,81
983-25-1	175	18,05
984-6-1	179	29,22
984-6D-1	179	40,85
985-2-1	177	4,10
991-200-1	178	8,22
991-250-1	178	9,97
991-300-1	178	11,74
991-400-1	178	14,32
993-150-1	178	11,15
993-300-1	178	15,85
993-400-1	178	18,19
CEE-COUNT-IR-1	193	-
IFF1A001	18	167,06
IFF1A002	18	170,80
IFF1A003	18	175,90
IFF1A004	19	185,68
IFF1A005	19	212,03
IFF1A006	19	200,88
IFF1A007	20	164,79
IFF1E001	20	68,39
IFF1E002	20	83,60
IFF1E003	20	59,93
IFF1E004	20	79,03
IFF1E005	20	152,84
IFF1E006	20	47,99
IFF1E007	21	41,10
IFF1E008	21	34,83
IFF1E009	21	35,58
IFF1E010	21	69,32
IFF1E011	21	61,92
IFF1E012	21	91,44
IFF1E013	22	56,64
IFF1E014	22	57,30
IFF1E015	22	141,07
IFF1E016	22	88,81
IFF1E017	22	51,37
IFF1E018	22	48,10
IFF1E019	23	60,66
IFF1E021	23	149,27
IFF1E023	23	43,46
IFF1E024	23	65,60

🔍	📖	€
IFF1E025	23	44,99
L-ALUM-1	185	5,08
L-ALUM-12DISP	185	60,98
L-BOOK-1	186	50,82
L-COMP-1	184	47,42
L-FLEX-1	184	55,36
L-HEAD-1	186	28,23
L-MINI-1	185	32,74
L-PEN-1	185	21,45
L-POCK-1	185	30,49
L-SLIM-1	184	50,82
LT-420-1	179	41,08
MEE-1S2L-B-I	190-191	—
MEE-BANNER-I	192	—
MEE-COR-1L-B-I	191	—
MEE-COR-LIGHT-I	191	—
MEE-COUNT-IR-1	193	—
MEE-COUNT-IR-2	107-108-193	—
MEE-COUNT-IR-3	107-193	—
MEE-DB-W-NL	192	—
MEE-LIGHTBOX-I	191	—
MEE-SA-SS-IR	193	—
MEE-SIGN-CARR-I	190-191	—
MEE-TR-W-I	192	—
P218	188	10,40
P254	189	46,30
P255	189	77,68
P700	188	159,01
P704	187	89,08
P800	187	154,22
P802	187	688,22
P815	187	187,27
P817	187	479,20
P821	188	198,78
PEE-COUNT-006	193	—
PEE-METHACRYL-I	192	—
PEE-PC-IR-1	193	—
PEE-SIGN-DB-W-2	192	—
PEE-TOPSIGN-I	192	—
PM5002	188	5,09
PM5003	188	4,87
PM5012	188	5,24
PM5013	188	9,80
PM5142	188	1,88
PM5143	188	1,52
PM5152	188	0,99
PM5153	188	1,52
PM5248	188	1,71
PN251	188	13,04
PPOS-A4-STICK-I	193	—

🔍	📖	€
PQCF14	188	26,86
T49	132	100,69
T4901	130	6,95
T4902	130	5,96
T49H10	130	2,67
T49H10L	130	3,97
T49H10XL	130	6,68
T49H12	130	3,16
T49H12L	130	4,98
T49H14	130	4,98
T49H4	130	2,67
T49H4L	130	3,97
T49H5	130	2,67
T49H5L	130	3,97
T49H6	130	2,67
T49H6L	130	3,97
T49H7	130	2,67
T49H7L	130	3,97
T49H8	130	2,67
T49H8L	130	3,97
T49M10	131	2,67
T49M10L	131	3,97
T49M12	131	3,16
T49M12L	131	4,98
T49M14	131	4,20
T49M5	131	2,67
T49M5L	131	3,97
T49M6	131	2,67
T49M6L	131	3,97
T49M8	131	2,67
T49M8L	131	3,97
T49SQ10	131	4,68
T49SQ8	131	3,91
T49T20	130	2,55
T49T20H	131	2,67
T49T20HL	131	3,97
T49T20L	130	3,76
T49T25	130	2,55
T49T25H	131	2,67
T49T25HL	131	3,97
T49T25L	130	3,76
T49T27	130	2,55
T49T27H	131	2,67
T49T27HL	131	3,97
T49T27L	130	3,76
T49T30	130	2,55
T49T30H	131	2,67
T49T30HL	131	3,97
T49T30L	130	3,76
T49T30XL	67-132	10,06

🔍	📖	€
T49T40	130	2,55
T49T40H	131	2,67
T49T40HL	131	3,97
T49T40L	130	3,76
T49T40XL	67-132	10,06
T49T45	130	2,55
T49T45H	131	2,67
T49T45HL	131	3,97
T49T45L	130	3,76
T49T45XL	67-132	10,06
T49T50	130	2,55
T49T50H	131	2,67
T49T50HL	131	3,97
T49T50L	130	3,76
T49T55	130	2,55
T49T55H	131	2,67
T49T55HL	131	3,97
T49T55L	130	3,76
T49T55XL	130	6,95
T49T60	130	3,95
T49T60H	131	4,15
T49T60HL	131	5,45
T49T60L	130	5,16
T49T70HL	67-132	18,01
T49T80HL	67-132	18,01
WB-300-2	138	29,44
WB-500-2	138	30,39
WB-625-2	138	34,32
WB-710-2	138	36,28
WB-900-2	138	39,03
ZH1100	166	89,71
ZH1101	166	4,11
ZH1102	166	4,11
ZH1103	166	4,11
ZH1104	166	4,11
ZH1105	166	4,11
ZH1106	166	4,11
ZH1107	166	4,11
ZH1108	166	4,11
ZH1109	166	4,11
ZH1110	166	4,11
ZH1111	166	4,11
ZH1112	166	4,11
ZH1113	166	4,11
ZH1114	166	4,11
ZH1115	166	4,11
ZH70610	168	31,50
ZH70611	168	8,42
ZH70612	168	10,84
ZH70613	168	16,85
ZH70614	168	20,46

pulgadas		mm	pulgadas		mm	pulgadas		mm
pulgadas		mm	pulgadas		mm	pulgadas		mm
.	0,0039	0,1000	.	0,5512	14,0000	.	1,8898	48,0000
.	0,0079	0,2000	9/16"	0,5625	14,2875	.	1,9291	49,0000
.	0,0118	0,3000	.	0,5709	14,5000	.	1,9685	50,0000
1/64"	0,0156	0,3969	37/64"	0,5781	14,6844	2"	2,0000	50,8000
.	0,0157	0,4000	.	0,5906	15,0000	.	2,0079	51,0000
.	0,0197	0,5000	19/32"	0,5938	15,0813	.	2,0472	52,0000
.	0,0236	0,6000	39/64"	0,6094	15,4781	.	2,0866	53,0000
.	0,0276	0,7000	.	0,6102	15,5000	.	2,1260	54,0000
1/32"	0,0313	0,7938	5/8"	0,6250	15,8750	.	2,1654	55,0000
.	0,0315	0,8000	.	0,6299	16,0000	.	2,2047	56,0000
.	0,0354	0,9000	41/64"	0,6406	16,2719	.	2,2441	57,0000
.	0,0394	1,0000	.	0,6496	16,5000	2 1/4"	2,2500	57,1500
.	0,0433	1,1000	21/32"	0,6563	16,6688	.	2,2835	58,0000
3/64"	0,0469	1,1906	.	0,6693	17,0000	.	2,3228	59,0000
.	0,0472	1,2000	43/64"	0,6719	17,0656	.	2,3622	60,0000
.	0,0512	1,3000	11/16"	0,6875	17,4625	.	2,4016	61,0000
.	0,0551	1,4000	.	0,6890	17,5000	.	2,4409	62,0000
.	0,0591	1,5000	45/64"	0,7031	17,8594	.	2,4803	63,0000
1/16"	0,0625	1,5875	.	0,7087	18,0000	2 1/2"	2,5000	63,5000
.	0,0630	1,6000	23/32"	0,7188	18,2563	.	2,5197	64,0000
.	0,0669	1,7000	.	0,7283	18,5000	.	2,5591	65,0000
.	0,0709	1,8000	47/64"	0,7344	18,6531	.	2,5984	66,0000
.	0,0748	1,9000	.	0,7480	19,0000	.	2,6378	67,0000
5/64"	0,0781	1,9844	3/4"	0,7500	19,0500	.	2,6772	68,0000
.	0,0787	2,0000	49/64"	0,7656	19,4469	.	2,7165	69,0000
.	0,0827	2,1000	.	0,7677	19,5000	2 3/4"	2,7500	69,8500
.	0,0866	2,2000	25/32"	0,7813	19,8438	.	2,7559	70,0000
.	0,0906	2,3000	.	0,7874	20,0000	.	2,7953	71,0000
3/32"	0,0938	2,3813	51/64"	0,7969	20,2406	.	2,8346	72,0000
.	0,0945	2,4000	.	0,8071	20,5000	.	2,8740	73,0000
.	0,0984	2,5000	13/16"	0,8125	20,6375	.	2,9134	74,0000
7/64"	0,1094	2,7781	.	0,8268	21,0000	.	2,9528	75,0000
.	0,1181	3,0000	53/64"	0,8281	21,0344	.	2,9921	76,0000
1/8"	0,1250	3,1750	27/32"	0,8438	21,4313	3"	3,0000	76,2000
.	0,1378	3,5000	.	0,8465	21,5000	.	3,0315	77,0000
9/64"	0,1406	3,5719	55/64"	0,8594	21,8281	.	3,0709	78,0000
5/32"	0,1563	3,9688	.	0,8661	22,0000	.	3,1102	79,0000
.	0,1575	4,0000	7/8"	0,8750	22,2250	.	3,1496	80,0000
11/64"	0,1719	4,3656	.	0,8858	22,5000	.	3,1890	81,0000
.	0,1772	4,5000	57/64"	0,8906	22,6219	.	3,2283	82,0000
3/16"	0,1875	4,7625	.	0,9055	23,0000	.	3,2677	83,0000
.	0,1969	5,0000	29/32"	0,9063	23,0188	.	3,3071	84,0000
13/64"	0,2031	5,1594	59/64"	0,9219	23,4156	.	3,3465	85,0000
.	0,2165	5,5000	.	0,9252	23,5000	.	3,3858	86,0000
7/32"	0,2188	5,5563	15/16"	0,9375	23,8125	.	3,4252	87,0000
15/64"	0,2344	5,9531	.	0,9449	24,0000	.	3,4646	88,0000
.	0,2362	6,0000	61/64"	0,9531	24,2094	3 1/2"	3,5000	88,9000
1/4"	0,2500	6,3500	.	0,9646	24,5000	.	3,5039	89,0000
.	0,2559	6,5000	31/32"	0,9688	24,6063	.	3,5433	90,0000
17/64"	0,2656	6,7469	.	0,9843	25,0000	.	3,5827	91,0000
.	0,2756	7,0000	63/64"	0,9844	25,0031	.	3,6220	92,0000
9/32"	0,2813	7,1438	1"	1,0000	25,4000	.	3,6614	93,0000
.	0,2953	7,5000	.	1,0039	25,5000	.	3,7008	94,0000
19/64"	0,2969	7,5406	.	1,0236	26,0000	.	3,7402	95,0000
5/16"	0,3125	7,9375	.	1,0433	26,5000	.	3,7795	96,0000
.	0,3150	8,0000	.	1,0630	27,0000	.	3,8189	97,0000
21/64"	0,3281	8,3344	.	1,0827	27,5000	.	3,8583	98,0000
.	0,3346	8,5000	.	1,1024	28,0000	.	3,8976	99,0000
11/32"	0,3438	8,7313	.	1,1220	28,5000	.	3,9370	100,0000
.	0,3543	9,0000	.	1,1417	29,0000	4"	4,0000	101,6000
23/64"	0,3594	9,1281	.	1,1614	29,5000	.	4,3307	110,0000
.	0,3740	9,5000	.	1,1811	30,0000	4 1/2"	4,5000	114,3000
3/8"	0,3750	9,5250	.	1,2205	31,0000	.	4,7244	120,0000
25/64"	0,3906	9,9219	1 1/4"	1,2500	31,7500	5"	5,0000	127,0000
.	0,3937	10,0000	.	1,2598	32,0000	.	5,1181	130,0000
13/32"	0,4063	10,3188	.	1,2992	33,0000	.	5,5118	140,0000
.	0,4134	10,5000	.	1,3386	34,0000	.	5,9055	150,0000
27/64"	0,4219	10,7156	.	1,3780	35,0000	6"	6,0000	152,4000
.	0,4331	11,0000	.	1,4173	36,0000	.	6,2992	160,0000
7/16"	0,4375	11,1125	.	1,4567	37,0000	.	6,6929	170,0000
.	0,4528	11,5000	.	1,4961	38,0000	.	7,0866	180,0000
29/64"	0,4531	11,5094	1 1/2"	1,5000	38,1000	.	7,4803	190,0000
15/32"	0,4688	11,9063	.	1,5354	39,0000	.	7,8740	200,0000
.	0,4724	12,0000	.	1,5748	40,0000	8"	8,0000	203,2000
31/64"	0,4844	12,3031	.	1,6142	41,0000	.	9,8425	250,0000
.	0,4921	12,5000	.	1,6535	42,0000	10"	10,0000	254,0000
1/2"	0,5000	12,7000	.	1,6929	43,0000	20"	20,0000	508,0000
.	0,5118	13,0000	.	1,7323	44,0000	30"	30,0000	762,0000
33/64"	0,5156	13,0969	1 3/4"	1,7500	44,4500	40"	40,0000	1016,0000
17/32"	0,5313	13,4938	.	1,7717	45,0000	60"	60,0000	1524,0000
.	0,5315	13,5000	.	1,8110	46,0000	80"	80,0000	2032,0000
35/64"	0,5469	13,8906	.	1,8504	47,0000	100"	100,0000	2540,0000

NORMAS

¿Qué es una norma?

Una norma es un documento que proporciona requisitos, especificaciones, directrices o características que se pueden utilizar consistentemente para asegurar que los materiales, productos, procesos y servicios se adecúan a su propósito.

¿Cuáles son los beneficios de las Normas Internacionales ISO?

Las Normas Internacionales ISO garantizan que los productos y servicios son seguros, fiables y de buena calidad. Para el negocio, son herramientas estratégicas que reducen los costos al minimizar los residuos y errores, e incrementando la productividad. Ayudan a empresas a acceder a nuevos mercados, igualando el campo de juego para los países en desarrollo y facilitando el comercio global justo y libre.

IRIMO principales familias de productos

Llaves de vaso

- ISO 2725, vasos, dimensiones generales; ISO 1174, tamaños. Las normas definen los límites de ciertas dimensiones evitando el juego entre el vaso y el perno, la accesibilidad para llegar, y garantiza la transmisión del par correcto y trabajar con las tuercas y pernos.
- ISO 1711, vasos y vasos de impacto, define la dureza mínima que debe tener un vaso, y el par mínimo que debe resistir.
Esto asegura que sólo el material adecuado ha sido utilizado, y que el vaso puede ser usado sin riesgo de rotura.
- El perfil de los vasos, hexagonal y bihexagonal, fue diseñado para una mejor distribución de la fuerza lejos de las esquinas para evitar posibles roturas. Al mismo tiempo la transmisión del par a los pernos y a las tuercas se hace fuera de los bordes, protegiendo la vida de los componentes.

Llaves ajustables

- Supera los valores ISO 6787 de par en más 30% sin abrirse ni deformarse.
- Las dimensiones de las llaves ajustables son acordes a los estándares de la norma ISO 6787.
- Diseño forjado en una sola pieza.

Llaves

- Norma ISO 1711-1 valores de par estándar, además de un 30% sin abrir y deformación.
- Dureza superior, conforme a la norma ISO 1711-1, sin riesgo de fragilidad.
- Tolerancia de ajuste de acuerdo con Norma ISO 691 da un mayor rendimiento y una mejor transmisión del par de torsión a los pernos y tuercas.

Alicates

- Las Normas ISO sobre alicates definen, para cada familia de productos, las dimensiones básicas del producto. Además de esto, cuando las normas ISO son aplicables también definen:
 - Deformaciones máximas aceptables después de una prueba de carga.
 - Deformaciones máximas aceptables después de una prueba de torsión.
 - Pruebas de fuerza de corte máximo aceptable.
- Las Normas ISO más importantes para alicates son:
 - ISO 5745 Alicates para agarrar y manipular
 - Dimensiones y valores de prueba
 - ISO 5746 Alicates para ingenieros e instaladores
 - Dimensiones y valores de prueba
 - ISO 5749 Alicates de corte diagonal
 - Dimensiones y valores de prueba
 - ISO 8976 Tenacillas de ajuste rápido
 - Dimensiones y valores de prueba
 - ISO 9242 Pinzas de los trabajadores de Construcción – Dimensiones y valores de prueba
 - ISO 9243 Alicates y tenazas de carpintero
 - Dimensiones y valores de prueba

Llaves dinamométricas

ISO 6789 clasifica las llaves dinamométricas en diferentes tipos (I, II) y clases (A, B, C, D, E, F). La norma ISO asigna diferentes niveles de precisión (4% o 6%) dependiendo del tipo, clase y par máximo de cada llave. Esta precisión debe llevarse a cabo entre 20% y 100% del par máximo de la llave. La norma también tanto se establece el procedimiento de calibración, las condiciones y la frecuencia, así como otras pruebas y requerimientos de productos. Las herramientas dinamométricas IRIMO cumplen con la norma ISO 6789 y SNA Europe ofrece servicios de calibración en sus centro post venta.

Destornilladores

Las Normas ISO sobre destornilladores definen la dimensión de punta, la dureza mínima y el par mínimo que deben resistir.

Después de la prueba de par con el valor mínimo, los destornilladores no deberían mostrar ninguna deformación en la punta:

- ISO 2380 Destornilladores de boca estampada
 - Dimensiones, dureza y valores de par mínimos.
- ISO 8764 Destornilladores Phillips y Pozidriv
 - Dimensiones, dureza y valores de par mínimos.
- ISO 2936 Destornilladores hexagonales
 - Dimensiones, dureza y valores de par mínimos.

Sin embargo, los destornilladores IRIMO deben cumplir con las Normas internas que están por encima de la norma ISO.

Las normas internas de los valores de par es un 20% más que el estándar ISO para destornilladores de boca estampada y 50% en el Phillips y Pozidriv.

La combinación de la materia prima y la dureza determina el rendimiento de la varilla, dándole un vida más larga y un trabajo de calidad.

Dureza interna; Mínimo SNA Europe 58-59 HRc. Mínimo Normativa ISO 54 HRc.

Vasos con punta TORX®; los valores de par son evaluados con galgas de Acument Global Technologies Inc., que licencia TORX®.

SNA Europe tiene el compromiso de suministrar a sus clientes productos que garantizan el cumplimiento estricto de todos los reglamentos, protocolos internacionales y normas a las que estén sujetos nuestros clientes. En base a esto, SNA Europe cumple con los reglamentos y directivas internacionales exigidas, incluyendo el REACH, minerales conflictivos, etc.

REACH es el Reglamento europeo CE N°1907/2006, que establece la obligación de realizar un registro para todo aquel que introduzca sustancias químicas en el mercado comunitario con una concentración superior al 0,1%, peso sobre peso, ya sean fabricantes o importadores de sustancias, como tales o en forma de preparados, o productores de artículos (<http://www.echa.europa.eu/candidate-list-table>). Además, la Agencia Europea de Sustancias y Mezclas Químicas (ECHA) ha añadido varias sustancias químicas a la lista de sustancias altamente preocupantes (SVHC) que requieren autorización. Siendo, desde diciembre de 2014, 161 las sustancias que se registran en mencionada lista.

La definición y objetivo de la directiva RoHS es bastante simple. Persigue restringir determinadas sustancias peligrosas usadas de manera habitual en electrónica y equipamiento electrónico. Cualquier componente que cumpla RoHS es testado para determinar la presencia de plomo (Pb), cadmio (Cd), mercurio (Hg), cromo hexavalente (Hex-Cr), bifenilos polibromados (PBB) y éteres de difenilo polibromados (PBDE).

La directiva de equipos electrónicos y residuos de aparatos eléctricos (Directiva WEEE) es la directiva de la Comunidad Europea 2012/19/EU relativa a los residuos eléctricos y de aparatos electrónicos (WEEE) que, junto con la directiva RoHS 2002/95/EC, se convirtió en Ley Europea en febrero de 2003. La Directiva WEEE establece objetivos de recogida, reciclado y recuperación de todo tipo de aparatos eléctricos, con una tasa mínima de 4 kilogramos por habitante por año recuperado para su reciclaje en 2009.

El marcado **CE** es la declaración del fabricante de que el producto cumple con los requisitos de las directivas comunitarias aplicables.

El término Minerales conflictivos se refiere a las materias primas que provienen de una parte determinada del mundo en el que se están produciendo conflictos que afectan a la minería y el comercio de esos materiales. Estos se define como la columbita-tantalita, también conocido como coltán (del que se deriva el tántalo); casiterita (estaño); oro; wolframita (tungsteno); o sus derivados; de ser la financiación de conflicto en la República Democrática del Congo o un país colindante.

SNA Europe



Para información sobre la garantía
visite la página web local

www.irimo.com/es_es/

CONDICIONES DE VENTA

1. Las presentes Condiciones Generales estarán en vigor desde el 1 de Octubre de 2022 y vienen a sustituir y dejar sin efecto a todas las Condiciones Generales anteriormente aplicadas.

2. Nuestros productos se identifican, exclusivamente, por sus referencias. Por ello, los pedidos deben mencionar, claramente en cada caso, la referencia y el número de unidades de la misma que se desea adquirir. Una vez aceptado el pedido, la obligación de SNA Europe Industries Iberia, S.A. queda limitada al suministro de dichas unidades de la referencia solicitada. Las dimensiones y características técnicas de los productos que se incluyen en nuestro catálogo comercial, son meramente ilustrativas y están sujetas a modificaciones, por lo que SNA Europe Industries Iberia, S.A. recomienda a sus clientes que, antes de formular un pedido, comprueben que la referencia solicitada se ajusta, en cuanto a dimensiones y demás características a sus necesidades.

3. SNA Europe establece un importe mínimo por pedido de 100 € a portes pagados, para la aceptación de los mismos.

4. Los precios para envíos a las provincias españolas fuera de la península se entienden para mercancía puesta en el puerto de destino (C & F).

5. La elección del medio de transporte será por cuenta de SNA Europe Industries Iberia, S.A.

6. Los clientes tienen la obligación de examinar los productos servidos a su recepción, a fin de comprobar su conformidad con el pedido en cuanto a la referencia o referencias servidas y el número de unidades entregadas. Si existiera alguna disconformidad, el cliente deberá ponerlo de manifiesto, bien rechazando la mercancía si su disconformidad es total, bien recibéndola parcialmente y haciendo constar en el albarán de entrega su queja en cuanto al producto rechazado en el caso de disconformidad parcial. La firma del albarán de entregas, sin salvedad alguna, supondrá la aceptación de la mercancía y la conformidad del cliente en cuanto a la cantidad y referencia(s) servida(s), todo ello sin perjuicio de la garantía de producto aquí prevista.

7. La transmisión de la propiedad de la mercancía en favor del cliente no tendrá lugar hasta el momento de la efectividad del completo pago de su precio, con independencia de que la misma haya sido entregada y puesta a disposición del cliente. En este caso, y hasta la efectiva transmisión de la propiedad mediante el pago, el cliente se abstendrá de realizar cualquier acto de disposición sobre la mercancía o de almacenarla y/o utilizarla de forma tal que pueda sufrir algún menoscabo, siendo responsable frente a SNA Europe Industries Iberia, S.A. del estado de la misma en este tiempo. En el supuesto de que, llegado el vencimiento del pago, este no se haga efectivo por el cliente, SNA Europe Industries Iberia, S.A. tendrá la facultad alternativa de exigir el pago del precio, con sus intereses o la devolución de la mercancía, sin perjuicio en cualquiera de ambos casos de las indemnizaciones de daños y perjuicios a la que por ley tenga derecho.

8. La mercancía será servida en función de las circunstancias del pedido (Número de unidades y clase de la referencia solicitada) y de la disponibilidad de producto de SNA Europe Industries Iberia, S.A. en el momento. Si el cliente precisa que la entrega se realice en un plazo determinado deberá ponerlo de manifiesto en su escrito de pedido, no habiendo lugar a ninguna reclamación por retraso en la entrega, salvo que expresamente se pacte otra cosa.

9. Forma de pago: A 60 días fecha factura. Los clientes que tengan día de vencimiento fijo, se les girará al más próximo a los 60 días

fecha factura, de forma que todos los giros quedarán comprendidos entre los 45 y 75 días f.f.

10. Los pedidos, una vez aceptados por SNA Europe Industries Iberia, S.A., serán irrevocables y no podrán ser anulados o modificados de ninguna manera por el cliente, salvo que medie expreso acuerdo en dicho sentido con SNA Europe Industries Iberia, S.A. Si un pedido, por la especial naturaleza de su objeto u otras circunstancias, requiere alguna clase de cambio en los procesos de fabricación y/o envasado normalmente seguidos por SNA Europe Industries Iberia, S.A., se considerará como definitivo e irrevocable en todos sus conceptos desde el mismo momento de su emisión por el cliente, viniendo éste obligado a la recepción de la mercancía en todo caso. De no hacerlo así y rehusar la mercancía SNA Europe Industries Iberia, S.A. podrá exigirle el precio del pedido, más un 50% del mismo, en concepto de penalización.

REPOSICIÓN DE GARANTÍA

1. Todos los productos del catálogo están amparados por la Garantía Total contra cualquier defecto de fabricación o material, de forma que los clientes tendrán derecho a la reposición de la pieza o piezas defectuosas siempre que el defecto tenga su origen directo en la fabricación o de material de la misma.

2. El derecho de reposición se limita a la sustitución de la pieza defectuosa por otra nueva y no comprenderá abono de ninguna clase, siendo todos los gastos de la reposición, en particular el transporte, de cargo del cliente.

3. La Garantía Total no ampara los defectos provenientes del desgaste o de la mala conservación y/o utilización de los productos por el cliente.

4. El plazo de garantía es de un año a partir de la fecha de compra en el caso de los productos sujetos a desgaste normal con el uso tales como cuchillas, puntas, brocas, y otros productos consumibles. En el caso de multiplicadores de par, la garantía no se aplicará en los casos en los que el producto haya sido sometido a esfuerzos superiores a sus valores nominales máximos.

5. Para el correcto ejercicio de este derecho el cliente deberá comunicar por escrito a SNA EUROPE INDUSTRIES IBERIA, S.A. el defecto y las piezas afectadas, indicando los datos relativos a la compra (fecha y número de factura). En el plazo de 30 días a contar desde la recepción de dicha comunicación, SNA EUROPE INDUSTRIES IBERIA, S.A. enviará a su representante de plaza a las instalaciones del cliente, a fin de suscribir conjuntamente la documentación relativa a las piezas defectuosas. Inmediatamente después las mismas o una muestra escogida por el representante de plaza, serán remitidas a SNA EUROPE INDUSTRIES IBERIA, S.A. a fin de que su Departamento de Calidad certifique el defecto. En el supuesto de que el informe del Departamento de Calidad confirme el defecto, SNA EUROPE INDUSTRIES IBERIA, S.A. lo comunicará al cliente, anunciando la reposición de las piezas defectuosas.

6. La reposición se llevará a cabo en el menor plazo de tiempo posible y como norma se producirá junto con el más próximo envío de mercancía al cliente.

7. A la recepción de las piezas repuestas, el cliente deberá suscribir un documento manifestando su conformidad con la reposición efectuada y se renuncia a cualquier reclamación posterior a SNA EUROPE INDUSTRIES IBERIA, S.A. por dicho motivo.

Este catálogo comprende nuestra gama actual de productos. De manera regular se realizan cambios tanto en la gama de productos como en el conformado final, formas, diseños y designaciones de los mismos.

Estas modificaciones no serán necesariamente notificadas.

Las ilustraciones y croquis han sido reproducidos para ser lo más precisos posibles. Sin embargo, en la elaboración de un catálogo, los mismos pueden diferir respecto a los propios productos y a las especificaciones técnicas.

Las indicaciones de peso deben entenderse como pesos netos aproximados, y sirven principalmente para facilitar el cálculo de los costes de transporte y franqueo.

Este catálogo reemplaza toda especificación y gamas previas.

La propiedad intelectual de este catálogo pertenece a SNA Europe.

Los extractos, reimpresiones o copias de los contenidos solo se pueden realizar con nuestra autorización.

2022/23

CONTACTO

Argentina

A.M. de Justo 1750 3° A
C1107AFJ - Capital Federal
Buenos Aires
Tel: +54 (11) 4313-1004
Fax: +54 (11) 4893-3553

Australia

3 Cooper Street, Smithfield,
NSW 2164
Tel: +61 (0) 2 8787 5700
Fax: +61 (0) 2 9756 6130

Беларусь

ЗАО "Эс-Эн-Эй Европа Индастриз Бисов"
220075 СЭЗ "Минск"
ул. Селицкого, д. 8А
Телефон +375 (17) 389 79 50
info.by@snaeurope.com

Belgium**Branch of SNA Europe (Benelux) BV**

De Kleetlaan 12A Pegasus Park
1831 DIEGEM
Tel: +32 (0)2 726 03 03
Fax: +32 (0)2 726 04 36

Chile

Av. Americo Vespucio 2760-D
Conchali - Santiago - Chile
Tel: +56 2 623 0203
Fax: +56 2 623 5395

Česká republika**SNA Europe s.r.o.**

Holadnská 2/4
639 00 Brno
Tel: +420 537 022 520
Fax: +420 537 022 200

Danmark

Vallensbækvej 40,
2605 Brøndby
Tel: +45 4363 0330
Fax: +45 4396 2456

Deutschland

Willetstraße 10
40822 Mettmann
Tel: +49 (0) 2104 833 83 0
Fax: +49 (0) 2104 833 83 7999

España

c/ Hilanderas, 1
(P.O. Box / Apdo de Correos nº 5)
C.P. 20303 Irún
Tel: +34 902 235 100 / +34 943 649 111
Fax: +34 943 649 120

Ελλάδα

Λ. Βουλιαγμένης 604Γ
167 77 Ελληνικό, Αθήνα
Τηλ: +30 210 9914263
Fax: +30 210 9914587

Export

Antigua Carretera de Altube Km 5,5
P.O.Box 307
01080 VITORIA (Spain)
Tel: +34 945269711
Fax: +34 945165040

France

ZAC de l'Hoirie
20 rue Charles Lacretelle
CS 60101
49072 Beaucouzé cedex
Tél: +33 (0) 2 41 22 98 40
Fax: +33 (0) 2 41 22 98 50

Italia

SNA EUROPE Italia S.p.A.
Via Georges Bizet, 13/15
20092 Cinisello Balsamo MI - Italia
Tel: +39 02 3024161
info.it@snaeurope.com

Казахстан

050000, Алматы,
ул.Шевченко 1656/72г, оф.217
Тел/факс +7 727323 63 39

Nederland

Vossenbeemd 113
5705 CL Helmond
Tel: +31 (0) 492 58 23 82
Fax: +31(0) 492 58 23 20

New Zealand

Unit 3/25 Highbrook Drive
East Tamaki
Auckland
Tel: +64 9-273 46 50
Fax: +64-9-273-2453

Norge

Box 800
1306 Sandvika
Tel: +47 40 49 66 00
Fax: +47 67 17 56 51

Österreich

Vienna, Nineteen, Mooslackengasse 17
A - 1190 Wien
Tel: +49 (0) 2104 8 33 83 0
Fax: +49 (0) 2104 833 83 79 99

Polska

ul. Marynarska 15
02-674 Warszawa
Tel.: +48 (0) 22 6070510
Fax: +48 (0) 22 6070521

Россия

ООО "Эс-Эн-Эй Юроп (РУС)"
141407 г. Химки
ул. Панфилова вл.21, стр.1
Телефон +7 (495) 221 58 51
info.ru@snaeurope.com

Portugal**SNA Europe [Industries] LDA**

R. Maria Julia M. Ramos - Junqueira
4480-254 Vila Do Conde
Tel. +351 252 650 131
Fax. +351 252 650 160

Slovenská republika**SNA Europe s.r.o.**

Karadžičova 8/A
821 08 Bratislava
Tel: +421 (0)2 5939 6124
Fax: +421 (0)2 5939 6217

SRBIJA**Vermax-alati doo**

Ul. Drage Spasić 35
11000 Beograd
Tel: +381 11 2360 500
Tel: +381 11 2360 900
Fax: +381 11 2361 147
e-mail: office@vermax.rs

Suomi**SNA Europe Oy**

PL 6580
00002 Helsinki
Finland
Tel: +358 207 433 510
Fax: +358 207 433 525

Sverige**SNA Europe Industries AB**

Box 83
SE-745 22 Enköping
Tel: +46 (0) 171-47 82 00
Fax: +46 (0) 171-47 82 38

Schweiz / Suisse

Willetstraße 10
40822 Mettmann
Tel: +49 (0) 2104 833 83 0
Fax: +49 (0) 2104 833 83 7999

Türkiye

Girne Mah. Maltepe Küçük San. Sitesi
F Blok No:19 Maltepe
Istanbul
Tel: +90 (0) 216 367 10 21
Fax: +90 (0) 216 367 11 71

Украина

«Бахко Бисов Свенска Акциеболаг»
SNA Europe [Ukraine & Moldova]
Телефон +38 067 441 16 09
офис 555, улица Армянская, 6А
Киев, Украина

United Kingdom

Moorhead Way, Bramley,
Rotherham, South Yorkshire S66 1YY
Tel: +44 (0) 1709 731731
Fax: +44 (0) 1709 731741



IRIMO

www.irimo.com

SNAEurope

IRIMO-SPA-23EURO