

**INSPIRADOS  
POR EL  
TRABAJO  
DURO**



**CATÁLOGO  
GENERAL  
HERRAMIENTAS**

**2024**

 **BELLOTA**



# ÍNDICE

## ▶ PARA LA AGRICULTURA

### PREPARACIÓN DEL TERRENO

#### AZADAS

Azadas antigiro .....	28/35
Horquillas antigiro .....	36
Azadas sin antigiro .....	37/38
Azadas ligeras .....	39

#### PALAS DE AGRICULTURA

Palas .....	40/41
Palotes .....	41/42

#### HORCAS

Horcas de heno .....	43/44
Horcas de piedra y grava .....	44
Horcas de jardín .....	45
Garabatos .....	45

#### RASTRILLOS Y ESCOBAS

Rastrillos .....	46/47
Escobas .....	48/49
Escobas de plástico .....	49

### MANTENIMIENTO DEL JARDÍN

#### HERRAMIENTAS FITO 0%

Herramientas Fito 0% mango largo .....	51
--	----

#### HERRAMIENTAS PARA EL HUERTO

Herramientas de mango largo .....	52/53
Herramientas de mango corto fibra de vidrio .....	54
Herramientas de mango corto aluminio .....	55

### GAMA ELÉCTRICA

#### CORTE Y PODA

Tijeras eléctricas .....	60
Motosierra eléctrica .....	61
Atadora eléctrica .....	61
Poda en altura .....	61

#### COMPLEMENTOS GAMA ELÉCTRICA .....

63/64
-------

### TIJERAS DE CORTE Y PODA MANUAL

#### TIJERAS MANUALES

Recolectoras Proline .....	65
Tijeras de una mano Proline .....	66
Tijeras de una mano Smart .....	67
Tijeras de una mano Classic Line .....	68
Tijeras de dos manos Proline .....	69/70
Cortasetos Proline .....	70
Tijeras de dos manos Garden Line .....	71
Cortasetos Garden Line .....	72

Cortacésped Garden Line .....	72
Repuestos de tijeras .....	73/77

#### COMPLEMENTOS .....

77
----

### OTRAS HERRAMIENTAS DE CORTE Y PODA

#### SERRUCHOS DE PODA

Serruchos de agricultura .....	80/81
Pértigas .....	82
Repuestos .....	82
Hojas de arco .....	83
Sierras de arco .....	84

#### HACHAS

Hachas para leña .....	85
Hacha de poda .....	86
Maza cuñas .....	86
Machetes .....	87/90
Guadañas .....	91
Hoces .....	92
Tajamatas .....	93

### LIMAS DE AGRICULTURA

Limas afilado .....	94/95
---------------------	-------

### HERRAMIENTAS DE HERRADOR

Escofinas .....	98/99
-----------------	-------

### ACCESORIOS PARA LA AGRICULTURA

Guantes .....	100
Rodilleras .....	100
Lubricantes .....	101
Grasas de litio .....	101

### PULVERIZADORES

Pulverizadores de mochila .....	102
Repuestos .....	102
Pulverizador de mano .....	103

### CAPAZOS .....

103
-----

### LIMPIEZA

Hidrolimpiadoras .....	108
Aspiradoras .....	108
Accesorios para hidrolimpiadoras .....	109
Accesorios para aspiradoras .....	109

## ▶ PARA LA CONSTRUCCIÓN

### ENCOFRADO

#### PALAS CONSTRUCCIÓN

Palas .....	112/114
Rascador .....	114

#### HERRAMIENTAS DESENCOFRADO

Desenconfadores .....	115
Grifas .....	115

#### RAEDERAS Y RASTRILLOS

Raederas .....	116
Rastrillos .....	116

#### TENAZAS

Tenaza Rusa .....	117
Tenaza Carpintero .....	117
Tenaza Alicatado .....	117

#### CORTAVARILLAS .....

118
-----

#### ORDENACIÓN

Porta herramientas de piel .....	119
Porta herramientas textiles .....	120
Bolsas, mochilas y trolleys .....	121
Cajas porta herramientas .....	121

### ALBAÑILERÍA

#### PALETAS

Paletas .....	122/124
Paletines .....	125
Rejunteador .....	125

#### LLANAS, TALOCHAS Y ESPÁTULAS

Llanas .....	126/128
Remolinadores .....	128
Talochas .....	129
Peines .....	130/131
Llanas de goma .....	131
Espátulas de goma .....	132
Talochas de limpieza .....	132/133
Espátulas .....	133/134
Espátulas para placa .....	134/135

#### PISTOLAS DE SILICONA .....

135
-----

### MARTILLERÍA

Mazas .....	136
Picachones .....	137
Macetas .....	138
Alcotanas .....	139
Martillos .....	140/142
Martillos sin templar .....	142
Martillos de nylon .....	143
Macetas de goma .....	143

### CINCELES

Punteros .....	144
Cinceles octogonales .....	144
Cortafíos .....	145
Pala ancha .....	145
Cinceles para el taller .....	145/146
Puntas de yesero .....	146

#### MEZCLADORAS Y VARILLAS .....

148/149
---------

#### CUBOS Y CAPAZOS

Cubos y capazos de caucho .....	150/151
Cubos y capazos de plástico .....	152/153
Gavetilla .....	153

### ALICATADO

#### CORTADORAS DE CERÁMICA Y ACCESORIOS

Cortadoras Neo .....	156
Cortadoras Lean .....	157
Cortadoras Tech .....	159
Cortadoras Pro .....	160
Cortadoras Fit .....	161
Cortadoras Pop .....	162
Cortadoras Pass .....	163
Rodeles .....	164/165

#### REPUESTOS CORTADORAS DE CERÁMICA .....

166/167
---------

#### SISTEMAS DE NIVELACIÓN Y SEPARACIÓN

Sistema Push & Level .....	169
Sistema con cuña .....	170
Crucetas .....	171
Cuñas .....	171

#### COMPLEMENTOS PARA EL ALICATADO

Cubos de alcatado y repuestos .....	172
Esponjas .....	172/173
Ventosas .....	173
Banco de trabajo .....	174
Aplanador solador .....	174
Rascador de juntas .....	174
Marcador de agujeros .....	174
Plantilla de formas .....	174

### CARPINTERÍA

#### SIERRAS Y SERRUCHOS DE CONSTRUCCIÓN

Sierras corte metal .....	175
Serruchos carpintero .....	176
Serruchos ebanista .....	176
Serruchos punta .....	176
Serruchos placa .....	177

#### FORMONES .....

177
-----

# ÍNDICE

## ▶ PARA LA CONSTRUCCIÓN

### PLACA Y YESO LAMINADO

#### HERRAMIENTAS DE CORTE



Cutters.....	178
Tijera cortachapa.....	179
Punzonadora.....	179
Remachadora.....	179

#### MEDICIÓN Y NIVELACIÓN

##### MEDICIÓN, MARCAJE Y NIVELACIÓN



Nivelación láser.....	182/183
Medición láser.....	183
Cintas métricas.....	184
Flexómetro.....	185
Lápices.....	186
Nivel tubular.....	187
Nivel fundido.....	188
Escuadra.....	188
Tiralíneas.....	189
Plomadas.....	190

#### CORTE Y PULIDO

##### DISCOS DE DIAMANTE



Discos diamante corte seco.....	191/192
Discos diamante corte húmedo.....	193

##### CORONAS DE DIAMANTE..... 194/195

##### DISCOS FLEXIBLES DE DIAMANTE PARA PULIDO..... 195

##### TACOS DE DIAMANTE PARA PULIDO..... 195

#### LIMPIEZA



Hidrolimpiadoras.....	196
Aspiradoras.....	196
Accesorios para hidrolimpiadoras.....	197
Accesorios para aspiradoras.....	197

## ▶ PARA EL TALLER

### HERRAMIENTAS PARA EL TALLER

#### DESTORNILLADORES



Boca vaciada.....	200
Boca plana.....	200
Philips.....	200
Pozidriv.....	200
Juego destornilladores.....	200

#### LLAVES



Fija.....	201
Combinada.....	202
Acodada.....	202
Tubo.....	203
Llave Stilson.....	203
Llave ajustable.....	204
Llave Allen.....	205
Llave vaso.....	206

#### ALICATES



Universal.....	207
Cortante.....	207
Manipulación.....	208
Multiapertura.....	208
Alicates Aislados.....	209
Tijeras electricista.....	209

#### CORTE Y DESBASTE

##### DISCOS ABRASIVOS



Discos abrasivos de corte.....	210/212
Discos abrasivos de desbaste.....	212

##### DISCOS DE LÁMINAS

Base de poliamida.....	213
Base de fibra de vidrio.....	214

#### CEPILLERÍA



Cepillos manuales.....	215/216
Cepillos bricolaje.....	216
Cepillos industriales circulares.....	217
Cepillos industriales taza.....	217/218
Cepillos industriales cónicos.....	218
Cepillos industriales nylon.....	219

### SUJECCIÓN



TORNILLO DE BANCO.....	220
------------------------	-----

SARGENTOS.....	220/221
----------------	---------

### LIMAS Y ESCOFINAS

#### LIMAS



Mecánico.....	222/224
Aguja.....	225

ESCOFINAS MADERA.....	226
-----------------------	-----

ESCOFINAS Y LIJADORAS PLACA.....	227
----------------------------------	-----

### ANEXO MANGOS

Para la agricultura.....	258/265
Para la construcción.....	266/270
Para el taller.....	271

## ▶ PARA TU SEGURIDAD



### CALZADO USO PROFESIONAL

Gama Classic.....	234/236
Gama Comp+.....	237/239
Gama Nonmetal.....	240
Gama Click.....	241
Gama Agro.....	242
Gama Alltrack.....	243
Gama Flex.....	244/245
Gama Street e Industry.....	246
Gama Running Classic Run.....	247
Gama Running New Run.....	248/249
Gama Core.....	250
Gama Volta.....	251
Gama Race.....	252
Gama Chef.....	253
Gama Agua.....	254

### CORDONES..... 255

### PLANTILLAS..... 256



### RODILLERAS..... 257

### ANEXO SOLUCIONES PARA EN PUNTO DE VENTA

Expositores y ganchos.....	272/274
----------------------------	---------

# LA HERRAMIENTA ESPECIALIZADA QUE POTENCIA TU TRABAJO

Con Bellota,  
la calidad está  
en el detalle.

## DURABLE

Las herramientas de Bellota PRO están diseñadas para aguantar las más duras de las situaciones. Sea cual sea el uso intensivo que le des, nunca te fallarán.

## ESPECIALISTA

Para aquellos trabajos en donde cada tarea necesita ser ejecutada a la perfección, Bellota PRO te ofrece una herramienta para cada tarea que necesites realizar.

## ALTO RENDIMIENTO

Las herramientas de Bellota Pro están diseñadas para potenciar y sacar el mayor provecho a tu esfuerzo.

# LA TALLA ÚNICA DE HERRAMIENTAS PARA TU DÍA A DÍA

Bellota Smart,  
la solución 360°  
de cada proyecto.



## DISFRUTE

Las herramientas de Bellota Smart están diseñadas para el aficionado que quiere disfrutar de su tiempo usando la herramienta.

## INFORMATIVO

Pequeños bajo-relieves y combinaciones de color que sirven como guía de uso para el usuario aficionado.

## CONFORT

Diseñadas para que el usuario se adapte fácilmente al uso de la herramienta utilizando materiales gomosos.

# PRESENTES EN CUATRO CONTINENTES

Hoy somos parte del grupo global Venanpri, que aglutina diferentes marcas de herramientas de mano, así como soluciones y componentes agrícolas.

11

MARCAS REGISTRADAS

18.000

REFERENCIAS

1.950

PERSONAS

14

PLANTAS DE FABRICACIÓN



\* 3 PLANTAS DE FABRICACIÓN

## NUESTRAS PLANTAS DE FABRICACIÓN



España  
Legazpi



España  
Olloki



España  
Zumárraga



E.E.U.U.  
California



E.E.U.U.  
Illinois



México



Colombia



Dinamarca



India

## ENCUENTRA TU DELEGACIÓN MÁS CERCANA Y CONTÁCTANOS

### ▶ EUROPA, ÁFRICA Y ASIA

#### España

Contacto: Bienvenido Calvo  
Teléfono: +34 943739000  
comercial@bellota.com  
atencionclienteBH@bellota.com

#### Francia Construcción/Industria

Contacto: Jose Gonçalves  
Móvil: +33 (0) 788796168  
jose.goncalves@bellota.com

#### Portugal

Contacto: Miguel Oitaven  
Teléfono: +351 217975412  
maria.sequeira@bellota.com

#### UK & Irlanda

Contacto: Les Ashley  
Móvil: +35 3874408077  
les.ashley@bellota.com

#### Europa Occidental

Contacto: Íñigo Alaba  
Teléfono: +34 672642738  
inigo.alaba@bellota.com

### ▶ AMÉRICA

#### EEUU, México, Centro América y Caribe

Contacto: Javier Vio  
Teléfono: +52 (55) 5393 3363  
infoventas@mex.bellota.com

#### Ecuador

Contacto: Jorge Valdez  
jorge.valdez@col.bellota.com

#### Paraguay, Uruguay y Argentina

Contacto: Sebastián Fadul  
sebastian.fadul@col.bellota.com

#### Grecia y Chipre

Contacto: Kostas Michalochristas  
Móvil: +30 6944942509  
greece@bellota.com

#### Francia Jardín/Agricultura

Contacto: Mauricio Cardarelli  
Teléfono: +34 634756134  
mauricio.cardarelli@bellota.com

#### Italia

Contacto: Alberto Lovo  
Móvil: +39 3466723561  
info@al-importagency.it

#### Países Bálticos

Contacto: Ugis Edulis  
Teléfono: +34 672642738  
bellota.baltics@bellota.com

Contacto: Gabriel Villate  
Teléfono: +34 667367324  
gabriel.villate@bellota.com

#### Perú

Contacto: Ricardo Parra  
ricardo.parra@col.bellota.com

#### Brasil y Venezuela

Contacto: Camilo Molina  
camilo.molina@col.bellota.com

#### Magreb

Contacto: Denis Bineau  
Móvil: +351 917625950  
binefr1@gmail.com

#### Francia EPI

Contacto: Mauricio Cardarelli  
Teléfono: +34 634756134  
mauricio.cardarelli@bellota.com

#### Asia, África y Oceanía

Contacto: Gabriel Villate  
Teléfono: +371 29 180 001  
gabriel.villate@bellota.com

#### Alemania

Contacto: Stefan Muth  
Teléfono: +49 1637337915  
werkzeuge@die-zwinge.de

#### Colombia

Contacto: Juan Sebastián Gómez  
juan.gomez@col.bellota.com

#### Chile y Bolivia

Contacto: Agustín Eduardo Issa  
agustin.issa@col.bellota.com

# INSPIRADOS POR EL TRABAJO DURO

En Bellota fabricamos productos inspirados en tu actitud, en tu pasión y determinación por conseguir todo aquello que quieres. Te acompañamos en el camino hacia el éxito con herramientas que nunca te fallan, con las que disfrutas y das lo mejor de ti.





# MÁS DE 100 AÑOS FABRICANDO PARA TI

## NUESTRAS RAÍCES

Patricio Echeverría, emprendedor y de carácter avanzado a su tiempo, es el creador de Bellota. Desde que tuvo uso de razón, se interesó por la fabricación en acero y el diseño de las herramientas. Creía que las que se empleaban no eran cómodas ni ofrecían la calidad deseada.

Hoy en Bellota, creamos herramientas con las que te sientes identificado. Tu actitud está en ellas. Nos inspira tu perseverancia, determinación, pasión y autoexigencia en lo que haces. Nuestras herramientas están diseñadas para ti. Para que superes los obstáculos que aparecen en tu camino. Por ello:

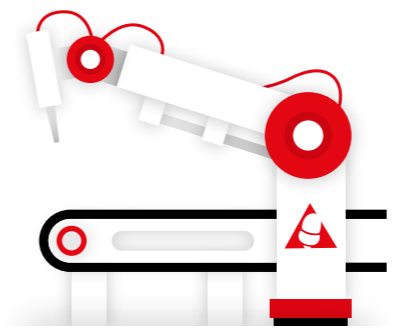

## LAS FABRICAMOS PENSANDO EN TI

Trabajamos de la mano de los mejores especialistas y estudiamos tus necesidades para hacer realidad nuestros diseños. Somos meticulosos con la calidad. Queremos ofrecerte los mejores productos para lograr tu satisfacción después de utilizarlos.



## EL MEDIO AMBIENTE NOS IMPORTA

Trasladamos nuestra conciencia responsable a los procesos de producción. Colaboramos en proyectos emprendedores con Copade y contamos con las certificaciones PEFC y FSC®, que garantizan un producto sostenible.



La marca de la gestión forestal responsable

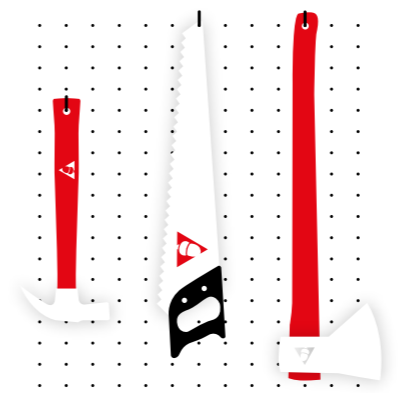

## NUNCA TE VAN A FALLAR

Desarrollamos herramientas ligeras, cómodas y con una tradición de fiabilidad. Están inspiradas en la investigación y para que respondan en los momentos que más se necesita, donde nada puede fallar y el éxito sabe a más.



# NOS PONEMOS EN TU PIEL

La pasión y la determinación forman parte de nuestra cultura. Las mismas con las que tú vives tu trabajo en tu día a día. Por eso, Bellota es para ti.

Eres nuestra fuente de inspiración, entendemos tus necesidades y te ayudamos a alcanzar tus objetivos.

Cuando sientas la satisfacción por lo que has hecho, nosotros habremos cumplido con nuestro propósito.

## HERRAMIENTAS QUE EMOCIONAN

Creemos en la comodidad y la fiabilidad, pero también en herramientas que te hagan disfrutar.

## TÚ ERES EL ALMA

Creemos en ti, en lo que tú haces con ellas. Tú pones la energía y ellas te complementan.

## EQUILIBRIO ENTRE TRADICIÓN E INNOVACIÓN

Seguimos innovando en lo que tiene sentido para ti.

## EXIGENCIA PARA LOGRAR EL ÉXITO

Creamos herramientas que no fallen, que respondan en los momentos más exigentes.

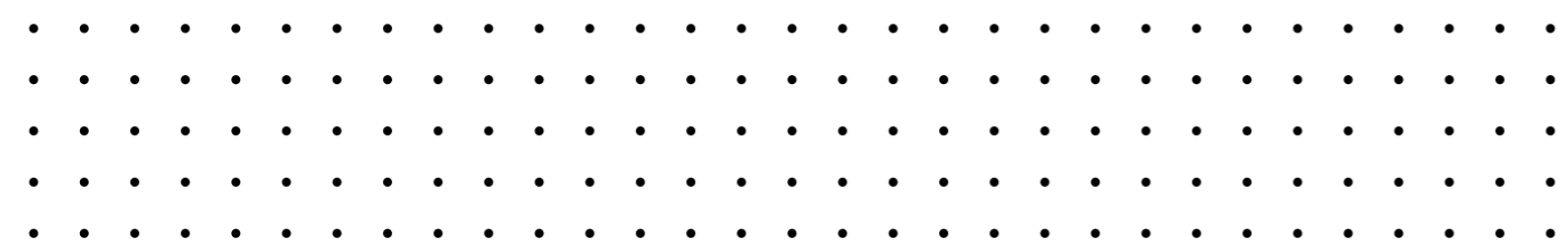

## ÍNDICE DE REFERENCIAS

REF.	PÁG.	REF.	PÁG.	REF.	PÁG.	REF.	PÁG.	REF.	PÁG.	REF.	PÁG.	REF.	PÁG.	REF.	PÁG.				
127F	89	3604	66/74	50222	189	5525	41	64579	207	820	35	CASENEO155	156	HOE332	38	M5525A	262	PRK5753P	116
127H	88	3612	67/76	50223	189	5526	40	64589	207	8241	145	CH233P	63	HOE337	38	M55562CSB	270	PRK5754P	116
128F	89	3621	65	50230	189	5550	113	64599	207	8245	145	CH238P	63	HOE338	38	M55562RSB	270	PRO72	160
1002	89	3622	65/74	50240	186	5551	113	6460	204	8251	145	CS10174C	173	HOE340	38	M5559L	269	PROBREAKMECH	167
1004	90	3623	65	50241	186	5552	114	6464	204	8255	146	CS12187MX	172	HOE344600	34	M5573A	263	PROCASE	160
1051	91	3624	65	50243	186	5556	114	6485	204	8261	146	CS12187S	172	HOE344W	34	M5573L	263	PROGUIDESCR	167
1055	88	3625	65	50244	186	5557	114	6490	203	8271	145	CSW12187	173	HOE4	29	M5573M	262	PROGUIDESQU	167
1060	90	3628	65	50245	186	5573	42	6491	204	8280	146	CSW12187E	173	HOE43	30	M5604A	263	PROJAWCOVERS	167
1071	91	3629	65	50250	190	557326	42	6492	204	8281	146	DFDIAM	195	HOE4W	29	M5604ASB	265	PROSNAPHANDLE	167
1111	93	3630	82	50251	190	5604	41	6494	205	8910	177	DFDIAMSM14	195	HOE5	29	M5604L	263	R3501	77
1116	93	3631	82	50262	135	5609	40	64956	205	8940	273	ECBA5AHP	64	HOE53	30	M5604LSB	265	R37101	102
1118	93	3642	77	50264	135	5701	116	6520	208	8942	273	ECBAECS	64	HOE58	30	M5604M	262	R371010	102
1778	87	3660	101	50271	153	5709	116	6521	208	8943	273	ECBAEPR123P	63	HOE5W	29	M5609L	263	R371011	102
1779	88	3661	101	50272	229	5710	114	6523	208	8944	273	ECBAETY	64	HOE69	30	M5701L	269	R37102	102
202	87	3662	101	50273	229	5800	172	6524	208	8952 V	273	ECBEPR1P	62	HOE72	30	M5701LSB	270	R37103	102
204	87	3700	103	50300	212	58003	172	6528	208	8970 V	273	ECHECS	62/64	HOE77	30	M5842	269	R37104	102
244	88	3710	102	50301	213	5810	132	6592	208	8975BL	270	ECHEPR	63	HOE7A	29	M5931N	267	R37105	102
2127F	89	3955	272	50302	213	5813	90	6600	203	8976BL	270	ECCHETY	64	HOE8	29	M5938	267	R37106	102
2127H	89	410	88	50310	212	5821	144	66200	202	8990CALZADON	274	ECCEC115P	62	HOE80	30	M5938SB	270	R37107	102
2128F	89	443	87	50320	212	5825	144	66210	202	8990CPOPON	274	ECCECS1P	62	HOE81P	30	M6	260	R37108	102
2460	89	448	87	50321	213	5840	274	66220	202	8990CPRON	274	ECGL12P	62	HOE81W	31	M600SB	264	R37109	102
2503	91	460	89	50322	213	5841	122	66230	202	8990EN	272	ECS1	61	HOE82	31	M6CF	260	RFA411PA	99
2506	91	465	90	50330	212	5842	122	66291	202	8990PALETAN	274	ECSE	62	HOE83A	31	M7	260	RJUNTAS	174
2509	91	4001	224	50351	214	5843	123	66292	202	8990PUAN	274	ECSEBC1P	62	HOE84	31	M7CF	260	RJUNTASR	174
2550	92	4002	225	50352	214	5844	123	6660	101	9012	43	ECSEPR1P	62	HOE85	31	M8002	267	RODEL10	164
2551	92	4003	225	50361	214	5848	123	6661	101	9013	43	ECSP1210P	61	HOE85W	31	M8004A	268	RODEL10T	164
2552	92	4004	225	50400	214	5849	123	6662	101	9014	43	ECTYWPA	64	HOE87	31	M8005	268	RODEL18	164
2560	92	4005	226	50420	213	5850	123	6663	101	9015	43	EPP1EXTP	61	HOE89A	31	M8007	268	RODEL18T	164
2561	92	4006	226	50421	213	5851	124	6700	222	9016	44	EPR123P	60	HOE90	37	M8008	268	RODEL6	164
2562	92	4007	226	50431	213	5857	124	6710	222	9024	44	EPR233P	60	HOE91	37	M8011	268	RODEL8	164
2563	92	4040	94	50441	213	5861	126	6900	121	9025	44	EPR238P	60	HOE95A	37	M8017	268	RODEL8T	164
25864	127	4041	94	50480	214	5862	127	6902500	121	9026	44	EPR140P	61	HOE96AWP	32	M8030	268	RODELXL10	165
25874	131	4042	94	50482	127	5863	127	7HDLA5BM	99	9033	45	ETY125P	61	HOEXEP	274	M8030CF	268	RODELXL10T	165
26009	118	4045	95	50501	215	5864	126	72213S3	241	9034	45	EVORUL22	165	KPGA1S	100	M8050	269	RODELXL18	165
26010	211	4050	95	50502	215	5865	127	72221S1P	240	9035	45	EXPCORT	272	L1	39	M8053	269	RODELXL18T	165
26011	211	4071	227	50503	215	5866	127	72223	247	9036	45	EXPMEZ	272	L1C1M1200	39	M8130C	263	RODELXL8	164
26102VDE	211	4072	227	50511	216	5869	128	72224KBS1P	247	9046	44	FITB	161	L2	39	M8130N	263	RODELXL8T	165
26110VDE	211	4074	227	50512	216	587003	127	72224NBS1P	247	9059	44	FITB	161	L2C2M500	39	M8131	263	RODXL10	165
26120VDE	211	4075	227	50513	216	587020	127	72226S1P	240	9104	45	FITFOAM	167	L3	39	M82512512BIM	145	RODXL8	165
26122VDE	211	4076	227	50551	216	5871	130	72227S1P	240	9114	45	FITHANDLE	167	L3C1M1200	39	M900SB	264	RODXL6	165
26150VDE	211	4077	227	50611	216	5873	130	72241	254	9145	53	FITPITCHER	167	L4	39	M901AC75	260	RODXL8	165
262	35	4078	227	50702	191	5874	130	72242S5	254	950	46	FITRKIT	167	L4C4M500	39	M901LC135	260	RUNAS3S	248
26461	206	4081	95	50703	191	5875	131	72243S5	254	951	47	FITSUPPORTS	167	L5	39	M901LR120	260	RUNBS3S	249
28018	142	4089	271	50704	192	5876	134	72294	274	952	47	FLTSP24P	133	L5C1M1200	39	M901LR120SB	260	RUNJ3S	248
2985	54	4090	271	50705	192	5877	131	72300LNTS3	236	A2503	261	FTW01B02	242	LEAN	157	M902AC75	260	RUNNS3S	249
2986	54	40907	99/263	50706	192	5879	128	72300S3	234	AC16ASL2500S	109/197	FTW01BS3	242	LEANBREAK	166	M952	261	SCR5702	116
2987	54	4093	271	50707	192	5880	128	72301LNTS3	236	AC20ASL2500S	109/197	FTW02BS1P	244	LEANCART	158	M952L	261	SCRATLEAN	166
2990	54	4101	228	50708	193	5881	129	72301S3	234	AC27ASL2500S	109/197	FTW03BS3	245	LEANGUIDE	166	MAGUJEROS	174	SP05EPR233P	63
2994	54	4102	228	50711	191	5882	129	72302S3	235	AC38ASL2500S	109/197	FTW04GS1P	244	LEANLIFT	158	MED50R	183	SP05EPR238P	63
2998	55	4103	228	50712	191	5883	129	72303S3	235	AC43ASL2500S	109/197	FTW05BOS1P	245	LEANLIFTSUC	166	MF108SBG	270	SP101ECS1210P	64
31B	88	41038	228	50713	193	5884	129	72304S1P	235	AC44ASL2500S	109/197	FTW05BYS1P	245	LEANPLIER	166	MK1HEX	149	SP18EPRP140P	64
31W	88	4104	228	50722	192	5885	129	72305S1P	235	AC45ASL2500S	109/197	FTW0790S3	245	LEANRUL	165	MK4M14	149	SP19EPRP140P	64
32L	89	4107140	229	50724	193	5886	132	72306S1P	236	AC46ASL2500S	109/197	FTW3050S1P	250	LEANSUC	166	MK5M14	149	SP23EPR123P	63
350	90	4107260	229	50732	193	5887	129	72307GJS3	239	AC49HL2400PRO	109/197	FTW4051S3	251	LEANWB	158	MK6HEX	149	SP23EPRP140P	64
368	87	4131142RAFP	99	50734	192	5888	132	72307NJS3	239	AC61HL1400	109/197	FTW4091S1P	251	LHT3085W1500	51	MK7M14	149	SP24	133
3000	55	413208RAFMB	99	50735	192	5889	129	72307S3	237	AC62HL1400	109/197	FTW5074S3	252	LHT308610W1500	51	ML1200	259	SP24EPR123P	63
3001	55	4132147RAF	99	50750	194	5890	133	72308GJS3	239	AC66HL1400	109/197	FWB	174	LHT308612W1500	51	ML500	259	SP27EPR123P	63
3003	55	4132148RAF	98	50751	194	5893	134	72308NJS3	239	AC68HL1400	109/197	GRS6664	62	LHT3087W1500	51	MN	121	SP27ECS1100P	64
3005	55	4133141RAF	99	50787	149	5894150	134	72308S3	237	AC80HL	109/197	H233P	63	LSPLATE	169	MNR	121	SP58ECS1100P	64
3006	55	413614RAF	98	50788	149	5895	134	72309GJS1P	239	AC81HL	109/197	H238P	63	SLPLIER	170	MSF3HL	109/197	SP61EPRP140P	64
3011	81	41371415RAF	98	50801	217	5896	135	72309NTS1P	238	AC82HL	109/197	H4107140	229	LSS	169	NEO100	156	SP73ECS1100P	64
3012	55	41381716RAF	98	50802	217	5897	125	72309S1P	238	AC83HL	109/197	H4107260	229	LSSCROSS	169	NEO130	156	SP79ECS1210P	64
3014	81	41391417RAF	98	50803	217	5898	131	72310GJS1P	239	AC84HL	109/197	H45	80/81	LSSKIT	169	NEO155	156	SP80ECS1210P	64
3034	49	41401418RAF	98	50804	217	5899	134	72310NTS1P	238	AC84HL1700	109/197	H5140418	178	LSSPUSH	169	NEOBASEFLO	166	SP97ECS1210P	64
33035	49	450	80	50805	218	5900	134	72310S1P	238	AC85HL	109/197	H5140525	178	LSSSTONE	169	NEOHANDLE	166	SP99ECS1210P	64
3040	48	4520	177	50806	217	5901	125	72311S3	238	AC85HL1700	109/197	H5140618	178	LSSST	169	NEOPITCHER	166	SP101ECS1	

# NOVEDADES AGRICULTURA

## ▶ LA GAMA CLASSIC CUT

Está especialmente diseñada para las personas que trabajan con fuerza y buen ritmo.

## ▶ LA GAMA EXPERT CUT

Está especialmente diseñada para las personas experimentadas que buscan un corte limpio y un movimiento fluido.



Pág. 80 / 81



## POWER CUT

HOJA DE CORTE FORJADA Y ENTERIZA PARA AUMENTAR LA DURABILIDAD.

PANTALLA O-LED CON INDICADORES  
- % BATERÍA RESTANTE  
- HISTORIAL CORTES TOTALES  
- Nº DE CORTES ACTUAL (DESDE ON)  
- CÓDIGO DE SOLUCIÓN DE ERRORES



MAYOR RAPIDEZ

MAYOR SENSIBILIDAD

MAYOR POTENCIA DE CORTE

MISMO CONSUMO

BULÓN DE ENGRASE MEJORADO QUE MANTIENE TODO EL MECANISMO ENGRASADO.

EMPUÑADURA BIMATERIAL CON MAYOR SUPERFICIE DE ELASTÓMERO QUE EVITA RESALTES MOLESTOS PARA LA MANO.

## ▶ TIJERA ELÉCTRICA EPR238

DOBLE APERTURA SELECCIONABLE



POSICIÓN 1



POSICIÓN 2

CORTE PROGRESIVO



ON



OFF

SISTEMA DE SEGURIDAD ANTI-CORTE



Pág. 60

PISTOLA DE PRESIÓN METÁLICA REFORZADA.

DEPÓSITO INTEGRADO DE DETERGENTE.

RUEDAS PARA TRANSPORTE.



FILTRO DE AGUA EXTRAÍBLE.



ASA DE TRANSPORTE.

ENROLLADOR DE MANGUERA.

## ▶ HIDROLIMPIADORA HL2400PROE 2.400W

HL1700E  
1.700W



HL1400E  
1.400W



Pág. 108 / 196

# NOVEDADES CONSTRUCCIÓN

## ► NIVEL LÁSER VERDE ESPECIAL ALICATADO NIV30360VT

- Proyecta su luz hasta 30 metros de distancia 50 metros con receptor.
- Dispone de plano bajo horizontal de nivel de 360° y los dos planos verticales de 360°. 2 intensidades.
- Dispone de imán giratorio, pinza, placa reflectora, batería cargada, cargador y maletín resistente para su transporte.



Pág. 182

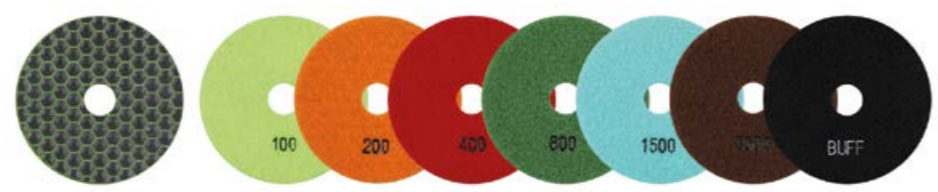

DFDIAM



DFDIAMSM14



TDIAM

## ► DISCOS FLEXIBLES DIAMANTADOS DFDIAM

## ► SOPORTE PARA DISCO FLEXIBLE DIAMANTADO DFDIAMSM

## ► TACOS DIAMANTADOS TDIAM

Pág. 195

## ► MEZCLADORA M14 1.400W

DOS VELOCIDADES

- 580 / 0-780 rpm → M14
- 0-560 / 0-760 rpm → M14110V
- 0-620 / 0-820 rpm → M16

Pág. 148

## M16 1.600 W



REFUERZOS LATERALES PARACHOQUES RESISTENTES A IMPACTOS. APOYOS ANTICAÍDAS

ARRANQUE PROGRESIVO. REGULADOR DE VELOCIDAD E INTERRUPTOR DE SEGURIDAD.

AGARRE ERGONÓMICO AMPLITUD VOLANTE. EMPUÑADURA BIMATERIAL.

## M14 1.400 W



CAMBIO RÁPIDO ESCOBILLAS DE FÁCIL ACCESO.

## ► VARILLA

TIPO K4, MÉTRICA M14. 590 MM X DIÁMETRO 120MM → M14 590 MM X DIÁMETRO 140MM → M16



## ► LEAN

Pág. 158



LEANLIFT



LEAN320



LEANWB



LEANCART

# NOVEDADES

## SEGURIDAD



### ► ZAPATO RUN RUNAS3S

Pág. 250 / 251



**COLLARÍN ERGONÓMICO Y ALMOHADILLA MESH 3D. TRANSPIRABILIDAD, ABSORCIÓN DE LA HUMEDAD Y CONFORT.**

**LENGÜETA EXTRA ACOLCHADA.**

**TALONERA REFORZADA PARA MAYOR ESTABILIDAD Y RESISTENCIA.**

**FORTITEX™ CERTIFICADO WRU: TRANSPIRABLE E HIDRÓFUGO.**

**PUNTERA DE FIBRA DE VIDRIO.**

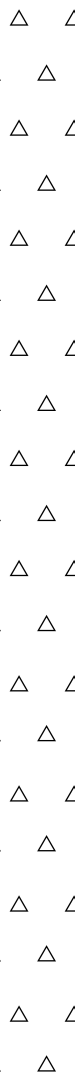

**RUNAS3S**



# RUNAS3S

**RUNB3S**



# RUNB3S

**RUNJS3S**



# RUNJS3S

**RUNNS3S**



# RUNNS3S

#### CARACTERÍSTICAS



TRANSPIRABLE E HIDRÓFUGO



LIGEREZA



LOOK DEPORTIVO



ANTIFATIGA



100% NO METÁLICA

#### USOS



INSTALADOR REFORMISTA / ALBAÑIL



INDUSTRIA LIGERA



TRANSPORTISTA ALMACENISTA



CARPINTERO MECÁNICO



DEPENDIENTE

#### CATEGORÍA DE SEGURIDAD



S3S  
MÁXIMA PROTECCIÓN TEXTIL



SR  
MÁXIMA CERTIFICACIÓN ANTIDSLIZAMIENTO



FO  
RESISTENCIA A LOS HIDROCARBUROS



CI  
PROTECCIÓN FRENTE AL FRÍO



ESD  
MÁXIMA DESCARGA ELECTRODOMÉSTICA



Herramientas que  
harán crecer tus frutos  
cosecha a cosecha

**PARA  
LA AGRICULTURA**

# ▶ AZADA ANTIGIRO



## ▶ NI GIRA NI SE AFLOJA

LA CABEZA Y EL MANGO SERÁN UNO.

## ▶ DURA MÁS

LA UNIÓN RESISTE AL USO INTENSIVO, AL PASO DEL TIEMPO Y A LOS GOLPES FALLIDOS.



## ▶ MANGO FABRICADO EN UNA SOLA PIEZA

- ▶ El plástico inyectado a gran presión se introduce por los poros de la madera.
- ▶ La unión es inseparable, resistente al calor y a la humedad.

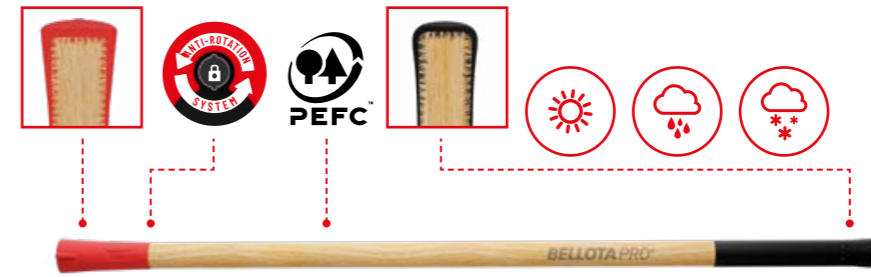

## ▶ ELIGE LA COMBINACIÓN PERFECTA

Elegir un mango para tu azada será más sencillo. Elegirás entre 3 medidas de cabezas con ANTI-ROTATION SYSTEM.

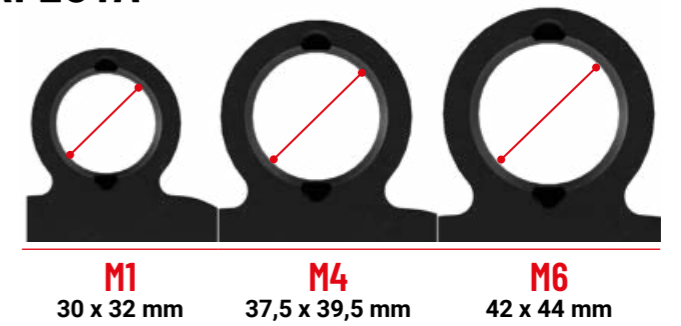

Combínala con uno de estos mangos con ANTI-ROTATION SYSTEM.



¡Y ya la tienes!  
Una apuesta segura.

M1	M4	M6
30 x 32 mm	37,5 x 39,5 mm	42 x 44 mm
M1 -1.000 mm	M4 -1.000 mm	M6 -1.000 mm
M1 -1.200 mm	M4 -1.200 mm	M6 -1.200 mm
M1 -1.400 mm	M4 -1.400 mm	M6 -1.400 mm

## ▶ O PONLE TU PROPIO MANGO

Las cabezas de azada con ANTIROTATION SYSTEM son compatibles con cualquier mango.

Las hendiduras te permitirán utilizar tus cuñas y paños habituales con más facilidad.

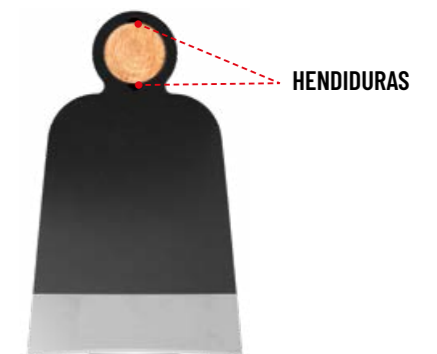

# AZADAS



Ref. HOE85BP

Filo por detrás para mejor inserción en la tierra.

## AZADAS ANTIGIRO

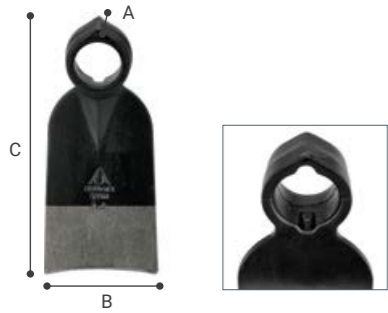

AZADA 1

REF.	€	8 41 4299	g	A mm	B mm	C mm	M
HOE1AP	19,06	694772	12	380	30	80	175 M1
HOE1BP	19,66	694734	12	430	30	90	200 M1
HOE1CP	21,76	694697	12	650	42	105	220 M4

Para labores de detalle.

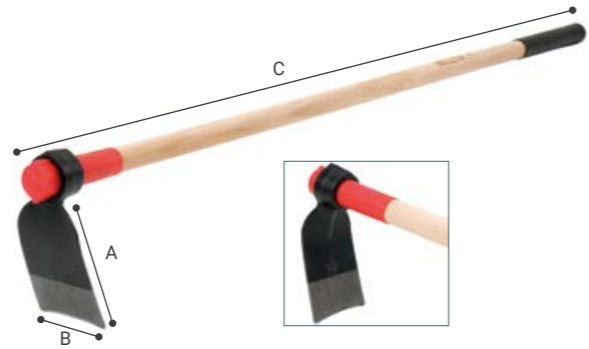

AZADA CON MANGO 1

REF.	€	8 41 4299	g	A mm	B mm	C mm	M
HOE1AW1200AP	30,54	694758	2	1.182	168	80	1.200 M1
HOE1BW1200AP	31,17	694710	2	1.137	188	89	1.200 M1



AZADA 2

REF.	€	8 41 4299	g	A mm	B mm	C mm	M
HOE2AP	25,08	694673	12	810	40	140	220 M4
HOE2BP	25,40	694659	12	1.000	40	145	245 M4



AZADA 3

REF.	€	8 41 4299	g	A mm	B mm	C mm	M
HOE3AP	29,29	694635	12	970	42	180	220 M4
HOE3BP	29,84	695007	12	940	40	190	240 M4

Remover la tierra, escardar, binar.



AZADA 4

REF.	€	8 41 4299	g	A mm	B mm	C mm	M
HOE4AP	28,99	694598	12	1.100	42	165	250 M4
HOE4BP	30,66	694574	12	1.260	50	180	270 M4

Para hacer caballones.



AZADA 5

REF.	€	8 41 4299	g	A mm	B mm	C mm	M
HOE5P	37,61	694536	12	1.430	40	120	290 M6

Para cavar y hacer zanjas.



AZADA 7

REF.	€	8 41 4299	g	A mm	B mm	C mm	M
HOE7AP	19,11	694499	12	370	30	50	195 M1

Azada pequeña para labores de detalle.



AZADA 10

REF.	€	8 41 4299	g	A mm	B mm	C mm	M
HOE10AP	33,24	694413	12	1.250	38	145	270 M4



AZADA CON MANGO 4

REF.	€	8 41 4299	g	A mm	B mm	C mm	M
HOE4BW1400AP	47,90	694550	2	2.260	248	179	1.400 M4

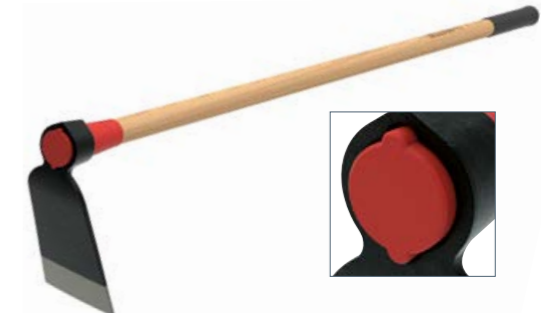

AZADA CON MANGO 5

REF.	€	8 41 4299	g	A mm	B mm	C mm	M
HOE5W1400AP	56,96	694512	2	2.432	269	118	1.400 M6



AZADA 8

REF.	€	8 41 4299	g	A mm	B mm	C mm	M
HOE8AP	21,92	694475	12	590	35	80	225 M4
HOE8BP	22,48	694451	12	710	35	100	240 M4
HOE8CP	26,65	694437	12	930	35	120	260 M4



AZADA 11

REF.	€	8 41 4299	g	A mm	B mm	C mm	M
HOE11AP	39,44	694390	12	1.800	50	120	320 M6

Para cavar y plantar.





AZADA 43

REF.	€	8 41 4299	g	A mm	B mm	C mm	M
HOE430P	36,75	694376	12	1.370	75	45	295 M6
HOE43BP	40,39	694352	12	1.520	60	185	305 M6

Para hacer caballones, trasladar tierra y vaciar.



AZADA 58

REF.	€	8 41 4299	g	A mm	B mm	C mm	M
HOE580P	31,36	694314	12	1.050	50	160	265 M4
HOE58AP	37,01	694291	12	1.360	60	180	285 M4

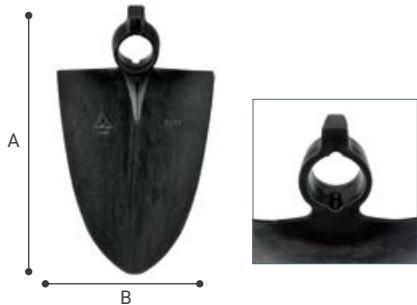

AZADA 72

REF.	€	8 41 4299	g	A mm	B mm	C mm	M
HOE72AP	26,85	694239	12	800	115	170	295 M4
HOE72BP	29,05	694215	12	840	33	180	310 M4
HOE72CP	30,84	694192	12	1.150	55	200	330 M4
HOE72DP	34,53	694178	12	1.430	50	220	360 M4

Modelo Galicia.



AZADA 80

REF.	€	8 41 4299	g	A mm	B mm	C mm	M
HOE80AP	29,05	694130	12	850	34	160	250 M4
HOE80BP	29,74	694116	12	970	34	170	250 M4
HOE80EP	34,06	694093	12	1.340	55	190	280 M4
HOE80HP	38,12	694079	12	1.370	60	200	310 M4



AZADA 53

REF.	€	8 41 4299	g	A mm	B mm	C mm	M
HOE53BP	32,62	694338	12	1.100	55	190	305 M4
HOE53AP	29,23	695038	12	1.100	55	190	305 M4

Para cavar y hacer surcos.



AZADA 69

REF.	€	8 41 4299	g	A mm	B mm	C mm	M
HOE69AP	36,36	694277	12	1.350	28	165	360 M4
HOE69BP	40,10	694253	12	1.660	35	180	420 M6

Modelo Navarra.



AZADA 77

REF.	€	8 41 4299	g	A mm	B mm	C mm	M
HOE77DP	39,77	694154	6	1.520	85	225	350 M4

Para el cultivo de patatas.



AZADA 81

REF.	€	8 41 4299	g	A mm	B mm	C mm	M
HOE81000P	26,92	694055	12	820	60	165	250 M4
HOE8100P	28,86	694031	12	930	40	180	270 M4
HOE81AP	34,34	693997	12	1.210	30	220	305 M4
HOE810P	30,22	694017	12	1.000	40	200	280 M4



AZADA CON MANGO 81

REF.	€	8 41 4299	g	A mm	B mm	C mm	M
HOE81000W1000AP	38,03	693973	2	1.680	232	168	1.000 M4
HOE81000W1200AP	40,05	704112	2	1.760	232	168	1.200 M4
HOE810W1200AP	43,49	693935	2	2.030	261	200	1.200 M4



AZADA 83

REF.	€	8 41 4299	g	A mm	B mm	C mm	M
HOE83AP	30,96	693898	12	1.040	38	140	260 M4



AZADA 85

REF.	€	8 41 4299	g	A mm	B mm	C mm	M
HOE85AP	23,28	693799	12	700	34	115	220 M4
HOE85BP	23,80	693775	12	740	34	125	230 M4
HOE85CP	26,71	693737	12	820	34	135	240 M4



AZADA 82

REF.	€	8 41 4299	g	A mm	B mm	C mm	M
HOE82BP	24,85	693911	12	750	45	140	235 M4



AZADA 84

REF.	€	8 41 4299	g	A mm	B mm	C mm	M
HOE84AP	24,57	693874	12	690	42	135	210 M4
HOE84BP	26,05	693850	12	800	42	150	210 M4
HOE84CP	26,19	693836	12	840	45	140	225 M4



AZADA CON MANGO 85

REF.	€	8 41 4299	g	A mm	B mm	C mm	M
HOE85BW1200AP	37,05	693751	2	1.670	206	122	1.200 M4
HOE85BW1000AP	34,71	693713	2	1.590	206	122	1.000 M4



AZADA 87

REF.	€	8 41 4299	g	A mm	B mm	C mm	M
HOE87BP	22,77	693683	12	1.070	40	150	260 M4
HOE87CP	25,57	693669	12	1.190	38	165	280 M4
HOE87DP	28,13	693645	12	1.340	60	180	300 M4
HOE87EP	31,36	693621	12	1.500	50	185	320 M4
HOE87FP	34,64	693607	6	1.810	55	195	350 M6
HOE87GP	35,93	693584	6	1.990	90	240	365 M6

Para el cultivo de espárragos.



AZADA 89

REF.	€	8 41 4299	g	A mm	B mm	C mm	M
HOE89AP	24,20	693560	12	690	45	120	200 M4



▶ CÀVEC MALLORQUÍ HOE96AWP

REF.	€	8 41 4299	g	A mm	B mm	C mm	M
HOE96AWP	16,30	676334	6	1.475	230	285	740

Càvec Mallorquí.



▶ AZADA 182

REF.	€	8 41 4299	g	A mm	B mm	C mm	M
HOE182P	19,20	693386	12	400	29	120	210

Para cavar surcos, limpieza de viña.



▶ AZADA CON MANGO 228

REF.	€	8 41 4299	g	A mm	B mm	C mm	M
HOE228AW1200AP	36,80	693348	2	1.167	268	80	1.200
HOE228AW400P	28,38	695052	2	660	268	80	400
HOE228AW1000AP	35,49	693263	2	1.090	268	80	1.000

Para labores de jardinería. Herramienta de doble uso: azada para remover la tierra y horquilla para limpiar y arrancar raíces.



▶ AZADA CON MANGO 242

REF.	€	8 41 4299	g	A mm	B mm	C mm	M
HOE2420W335P	20,94	692969	3	475	137	54	335
HOE242AW360P	22,96	692945	3	565	165	70	360

Para plantar parterres y zonas de rocalla.

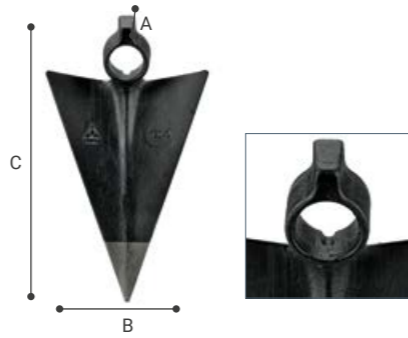

▶ AZADA 150

REF.	€	8 41 4299	g	A mm	B mm	C mm	M
HOE150AP	29,59	693423	12	950	35	190	330
HOE150CP	34,96	693409	12	1.170	50	230	355

Para cavar surcos.



▶ AZADA 228

REF.	€	8 41 4299	g	A mm	B mm	C mm	M
HOE228AP	25,02	693362	12	490	35	75	270
HOE228BP	26,43	693324	12	540	45	80	295
HOE228CP	28,46	693300	12	640	50	85	320
HOE228DP	32,13	693287	12	770	50	100	330

Para labores de jardinería. Herramienta de doble uso: azada para remover la tierra y horquilla para limpiar y arrancar raíces.



▶ AZADA 242

REF.	€	8 41 4299	g	A mm	B mm	C mm	M
HOE2420P	17,49	693003	12	230	35	55	140
HOE242AP	19,25	692983	12	400	29	70	170

Para plantar parterres y zonas de rocalla.



▶ AZADA 229

REF.	€	8 41 4299	g	A mm	B mm	C mm	M
HOE229AP	27,02	693249	12	640	32	110	310

Para labores de jardinería. Herramienta de doble uso: azada pico para plantar y horquilla para limpiar y arrancar raíces.



▶ AZADILLA 230

REF.	€	8 41 4299	g	A mm	B mm	C mm	M
HOE230AP	22,84	693201	12	470	30	70	260
HOE230BP	24,96	693188	12	530	32	75	290

Para labores de jardinería. Herramienta de doble uso: azada para remover la tierra y lanza para preparar la tierra para plantar.



▶ AZADILLA 232

REF.	€	8 41 4299	g	A mm	B mm	C mm	M
HOE232AP	17,14	693126	12	320	29	70	160
HOE232BP	18,56	693102	12	360	29	75	175
HOE232CP	19,77	693089	12	400	29	80	190

Modelo pequeño, para zonas de rocalla.



▶ AZADA CON MANGO 325

REF.	€	8 41 4299	g	A mm	B mm	C mm	M
HOE325800W1200AP	35,85	692723	2	1.790	243	120	1.200

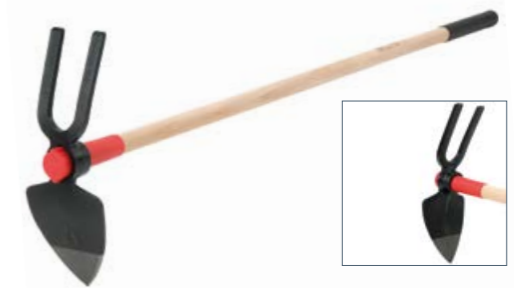

▶ AZADILLA CON MANGO 229

REF.	€	8 41 4299	g	A mm	B mm	C mm	M
HOE229AW1200AP	38,89	693225	2	1.257	301	115	1.200

Para labores de jardinería. Herramienta de doble uso: azada pico para plantar y horquilla para limpiar y arrancar raíces.



▶ AZADILLA CON MANGO 230

REF.	€	8 41 4299	g	A mm	B mm	C mm	M
HOE230AW400P	28,56	693164	2	670	252	71	400
HOE230AW1000AP	33,39	693140	2	1.080	252	71	1.000
HOE230AW1200AP	34,27	695076	2	1.147	252	71	1.200

Para labores de jardinería. Herramienta de doble uso: azada para remover la tierra y lanza para preparar la tierra para plantar.



▶ AZADILLA CON MANGO 232

REF.	€	8 41 4299	g	A mm	B mm	C mm	M
HOE232AW400P	22,46	693065	2	555	155	70	400

Modelo pequeño, para zonas de rocalla.



▶ AZADA 326

REF.	€	8 41 4299	g	A mm	B mm	C mm	M
HOE326P	27,02	692709	12	550	30	170	195



▶ AZADA 320

REF.	€	8 41 4299	g	A mm	B mm	C mm	M
HOE320P	36,15	692808	12	1.210	55	180	300 M4

Modelo Rabiosa, especial espárragos.



▶ AZADA 325

REF.	€	8 41 4299	g	A mm	B mm	C mm	M
HOE325800P	20,96	692785	12	900	60	120	245 M4
HOE3251000P	24,20	692761	12	1.030	45	140	270 M4
HOE3251200P	26,26	692747	12	1.180	38	160	290 M4



▶ AZADÓN 801

REF.	€	8 41 4299	g	A mm	B mm	C mm	M
801-0	58,86	114300	6	2.210	85	85	400

Herramienta de doble uso: Hacha y azada. Labores forestales, limpieza y corte de raíces.



▶ AZADÓN 805

REF.	€	8 41 4299	g	A mm	B mm	C mm	M
805-A	57,18	114508	6	2.100	85	65	395 M6

Herramienta de doble uso: Hacha y azada. Labores forestales, limpieza y corte de raíces.



▶ AZADA 327

REF.	€	8 41 4299	g	A mm	B mm	C mm	M
HOE327AP	28,39	692686	12	850	35	185	230 M4



▶ AZADA 328

REF.	€	8 41 4299	g	A mm	B mm	C mm	M
HOE328BP	28,62	692662	12	960	40	220	260 M4

Para el cultivo de tubérculos. Adecuada para trabajar suelos con gravilla o pequeñas piedras.



▶ AZADÓN 820

REF.	€	8 41 4299	g	A mm	B mm	C mm	M
820	52,32	114706	6	1.500	85	65	370 M6

Herramienta de doble uso: Hacha y azada. Labores forestales, limpieza y corte de raíces.



▶ ALMOCAFRE 262

REF.	€	8 41 4299	g	A mm	B mm	C mm	M
262	37,49	113105	12	694	270	170	250

Para escardar, limpiar la tierra, plantar y trasplantar plantas pequeñas.



▶ AZADA 344

REF.	€	8 41 4299	g	A mm	B mm	C mm	M
HOE344600P	21,45	692501	12	560	35	75	300 M1

Herramienta múltiple: azada, trabajar la tierra en superficie, quitar malas hierbas, horquilla para arrancar raíces y romper la costra superficial.



▶ AZADA CON MANGO 344

REF.	€	8 41 4299	g	A mm	B mm	C mm	M
HOE344600W1000AP	30,37	692488	2	1.150	297	76	1.000 M1

Herramienta múltiple: azada, trabajar la tierra en superficie, quitar malas hierbas, horquilla para arrancar raíces y romper la costra superficial.



▶ ALMOCAFRE 322

REF.	€	8 41 4299	g	A mm	B mm	C mm	M
322-A	29,83	114003	12	450	130	120	365

Para escardar, limpiar la tierra, plantar y trasplantar plantas pequeñas.

## HORQUILLAS ANTIGIRO

- Fabricadas con Acero Especial Bellota.
- Forjadas en una sola pieza, irrompibles.
- Tratamiento térmico 3+ para alargar la vida útil de la herramienta: no se rompe, no se deforma, no se desgasta.
- Pulida y afilada para facilitar la introducción en la tierra.
- Pintura y barniz especiales para evitar la oxidación de la herramienta.

### Usos:

- Para airear la tierra y sacar tubérculos.

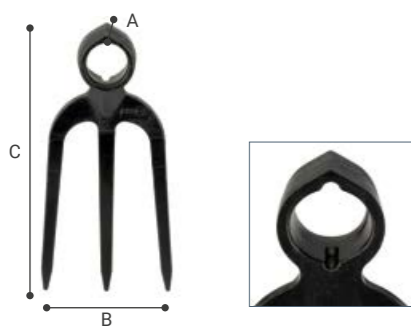

► HORQUILLA 1020

REF.	€	8 41 4299	g	A mm	B mm	C mm	M
HFK1020AP	31,75	710793	12	910	40	125	255 M4

Para airear la tierra y sacar tubérculos. Para uso en terreno pedregoso.



► HORQUILLA 1002

REF.	€	8 41 4299	g	A mm	B mm	C mm	M
HFK1002AP	51,98	710694	6	1.730	90	135	320 M6

Para airear la tierra y sacar tubérculos.



► HORQUILLA 1018

REF.	€	8 41 4299	g	A mm	B mm	C mm	M
HFK1018P	50,06	710779	12	1.060	75	125	325 M4

Para airear la tierra y sacar tubérculos.

## AZADAS SIN ANTIGIRO



► AZADA 90

REF.	€	8 41 4299	g	A mm	B mm	C mm	M
HOE90B	36,86	693546	12	920	60	120	320 M4

Doble uso, romper tierra dura y remover.

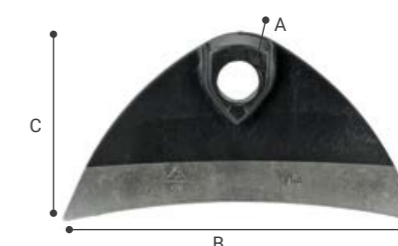

► AZADA 91

REF.	€	8 41 4299	g	A mm	B mm	C mm	M
HOE91A	35,24	693522	12	1.120	30	320	160 M4
HOE91B	42,56	693508	12	1.400	20	390	190 M4

Para el cultivo del plátano.



► AZADA 95

REF.	€	8 41 4299	g	A mm	B mm	C mm	M
HOE95A	24,44	710632	12	930	40	180	270 M6

Modelo Marruecos.



► AZADA 108

REF.	€	8 41 4299	g	A mm	B mm	C mm	M
HOE108A	34,96	693461	12	930	40	180	270 M108

Para el cultivo de espárragos.



► AZADA 127

REF.	€	8 41 4299	g	A mm	B mm	C mm	M
HOE127A	32,22	693447	12	860	110	155	290 M127

Modelo Cataluña.



► AZADA 252

REF.	€	8 41 4299	g	A mm	B mm	C mm	M
HOE252A	27,44	708592	12	740	40	190	200 M6
HOE252B	29,29	708622	12	900	40	200	210 M6

Modelo África.



AZADA 263

REF.	€	8 41 4299	g	A mm	B mm	C mm	M
HOE263A	29,95	708448	12	1.020	45	295	M6
HOE263B	31,51	708462	12	910	45	325	M6
HOE263C	36,75	708486	12	1.470	45	350	M6
HOE263D	37,88	708509	6	1.610	45	355	M6



AZADA 332

REF.	€	8 41 4299	g	A mm	B mm	C mm	M
HOE332A	34,42	692648	12	1.340	50	215	M332EM
HOE332B	36,17	692624	12	1.400	45	240	M332EM
HOE332D	39,23	692600	6	1.880	50	280	M332EM

Modelo Árabe.



AZADA 338

REF.	€	8 41 4299	g	A mm	B mm	C mm	M
HOE3380	24,34	692563	12	1.040	40	200	M4
HOE338A	25,38	692549	12	1.200	40	215	M4

Modelo Grecia.



AZADÓN 240

REF.	€	8 41 4299	g	A mm	B mm	C mm	M
HOE240	39,16	693041	12	680	70	75	M1

Pulaski, uso forestal. Herramienta múltiple, cortar, raspar y cavar.



AZADA 337

REF.	€	8 41 4299	g	A mm	B mm	C mm	M
HOE337A	24,70	692587	12	1.180	40	190	M4

Modelo Grecia.



AZADA 340

REF.	€	8 41 4299	g	A mm	B mm	C mm	M
HOE340A	26,65	692525	12	850	50	168	M4

Modelo Grecia.

AZADAS LIGERAS

AZADA LIGERA AIR L1CM1200

REF.	€	8 41 4299	g	A mm	B mm	C mm	M
L1CM1200	29,42	651706	2	1.210	190	180	1.200 ML1200

Para remover la tierra, escardar y binar. Hoja ancha y corta para labores generales de mantenimiento. Permite trabajar en una posición erguida y evitar lesiones de espalda.

AZADA LIGERA AIR L2CM500

REF.	€	8 41 4299	g	A mm	B mm	C mm	M
L2CM500	27,81	651751	2	600	174	110	500 ML500

Para remover la tierra, escardar, binar y labores de detalle. Hoja corta y estrecha para labores específicas de mantenimiento. Permite el uso con una mano para realizar acabados de detalles.

AZADA LIGERA AIR L3CM1200

REF.	€	8 41 4299	g	A mm	B mm	C mm	M
L3CM1200	34,17	651799	2	1.230	240	140	1.200 ML1200

Para cavar y hacer zanjas. Hoja larga y ancha para labores de construcción y preparación de la tierra. Permite trabajar en una posición erguida y evitar lesiones de espalda.

AZADA LIGERA AIR L4CM500

REF.	€	8 41 4299	g	A mm	B mm	C mm	M
L4CM500	32,58	651836	2	690	240	100	500 ML500

Para cavar y hacer zanjas. Hoja larga y estrecha para hacer zanjas estrechas y acceder a zonas difíciles. Permite el uso con una mano para acabados de detalles.

AZADA LIGERA AIR L5CM1200

REF.	€	8 41 4299	g	A mm	B mm	C mm	M
L5CM1200	32,58	651881	2	1.400	240	180	1.200 ML1200

Para hacer caballones. Hoja extra-ancha y larga para tareas más generales que impliquen movimiento y traslado de tierra. Permite trabajar en posición erguida y evitar lesiones de espalda.

REPUESTOS



CABEZAS DE REPUESTOS AZADA LIGERA AIR

REF.	€	8 41 4299	g	A mm	B mm
L1	20,99	651683	3	Hoja ancha y corta	620 40 180
L2	19,54	651737	3	Hoja corta y estrecha	370 35 110
L3	25,75	651775	3	Hoja larga y ancha	640 58 140
L4	22,91	651812	3	Hoja larga y estrecha	460 58 100
L5	24,64	651850	3	Hoja extra-ancha y larga	810 58 180

# PALAS DE AGRICULTURA

## PALAS

### Palas forjadas:

- Fabricadas con Acero Especial Bellota, en una sola pieza, irrompibles.
- Mangos de madera de haya barnizados, ligeros y de tacto agradable. Certificados PEFC.

### Palas de chapa:

- Fabricadas con Acero Especial Bellota.
- Tratamiento térmico 3+ para alargar la vida útil de la herramienta: no se rompe, no se deforma, no se desgasta.
- Dos tipos de mangos:
  - Mangos de madera de haya barnizados, ligeros y de tacto agradable. Certificados PEFC.
  - Mangos de fibra de vidrio huecos. Modelos largos con dos foams para mejor agarre. Modelos anilla extra-ancha con elastómero para mejor agarre.

### Palas de aluminio:

- Hoja de aluminio de alta calidad: muy ligeras y fáciles de limpiar.
- Gran elasticidad y resistencia a las deformaciones.
- Cubo muy resistente, remachado, para asegurar una perfecta unión entre cabeza y mango.
- Mangos de madera de haya barnizados, ligeros y de tacto agradable. Certificados PEFC.

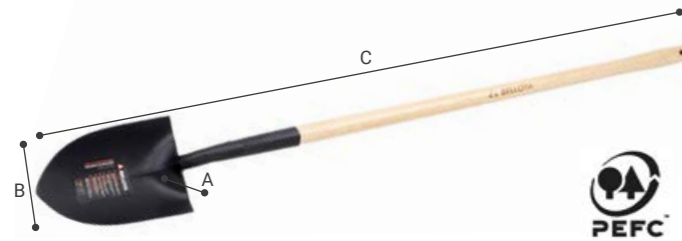

► PALA FORJADA 5609

REF.	€	8 41 4299	g	A mm	B mm	C mm	M
5609 ML	58,56	502305	2	2.230	120	190	1.240 M5609L

Uso forestal: para sofocar fuego, cortar pequeñas ramas y escudo facial.



► PALA PUNTA DE CHAPA MANGO LARGO FIBRA DE VIDRIO 3100

REF.	€	8 41 4299	g	A mm	B mm	C mm	
3100MFV	33,93	533866	6	2.180	130	230	1.460

Curvatura ideal para evacuar la tierra. Diseño reforzado para facilitar su inserción en la tierra.



► PALA PUNTA DE CHAPA MANGO ANILLA FIBRA DE VIDRIO 3103

REF.	€	8 41 4299	g	A mm	B mm	C mm	
3103 MFVA	25,21	550726	2	2.280	130	230	1.240

Para cavar y trasplantar. Diseño reforzado para facilitar su inserción en la tierra.



► PALA CUADRADA DE CHAPA MANGO ANILLA FIBRA DE VIDRIO 3104

REF.	€	8 41 4299	g	A mm	B mm	C mm	
3104 MFVA	28,00	550740	2	2.140	100	240	1.010

Para trasvasar tierra y estiércol. Diseño reforzado para facilitar su inserción en la tierra.



► PALA MULTIUSO DE CHAPA MANGO ANILLA 5526

REF.	€	8 41 4299	g	A mm	B mm	C mm	
5526	11,36	371819	6	940	50	150	680

Para cavar y trasvasar tierra arena y nieve. Ligera, práctica y manejable.



► PALA DE ALUMINIO MANGO ANILLA 5520

REF.	€	8 41 4299	g	A mm	B mm	C mm	M
5520 MA	48,60	503296	6	1.960	180	360	1.280 M5520A M5520L



► PALA DE ALUMINIO MANGO LARGO 5520

REF.	€	8 41 4299	g	A mm	B mm	C mm	M
5520 ML	50,54	503104	6	2.000	200	375	1.600 M5520A M5520L



► PALA DE ALUMINIO MANGO ANILLA 5522

REF.	€	8 41 4299	g	A mm	B mm	C mm	M
5522 MA	41,09	103182	6	1.630	200	325	1.240 M5520A M5520L

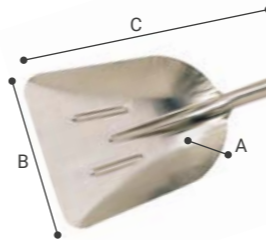

► PALA DE ALUMINIO 5522

REF.	€	8 41 4299	g	A mm	B mm	C mm	M
5522 SM	28,47	674132	54	780	120	330	510 M5520A M5520L



► PALA DE ALUMINIO MANGO ANILLA 5525

REF.	€	8 41 4299	g	A mm	B mm	C mm	M
5525 MA	34,07	336696	6	1.010	130	230	990 M5525A

## PALOTES

### Palote forjado:

- Fabricadas con Acero Especial Bellota, en una sola pieza, irrompibles.
- Mangos de madera de haya barnizados, ligeros y de tacto agradable. Certificados PEFC.

### Palotes de chapa:

- Fabricadas con Acero Especial Bellota.
- Tratamiento térmico 3+ para alargar la vida útil de la herramienta: no se rompe, no se deforma, no se desgasta.
- Dos tipos de mangos:
  - Mangos de madera de haya barnizados, ligeros y de tacto agradable. Certificados PEFC.
  - Mangos de fibra de vidrio huecos. Modelos largos con dos formas para mejor agarre. Modelos anilla extra-ancha con elastómero para mejor agarre.

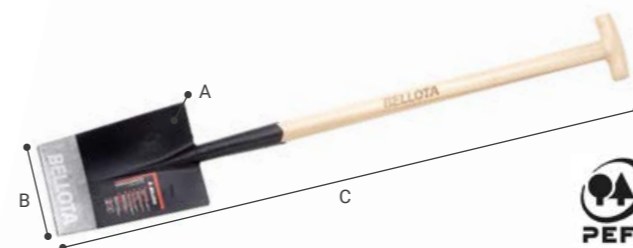

► PALOTE FORJADO MANGO MULETA 5604

REF.	€	8 41 4299	g	A mm	B mm	C mm	M
5604-24 MM	63,63	125207	6	2.180	36	180	1.040 M5604M M5604A M5604L M5604ASB M5604LSB
5604-26 MM	65,25	125603	6	2.140	40	195	1.040 M5604M M5604A M5604L M5604ASB M5604LSB

\* Durante este año las unidades de envase cambiarán de 6 a 2.



► PALOTE FORJADO MANGO ANILLA 5604

REF.	€	8 41 4299	g	A mm	B mm	C mm	M
5604-24 MA	70,02	125306	4	2.290	42	180	1.040 M5604M M5604A M5604L M5604ASB M5604LSB
5604-26 MA	72,33	125702	4	2.580	50	190	1.060 M5604M M5604A M5604L M5604ASB M5604LSB

\* Durante este año las unidades de envase cambiarán de 4 a 2.



▶ PALOTE FORJADO MANGO LARGO 5604

REF.	€	g	A mm	B mm	C mm	M		
5604-24 ML	66,42	125405	6	1.990	55	180	1.270	M5604M M5604A M5604L M5604ASB M5604LSB
5604-26 ML	66,17	125801	6	2.380	42	190	1.320	M5604M M5604A M5604L M5604ASB M5604LSB

\* Durante este año las unidades de envase cambiarán de 6 a 2.



▶ PALOTE DE CHAPA MANGO LARGO FIBRA DE VIDRIO 3101MFV

REF.	€	g	A mm	B mm	C mm		
3101MFV	33,93	533880	6	1.835	130	180	1.500

Para trasplantar, recortar y perfilar el terreno. Diseño reforzado para facilitar su inserción en la tierra.



▶ PALOTE DE CHAPA MANGO MULETA 5573

REF.	€	g	A mm	B mm	C mm	M		
5573-26 MM	30,80	124804	6	1.670	50	195	955	M5604M M5604A M5604L M5604ASB M5604LSB

\* Durante este año las unidades de envase cambiarán de 6 a 2.



▶ PALOTE DE CHAPA MANGO ANILLA 5573

REF.	€	g	A mm	B mm	C mm	M		
5573-26 MA	34,33	124903	4	2.110	40	190	1.090	M5604M M5604A M5604L M5604ASB M5604LSB

\* Durante este año las unidades de envase cambiarán de 4 a 2.



▶ PALOTE DE CHAPA MANGO LARGO 5573

REF.	€	g	A mm	B mm	C mm	M		
5573-26 ML	30,30	125009	6	1.940	40	190	1.230	M5604M M5604A M5604L M5604ASB M5604LSB

\* Durante este año las unidades de envase cambiarán de 6 a 2.



▶ PALOTE CHAPA 5573

REF.	€	g	A mm	B mm	C mm	M		
5573-26 SM	21,69	155198	12	1.080	40	200	350	M5604M M5604A M5604L M5604ASB M5604LSB

# HORCAS

## HORCAS DE HENO

- Fabricadas con Acero Especial Bellota.
- Forjadas en una sola pieza, irrompibles.
- Tratamiento térmico 3+ para alargar la vida útil de la herramienta: no se rompe, no se deforma, no se desgasta.
- Dientes afilados y templados en toda su longitud.
- Pintura especial para evitar la oxidación de la herramienta.
- Mangos de madera de fresno barnizados, ligeros y de tacto agradable. Certificados PEFC.

### Usos:

- Para trasladar heno y estiércol.
- Para manipular fardos.



▶ HORCA 901-2

REF.	€	g	A mm	B mm	C mm	L mm	M		
901-2	17,60	156119	12	460	170	150	380	30	M901LR120 M901LC135 M901AC75 M901LR120SB

Para manipular fardos.



▶ HORCA 901-3

REF.	€	g	A mm	B mm	C mm	L mm	M		
901-3	20,69	156126	12	610	170	200	390	32	M901LR120 M901LC135 M901AC75 M901LR120SB

Para recoger heno y estiércol. Manipular fardos.



▶ HORCA 901-3A

REF.	€	g	A mm	B mm	C mm	L mm	M		
901-3A	27,65	156133	12	810	90	280	520	41	M901LR120 M901LC135 M901AC75 M901LR120SB

Para recoger heno y estiércol. Manipular fardos. Mayor anchura de trabajo.



▶ HORCA 901-4

REF.	€	g	A mm	B mm	C mm	L mm	M		
901-4	21,13	156157	12	900	39	225	485	32	M901LR120 M901LC135 M901AC75 M901LR120SB

Para recoger heno y estiércol.



▶ HORCA 901-3B

REF.	€	g	A mm	B mm	C mm	L mm	M		
901-3B	35,89	156140	6	980	270	270	480	41	M901LR120 M901LC135 M901AC75 M901LR120SB

Diente adicional para sujetar los fardos.



▶ HORCA 901-4

REF.	€	g	A mm	B mm	C mm	L mm	M		
901-4	21,13	156157	12	900	39	225	485	32	M901LR120 M901LC135 M901AC75 M901LR120SB

Para recoger heno y estiércol.

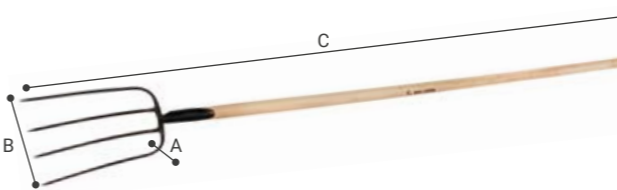

▶ HORCA MANGO LARGO CURVO 901-4MC SB

REF.	€	g	A mm	B mm	C mm	L mm		
9014MCSB	35,33	671261	2	1.600	190	201	1.647	32



▶ HORCA 901-5

REF.	€	g	A mm	B mm	C mm	L mm	M	
901-5	25,21	156201	12	1.010	250	470	34	M901LR120 M901LC135 M901AC75 M901LR120SB

Para recoger heno y estiércol.



HORCA 901-6

REF.	€	g	A mm	B mm	C mm	L mm	M
901-6	34,57	156218	12	1.350	240	310	450 35
M901LR120 M901LC135 M901AC75 M901LR120SB							

Para recoger heno y estiércol.



HORCA MANGO LARGO CURVO 901-6MC SB

REF.	€	g	A mm	B mm	C mm	L mm	M
9016MCSB	49,62	671322	2	1.600	220	310	1.650 35



HORCA MANGO ANILLA 902-3

REF.	€	g	A mm	B mm	C mm	L mm	M
902-4 MA	50,33	156164	2	1.925	180	230	1.180 32
M902AC75							



HORCA MANGO ANILLA 902-5

REF.	€	g	A mm	B mm	C mm	L mm	M
902-5 MA	58,62	156171	2	1.920	140	260	1.220 34
M902AC75							

Para recoger heno y estiércol.



HORCA MANGO ANILLA 902-6

REF.	€	g	A mm	B mm	C mm	L mm	M
902-6 MA	63,49	156188	2	2.500	130	350	1.235 35
M902AC75							

Para recoger heno y estiércol. Para trasladar gran cantidad de materiales ligeros.

## HORCAS DE PIEDRA Y GRAVA

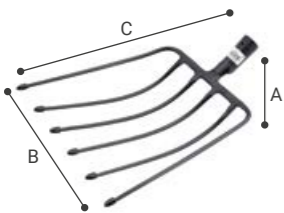

HORCA PIEDRA Y GRAVA 904

REF.	€	g	A mm	B mm	C mm	L mm	M
904-6	49,70	156256	12	1.550	70	280	445 36
M901LR120 M901LC135 M901AC75 M901LR120SB							

Para piedra y grava.



HORCA MANGO LARGO CURVO 904-6MC SB

REF.	€	g	A mm	B mm	C mm	L mm	M
9046MCSB	66,23	671353	2	1.600	70	280	1.650



HORCA PIEDRA Y GRAVA MANGO ANILLA 905-9

REF.	€	g	A mm	B mm	C mm	L mm	M
905-9 MA	90,96	156195	2	3.150	180	260	1.260 35
M901LR120 M901LC135 M901AC75 M901LR120SB							

Para piedra y grava.

## HORCAS DE JARDÍN

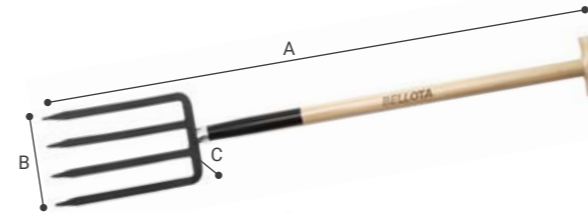

HORCA JARDÍN MANGO LARGO 911-4

REF.	€	g	A mm	B mm	C mm	L mm	M
911-4 MM	46,33	639131	2	1.850	1.165	188	50 27
M901LR120 M901LC135 M902AC75 M901LR120SB							

Para remover la tierra, desenterrar cultivos, airear y soltar el terreno muy compacto.



HORCA JARDÍN MANGO MULETA 911-4

REF.	€	g	A mm	B mm	C mm	L mm	M
911-4 MA	51,42	156270	2	1.980	55	190	1.220 27
M901LR120 M901LC135 M902AC75 M901LR120SB							

Para remover la tierra, desenterrar cultivos, airear y soltar el terreno muy compacto.



HORCA JARDÍN MANGO ANILLA 911-4

REF.	€	g	A mm	B mm	C mm	L mm	M
911-4 ML	46,77	375428	2	2.150	70	180	1.465 27
M901LR120 M901LC135 M902AC75 M901LR120SB							

Para remover la tierra, desenterrar cultivos, airear y soltar el terreno muy compacto.



HORCA JARDÍN 910-4

REF.	€	g	A mm	B mm	C mm	L mm	M
910-4	33,87	156263	12	1.210	40	195	405 27
M901LR120 M901LC135 M901AC75 M901LR120SB							

Para remover la tierra, desenterrar cultivos, airear y soltar el terreno muy compacto.

## GARABATOS

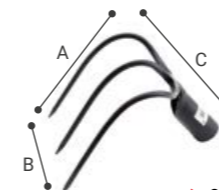

GARABATO 903-3

REF.	€	g	A mm	B mm	C mm	L mm	M
903-3	22,55	156225	12	520	240	180	175 21
M901LR120 M901LC135 M901AC75 M901LR120SB							

Para romper fardos.



GARABATO 903-4

REF.	€	g	A mm	B mm	C mm	L mm	M
903-4	22,94	156287	12	790	210	210	250 21
M901LR120 M901LC135 M901AC75 M901LR120SB							

Para romper fardos.



GARABATO 903-5

REF.	€	g	A mm	B mm	C mm	L mm	M
903-5	27,87	156232	12	900	210	240	250 21
M901LR120 M901LC135 M901AC75 M901LR120SB							

Para romper fardos.



GARABATO 903-6

REF.	€	g	A mm	B mm	C mm	L mm	M
903-6	34,24	156249	12	980	210	225	260 21
M901LR120 M901LC135 M901AC75 M901LR120SB							

Para romper fardos.



# RASTRILLOS Y ESCOBAS

## RASTRILLOS

- Fabricados con Acero Especial Bellota.
- Tres cabezas adaptadas a distintas intensidades de trabajo.
  - Alta intensidad: cabeza de acero con tratamiento 3+ para alargar la vida útil de la herramienta: no se rompe, no se deforma, no se desgasta.
  - Intensidad media: cabeza de acero con un diseño robusto: alta resistencia.
  - Uso doméstico: cabeza de acero de dimensiones más reducidas, más ligero para fácil manejo.
- Dos tipos de mangos:
  - Mangos de madera barnizados, ligeros y de tacto agradable. Certificados FSC®.
  - Mangos de fibra de vidrio huecos con dos foams para mejor agarre.
- Todos los rastrillos llevan pintura epoxi para evitar la oxidación.

### Usos:

- Para limpiar, igualar, preparar la tierra y cubrir los sembrados.

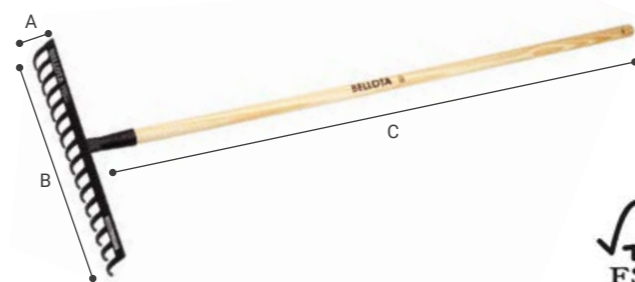
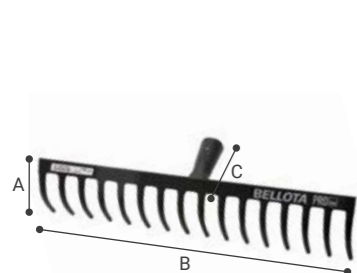

### ▶ RASTRILLO ALTA INTENSIDAD 950

REF.	€	8 41 4299	g	A mm	B mm	C mm	M
950-12	12,72	157819	12	520	100	320	100 M952 M952L M952LSB
950-14	13,54	157802	12	610	120	100	375 M952 M952L M952LSB
950-16	14,45	157796	12	650	100	430	100 M952 M952L M952LSB
950-18	15,99	157789	12	740	100	490	95 M952 M952L M952LSB

### ▶ RASTRILLO ALTA INTENSIDAD CON MANGO 950

REF.	€	8 41 4299	g	A mm	B mm	C mm	M
950-12 CML	22,37	667387	2	1.010	100	320	1.520 M952 M952L M952LSB
950-14 CML	23,27	667424	2	1.000	100	375	1.520 M952 M952L M952LSB
950-16 CML	24,02	667349	2	1.160	100	430	1.550 M952 M952L M952LSB
950-18 CML	25,58	667462	2	1.120	100	480	1.550 M952 M952L M952LSB



### ▶ RASTRILLO INTENSIDAD MEDIA 951

REF.	€	8 41 4299	g	A mm	B mm	C mm	M
951-10	8,63	157765	12	480	100	265	95 M952 M952L M952LSB
951-12	8,85	157758	12	540	100	320	95 M952 M952L M952LSB
951-14	9,28	157741	12	610	125	375	80 M952 M952L M952LSB
951-16	10,03	157734	12	680	100	430	199 M952 M952L M952LSB
951-18	10,53	157727	12	800	100	490	95 M952 M952L M952LSB
951-20	12,07	157710	12	820	100	545	95 M952 M952L M952LSB



### ▶ RASTRILLO INTENSIDAD MEDIA CON MANGO 951

REF.	€	8 41 4299	g	A mm	B mm	C mm	M
951-10 CML	18,30	667509	2	1.030	100	260	1.550 M952 M952L M952LSB M952SB
951-12 CML	18,71	667547	2	1.070	100	320	1.550 M952 M952L M952LSB M952SB
951-14 CML	18,59	667585	2	1.080	100	425	1.550 M952 M952L M952LSB M952SB
951-16 CML	19,35	667622	2	1.280	100	430	1.520 M952 M952L M952LSB M952SB
951-18 CML	20,58	667660	2	1.385	100	490	1.520 M952 M952L M952LSB M952SB
951-20 CML	21,73	667707	2	1.440	100	545	1.520 M952 M952L M952LSB M952SB



### ▶ RASTRILLO USO DOMÉSTICO 952

REF.	€	8 41 4299	g	A mm	B mm	C mm	M
952-12	6,98	157703	12	370	100	270	75 M952 M952L M952LSB
952-14	7,04	157697	12	420	100	320	75 M952 M952L M952LSB
952-16	7,72	157680	12	470	125	370	60 M952 M952L M952LSB



### ▶ RASTRILLO USO DOMÉSTICO CON MANGO 952

REF.	€	8 41 4299	g	A mm	B mm	C mm	M
952-12 CML	16,57	667745	2	910	75	320	1.540 M952 M952L M952LSB M952SB
952-14 CML	16,92	667783	2	860	100	320	1.540 M952 M952L M952LSB M952SB
952-16 CML	17,59	667820	2	1.055	100	370	1.520 M952 M952L M952LSB M952SB



### ▶ RASTRILLO USO DOMÉSTICO MANGO FIBRA DE VIDRIO 3102

REF.	€	8 41 4299	g	A mm	B mm	C mm	M
3102-14 MFVL	22,02	550689	2	1.300	100	375	1.560 M952 M952L M952LSB
3102-16 MFVL	22,99	550702	2	940	100	430	1.540 M952 M952L M952LSB



## ESCOBAS

- Fabricadas con Acero Especial Bellota.
- Tratamiento térmico en las varillas para asegurar la elasticidad y evitar deformaciones.
- Cubo resistente a la flexión.
- Pinturas y tratamientos para evitar la oxidación.
- Dos tipos de mangos:
  - Mangos de madera barnizados, ligeros y de tacto agradable. Certificados FSC®.
  - Mangos de aluminio ligeros y duraderos.

### Usos:

- Para limpiar el césped.
- Para recoger restos de césped cortado, hojas u otros residuos

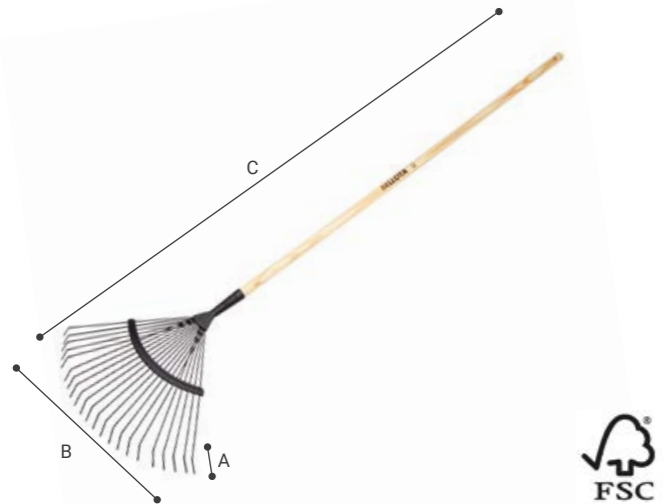

▶ ESCOBA DIENTE REDONDO 3040

REF.	€	8 41 4299	g	A mm	B mm	C mm	M
3040 CM	22,52	185539	6	870	60	470	M3020 M3020SB
3040	14,24	195095	6	590	27	440	M3020 M3020SB

Para limpieza de suelos de gravilla.



▶ ESCOBA DIENTE REDONDO MANGO ALUMINIO 3040

REF.	€	8 41 4299	g	A mm	B mm	C mm	M
3040CMA	25,91	652086	2	770	50	410	M3020 M3020SB

Para limpieza de suelos de gravilla.



▶ ESCOBA DIENTE PLANO 3041

REF.	€	8 41 4299	g	A mm	B mm	C mm	M
3041 CM	21,73	159417	6	900	25	400	M3020 M3020SB
3041	14,30	159639	12	440	30	385	M3020 M3020SB

Para limpieza de restos de césped cortado, hojas y residuos, sin dañar el césped.



▶ ESCOBA DIENTE PLANO AJUSTABLE MANGO ALUMINIO 3042

REF.	€	8 41 4299	g	A mm	B mm	C mm	M
3042 CMA	30,61	533743	6	830	40	390	M3020 M3020SB

Púa Plana. Anchura regulable 385 mm-480 mm.



▶ ESCOBA DIENTE PLANO MANGO ALUMINIO 3041

REF.	€	8 41 4299	g	A mm	B mm	C mm	M
3041 CMA	26,28	533729	6	770	50	410	M3020 M3020SB

Para limpieza de restos de césped cortado, hojas y residuos, sin dañar el césped.



▶ ESCOBA DIENTE PLANO AJUSTABLE 3042

REF.	€	8 41 4299	g	A mm	B mm	C mm	M
3042 CM	26,28	159424	6	960	25	400	M3020 M3020SB
3042	18,92	159646	12	520	40	385	M3020 M3020SB

Púa Plana. Anchura regulable 385 mm-480 mm.

## ESCOBAS DE PLÁSTICO



▶ ESCOBA PLÁSTICO 3034-24

REF.	€	8 41 4299	g	A mm	B mm	C mm	M
3034-24 CM	23,51	611410	6	850	55	630	M3020 M3020SB
3034-24	16,05	577471	6	420	40	620	M3020 M3020SB

Anchura de trabajo 620 mm.



▶ ESCOBA PLÁSTICO 3034-32

REF.	€	8 41 4299	g	A mm	B mm	C mm	M
3034-32 CM	27,76	611458	6	1.070	85	840	M3020 M3020SB
3034-32	18,48	611434	6	700	40	820	M3020 M3020SB

Anchura de trabajo 820 mm.



▶ ESCOBA DE PLÁSTICO 3035

REF.	€	8 41 4299	g	A mm	B mm	C mm	M
303513	4,00	048681	6	120	61	250	M3035
303523	8,00	048728	6	310	66	499	M3035
303535	11,90	048766	6	570	95	778	M3035



▶ MANGO ALUMINIO ESCOBAS PLÁSTICO M 3035

REF.	€	8 41 4299	g	A mm	B mm	C mm	M	
M 3035	13,5	52978	6	470	30	30	1614	303513 303523 303535

# GAMA FITO 0%

1

► **Nos adaptamos a las nuevas normativas:**

Apostamos por diseños que se ajustan a tus verdaderas necesidades y te facilitan tu día a día.

2

► **Pensadas para que te duren:**

- La azada de diamante y la azada quita hierbas están forjadas, por lo que son muy resistentes.
- Las azadas oscilantes, tienen una cuchilla templada y afilada, para quitar las malas hierbas de forma fácil y eficiente.

3

► **Comprometidos con el medio ambiente:**

- Con estas herramientas, además de cuidar de tu terreno y tus plantas, cuidarás del medioambiente ya que no necesitarás utilizar productos químicos para acabar con las malas hierbas.
- Nuestros mangos son de madera de haya y con certificado PEFC.

## TE AYUDAMOS A ELEGIR TU HERRAMIENTA:



AZADA DE DIAMANTE    AZADA QUITA HIERBAS    AZADA OSCILANTE DE 10    AZADA OSCILANTE DE 13

Para precisión y detalle	▲		▲	
Para zonas de difícil acceso	▲		▲	
Para quitar musgo y verdín	▲	▲		
Para quitar malas hierbas fibrosas		▲		
Para quitar malas hierbas ligeras/en superficie	▲		▲	▲
Para limpiar juntas en pavimentos	▲			
Para quitar malas hierbas en terrenos compactados (caminos, zonas de terrizo, jabre, albero, ríogolas...)	▲	▲		
Para quitar malas hierbas en terrenos mullidos (huertas, jardines trabajados...)			▲	▲

**MANTÉN TU TERRENO LIMPIO Y ELIMINA LAS MALAS HIERBAS SIN UTILIZAR PRODUCTOS QUÍMICOS.**

# HERRAMIENTAS FITO 0%

## HERRAMIENTAS FITO 0% MANGO LARGO

**Azada diamante:**

- Quita las malas hierbas con precisión y detalle.
- Acabado fácil para zonas de difícil acceso.
- Limpieza de musgo y verdín en zonas duras.
- La cabeza mide 20 cm.
- El mango con certificado PEFC mide 1.500 mm.

**Azada quita hierbas:**

- La cuchilla con muescas y afilada quita las hierbas más densas.
- Trabajo de empuje y tracción.
- La cabeza mide 17,5 cm
- El mango con certificado PEFC mide 1.500 mm.

**Azada oscilante:**

- La azada se inclina hacia adelante y atrás para quitar las malas hierbas en superficie.
- Cuchilla afilada.
- Dos medidas de cuchillas:
  - LHT308610W1500 AZADA OSCILANTE- 10 cm
  - LHT308612W1500 AZADA OSCILANTE- 12 cm
- El mango con certificado PEFC mide 1.500 mm.

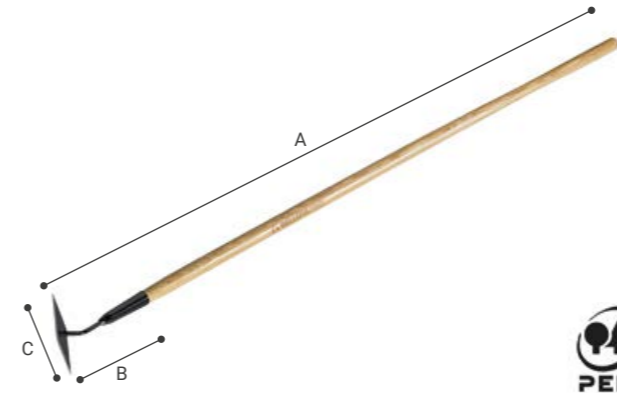

► AZADA DIAMANTE

REF.	€	8 41 4299	g	A mm	B mm	C mm	M
LHT3085W1500	19,78	705577	2	1.120	1.630	200 110	LHT3085 M3085



► AZADA OSCILANTE - 10CM

REF.	€	8 41 4299	g	A mm	B mm	C mm	M
LHT308610W1500	18,43	705638	2	1.240	1.690	100 140	LHT308610 M3085



► AZADA OSCILANTE - 13CM

REF.	€	8 41 4299	g	A mm	B mm	C mm	M
LHT308612W1500	19,78	705676	2	1.270	1.690	130 140	LHT308612 M3085



► AZADA QUITA HIERBAS - 18CM

REF.	€	8 41 4299	g	A mm	B mm	C mm	M
LHT3087W1500	25,78	705737	2	1.310	1.660	180 70	LHT3087 M3087

# HERRAMIENTAS PARA EL HUERTO

## HERRAMIENTAS DE MANGO LARGO

- Herramientas de acero muy ligeras.
- Pinturas y recubrimientos especiales para evitar la oxidación.
- Mangos de madera barnizados, ligeros y de tacto agradable. Longitud 1.500 mm. Certificados PEFC.
- Mangos de diámetro variable para adaptarse a diferentes tamaños de mano.

**Usos:**

- Para trabajos de jardinería y cultivo doméstico.
- Para remover, airear, desterronar y plantar.

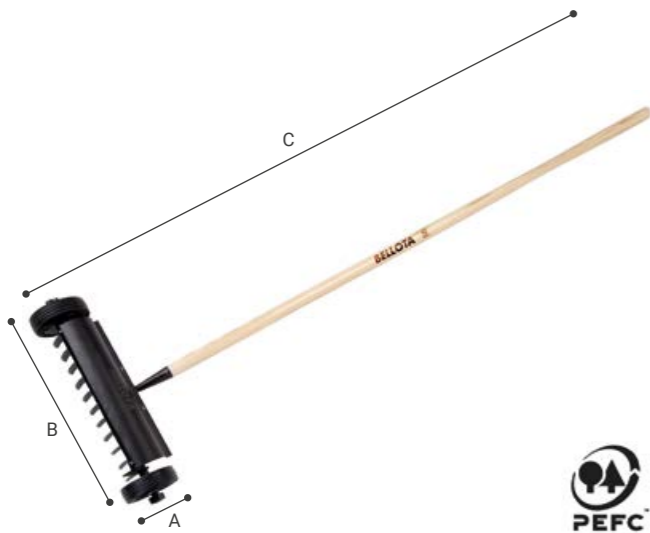

► ESCARIFICADOR CON RUEDAS 3080

REF.	€	8 41 4299	g	A mm	B mm	C mm
3080 CM	40,69	612301	1	2.400	150	520
3080	33,14	612271	1	1.650	140	180

Para acondicionar el césped en primavera y otoño. Primavera: limpieza y eliminación de musgo y otros residuos. Otoño: preparación del césped para la entrada en la fase de recuperación vegetativa.



► AZADA BINADORA 3081

REF.	€	8 41 4299	g	A mm	B mm	C mm
3081 CM	18,73	609912	6	1.240	150	250
3081	9,83	609899	6	360	100	155

Para escardar, romper la costra superficial y quitar malas hierbas cortando raíces.



► AZADA PICO 3082

REF.	€	8 41 4299	g	A mm	B mm	C mm
3082 CM	18,80	609950	6	1.060	120	1.590
3082	8,79	609936	6	280	100	180

Multiuso: cavar y cerrar surcos, escardar y preparar la siembra.



► AZADA CORTA RAÍCES 3083

REF.	€	8 41 4299	g	A mm	B mm	C mm
3083 CM	18,80	609998	6	1.070	80	150
3083	8,79	609974	6	200	65	170

Para cortar raíces a poca profundidad en suelos de tierra suelta. Trabaja hacia los dos sentidos: empujar y tirar.



► CULTIVADOR 3 PÚAS 3084

REF.	€	8 41 4299	g	A mm	B mm	C mm
3084 CM	17,00	610031	6	1.010	80	120
3084	7,20	610017	6	210	80	125

Para escarbar y airear el suelo. Quitar malas hierbas y raíces.

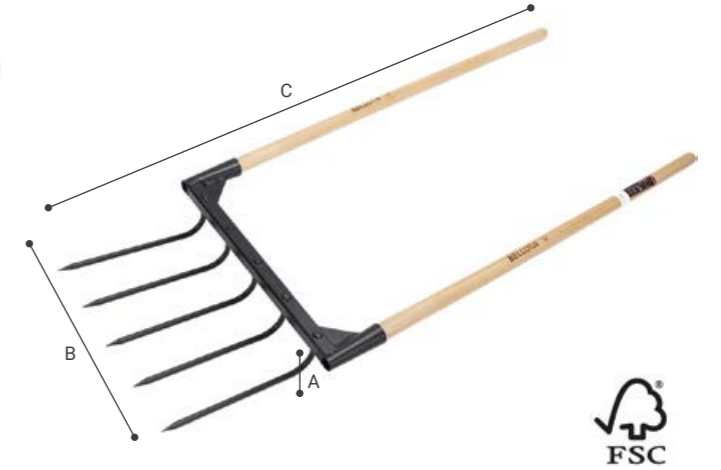

► HORCA ECOLÓGICA 914-5 ECO

REF.	€	8 41 4299	g	A mm	B mm	C mm	C mm
914-5 ECO	102,99	633184	1	4.150	110	530	1.420
						42	

Para descompactar y airear la tierra sin darle la vuelta, con el objetivo de preservar las diferentes capas microbiológicas. Permite respetar los beneficios de los micro-organismos que convierten la materia orgánica en abono natural y fertilizan el suelo. Uso en tierras trabajadas.

## HERRAMIENTAS DE MANGO CORTO FIBRA DE VIDRIO

- Fabricadas con fibra de vidrio: ligeras y resistentes.
- Diseños optimizados para un trabajo cómodo.
- Fáciles de limpiar.

### Usos:

- Para trabajos en terrazas, macizos, rocallas y balcón

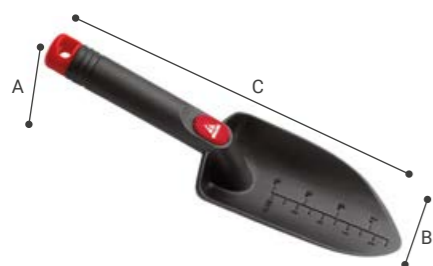

▶ TRASPLANTADOR 2985

REF.	€	8 41 4299	g	A mm	B mm	C mm
2985	4,51	168006	6	120	40	85

Para trasplantar. Ancho de trabajo: 85 mm.



▶ TRASPLANTADOR ESTRECHO 2986

REF.	€	8 41 4299	g	A mm	B mm	C mm
2986	4,51	169614	6	100	40	60

Para trasplantar. Ancho de trabajo: 60 mm.



▶ CULTIVADOR 2987

REF.	€	8 41 4299	g	A mm	B mm	C mm
2987	4,51	169669	6	99	45	85

Para remover y airear la tierra.



▶ AZUELA - HORQUILLA 2990

REF.	€	8 41 4299	g	A mm	B mm	C mm
2990	6,55	169812	6	160	75	210

Para desterronar y airear la tierra.



▶ KIT DE HERRAMIENTAS 2994

REF.	€	8 41 4299	g	A mm	B mm	C mm
2994	15,56	577341	4	630	70	255

Ideal para realizar las tareas básicas. Ideal para regalar.



▶ CUCHILLO HORI HORI HMC3000S

REF.	€	8 41 4299	g	A mm	B mm	C mm
HMC3000S	14,00	026092	1	270	326	70

## HERRAMIENTAS DE MANGO CORTO ALUMINIO

- Fabricadas en aluminio de una sola pieza: ligeras, sólidas y resistentes.
- Diseño estudiado para un mayor rendimiento y fácil manejo.
- Mangos bimateriales con acabado SOFT TOUCH para mayor comodidad durante el trabajo.

### Usos:

- Para trabajos en terrazas, macizos, rocallas y balcón.

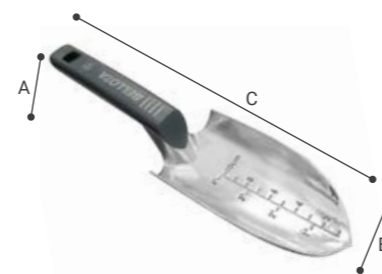

▶ TRASPLANTADOR 3001

REF.	€	8 41 4299	g	A mm	B mm	C mm
3001	8,67	159493	6	200	30	80

Para trasplantar. Ancho de trabajo: 80 mm.



▶ TRASPLANTADOR ESTRECHO 3000

REF.	€	8 41 4299	g	A mm	B mm	C mm
3000	8,82	170306	6	190	50	60

Para trasplantar. Ancho de trabajo: 60 mm.



▶ CULTIVADOR 2998

REF.	€	8 41 4299	g	A mm	B mm	C mm
2998	9,00	170122	6	261	40	80

Para remover y airear la tierra.



▶ AZUELA - HORQUILLA 3005

REF.	€	8 41 4299	g	A mm	B mm	C mm
3005	9,30	159530	6	370	50	200

Para desterronar y airear la tierra.



▶ RASTRILLO 3006

REF.	€	8 41 4299	g	A mm	B mm	C mm
3006	8,92	159547	6	280	60	110

Para limpiar, alisar, preparar la tierra y cubrir las semillas.



▶ PINCHO PLANTADOR 3003

REF.	€	8 41 4299	g	A mm	B mm	C mm
3003	8,57	159516	6	180	32	120

Para plantar bulbos y plantones.



▶ PLANTABULBOS MÓVIL 3012

REF.	€	8 41 4299	g	A mm	B mm	C mm
3012	7,99	169966	6	250	75	120

Para plantar bulbos y plantas de hasta 6 mm de diámetro.



▶ KIT DE HERRAMIENTAS 3076

REF.	€	8 41 4299	g	A mm	B mm	C mm
3076	30,83	561937	4	1.200	65	260

Ideal para realizar las tareas básicas. Ideal para regalar.

# GAMA ELÉCTRICA

1

## ▶ Ergonomía:

Tienen un diseño que se adapta muy bien a tu mano y a los movimientos habituales entre ramas. No tienes que forzar la postura, tus manos, tus brazos y tu espalda te lo agradecerán.

2

## ▶ Libertad de movimiento:

Sin cables ni mochila, te moverás con total libertad entre las ramas.

3

## ▶ Ligereza:

Son máquinas ligeras y compactas, para que realices tu tarea de forma cómoda y sin cansarte.

## CON LA NUEVA GAMA ELÉCTRICA:

OPTIMIZARÁS  
EL TIEMPO  
DE TRABAJO

CONSEGUIRÁS  
MEJORES  
RESULTADOS

REALIZARÁS  
MENOS  
ESFUERZO

NEW

### PANTALLA O-LED CON INDICADORES

- % BATERÍA RESTANTE
- HISTORIAL CORTES TOTALES
- Nº DE CORTES ACTUAL (DESDE ON)
- CÓDIGO DE SOLUCIÓN DE ERRORES

**POWER CUT**

### EMPUÑADURA BIMATERIAL

CON MAYOR SUPERFICIE DE ELASTÓMERO QUE EVITA RESALTES MOLESTOS PARA LA MANO.

### DOBLE APERTURA DE CORTE:

EPR233P  
EPR233P2B  
EPR233P3B

Ø 20 MM A 33 MM

OPCIÓN DE CORTE  
PROGRESIVO /  
POR IMPULSO  
CON CAMBIO  
RÁPIDO: 1 SEGUNDO.

HOJA  
DE CORTE  
FORJADA  
Y ENTERIZA  
PARA AUMENTAR  
LA DURABILIDAD.

SISTEMA DE  
SEGURIDAD  
ANTI-CORTE.

BULÓN DE ENGRASE MEJORADO  
QUE MANTIENE TODO  
EL MECANISMO ENGRASADO.

BOTÓN ON/OFF +  
ACTIVACIÓN  
DIFERENTES  
FUNCIONALIDADES.

EPR233P  
EPR233P2B  
EPR233P3B

PESO C/BATERÍA: 950 GR.  
PESO S/BATERÍA: 710 GR.

EPR238P  
EPR238P2B  
EPR238P3B

PESO C/BATERÍA: 1.235 GR.  
PESO S/BATERÍA: 890 GR

Ref. EPR233P

**NUEVO SISTEMA  
POWER  
CUT**

Mejora las prestaciones y el rendimiento.



MAYOR  
RAPIDEZ



MAYOR  
POTENCIA  
DE CORTE



MAYOR  
SENSIBILIDAD



MISMO  
CONSUMO

## ▶ COMPARATIVA TIJERAS



EPR123P



EPR233P / EPR233P2B /  
EPR233P3B



EPR238P / EPR238P2B /  
EPR238P3B

Capacidad de corte máxima	Ø 23 mm	Ø 33 mm	Ø 38 mm
Capacidad de corte	Ø 16 mm / 23 mm	Ø 20 mm / 33 mm	Ø 22 mm / 38 mm
Tipo de corte	Corte progresivo / Corte por impulso	Corte progresivo / por impluso con cambio rápido 1s	Corte progresivo / por impluso con cambio rápido 1s
Prevención de corte	Prevención de corte por arco eléctrico (desactivable)	Prevención de corte por arco eléctrico (desactivable)	Prevención de corte por arco eléctrico (desactivable)
Peso de la tijera (con batería)	880 gr	950 gr	1.235 gr
Peso de la tijera (sin batería)	690 gr	710 gr	890 gr
Peso de la batería	190 gr	238 gr	350 gr
Máxima potencia	400 W	500 W	800 W
Motor	Sin escobillas	Sin escobillas	Sin escobillas
Temperatura de trabajo	-10°C hasta +60°C	-10°C hasta +60°C	-10°C hasta +60°C
Voltaje máximo	10,8 V	16,8 V	25,2 V
Tipo de batería	Litio-ion	Litio-ion	Litio-ion
Voltaje nominal	10,8 V	14,4 V	21,6 V
Amperaje o capacidad	2.5 Ah	2.5 Ah	2.5 Ah
Autonomía aprox. por batería	2,5-4,5 h / 4.000 cortes (según ø y dureza de rama)	2-2,5 h / 4.000 cortes (según ø y dureza de rama)	3-5 h / 4.000 cortes (según ø y dureza de rama)
Tiempo de carga por batería	1-2,5 h	2-2,5 h	2-2,5 h
Garantía	Tijera: 1 año Batería: 1 año	Tijera: 1 año Batería: 1 año	Tijera: 1 año Batería: 1 año

## ▶ MOTOSIERRA A BATERÍA

ECS1100P



Peso de la motosierra (con batería)	1.800 gr
Peso de la motosierra (sin batería)	1.300 gr
Peso de la batería	490 gr
Tipo de batería	Litio-ion
Voltaje nominal	24 V
Amperaje o capacidad	4.2 Ah
Autonomía aprox. por batería	Dependiendo al uso que se le someta
Tiempo de carga por batería	2-2,5 h
Garantía	Motosierra: 1 año. Batería: 1 año
Potencia nominal	470 W
Motor	Sin escobillas
Temperatura de trabajo	-10°C hasta +60°C
Voltaje máximo	25.2 V
Capacidad de corte máxima	Ø 110 mm
Velocidad de la cadena	Ø 11 m/s
Guía	4,5" (110 mm). Hendidura 0,043" 1,1 mm
Cadena de motosierra	38 eslabones de 1/4" (6,35)
Piñón de cadena	7
Lubricación de cadena	Bomba de aceite autorregulable
Tensión de carga	CA 110V-220V
Capacidad del tanque de aceite	100ml
Monitor	5 dígitos para la referencia de artículo Porcentaje de batería restante Tiempo de funcionamiento
Sistema de accionamiento	Es necesario accionar 3 pulsadores para poner en marcha la cadena

# PODA EN ALTURA

## ► PÉRTIGA MOTOSIERRA

### ECSP1210P



Peso con batería	3.750 gr.
Peso sin batería	3.000 gr.
Peso batería	750 gr.
Medidas con batería	1.767-2.570 x 200 x 56 mm
Medidas sin batería	1.767-2.570 x 88 x 56 mm
Tipo de batería	Litio-ion
Voltaje máximo	25.2 V
Voltaje nominal	21.6 V
Amperaje o capacidad	5 Ah
Potencia	108 Wh
Autonomía aproximada	En función de diámetro de corte / tipo de uso
Tiempo de carga por batería	1-2,5 h
Garantía	Pértiga: 1 año Batería: 1 año
Voltaje máximo	25.2 V
Máxima potencia	550 W
Motor	Sin escobillas
Temperatura de funcionamiento	-10°C hasta +60°C
Capacidad de corte máxima	Ø 210 mm
Velocidad cadena	12 m/s
Otras funciones	Lubricación automática y medida regulable
Monitor	LCD que muestra el porcentaje de batería
Capacidad de tanque	40 ml.
Prevención corte	Botón de seguridad

## ► PÉRTIGA TIJERA

### EPRP140P



Uso recomendado	Poda en altura
Peso con batería	Según batería que se utilice
Peso sin batería	2.200 gr.
Peso batería	Según batería que se utilice
Medidas con batería	1.600 x 90 x 80 mm
Medidas sin batería	1.600 x 90 x 80 mm
Tipo de batería	Litio-ion
Voltaje máximo	25.2 V
Voltaje nominal	21.6 V
Amperaje o capacidad	2,5 Ah / 4,2 Ah / 5 Ah
Potencia	720 W
Autonomía aproximada	En función de diámetro de corte / tipo de uso
Garantía	Tijera: 1 año Batería: 1 año
Voltaje máximo	25.2 V
Máxima potencia	720 W
Motor	Sin escobillas
Temperatura de funcionamiento	-10°C hasta +60°C
Capacidad de corte máxima	Ø 40 mm
Velocidad corte	1,5 s
Otras funciones	Lubricación automática y medida regulable
Monitor	-

## ► ATADORA ELÉCTRICA

### ETY125P



Peso de la atadora (con batería)	1.215 gr.
Peso de la atadora (sin batería)	897 gr.
Peso de la batería	228 gr.
Tipo de batería	Litio-ion
Voltaje nominal	14.4 V
Amperaje o capacidad	2.5 Ah
Autonomía aprox. por batería	3-4 h / 5.500 atados
Tiempo de carga por batería	2-2,5 h
Garantía	Atadora: 1 año Batería: 1 año
Máxima potencia	500 W
Motor	Sin escobillas
Temperatura de trabajo	-10°C hasta + 60°C
Voltaje máximo	16.8 V
Diámetro de trabajo	Ø 25 mm
Atado	4 posiciones para selección de número de giros del hilo: - Posición 1: 3 vueltas de hilo - Posición 2: 4 vueltas de hilo - Posición 3: 5 vueltas de hilo - Posición 4: 6 vueltas de hilo
Tiempo de atado	Rápido: 0,3 s.

PARA  
SABER  
MÁS...



## ► BATERÍAS

### ECBAEPR123P

Voltaje máximo	12,6 V
Voltaje nominal	10,8 V
Amperaje	2,5 Ah
Potencia	27 Wh
Peso	190 gr.

### ECBAEPR132P

Voltaje máximo	16,8 V
Voltaje nominal	14,4 V
Amperaje	2,5 Ah
Potencia	36 Wh
Peso	238 gr.

### ECBAEPR137P

Voltaje máximo	25,2 V
Voltaje nominal	21,6 V
Amperaje	2,5 Ah
Potencia	54 Wh
Peso	350 gr.

### ECBAECS1100P

Voltaje máximo	25,2 V
Voltaje nominal	21,6 V
Amperaje	4,2 Ah
Potencia	90,72 Wh
Peso	490 gr.

### ECBAETY125P

Voltaje máximo	16,8 V
Voltaje nominal	14,4 V
Amperaje	2,5 Ah
Potencia	36 Wh
Peso	228 gr.

## ► COMPATIBILIDAD BATERÍAS

<b>EPR123P</b> 14,4 V	<b>EPR233P</b> 14,4 V	<b>ETY125P</b> 14,4 V	<b>EPR238P</b> 21,6V	<b>ECS1100P</b> 21,6V	<b>EPRP140P</b> 21,6 V	<b>ECSP1210P</b> 21,6 V
<b>ECBAEPR123P</b> 10,8V 2,5AH	<b>ECBAEPR132P</b> 14,4V 2,5AH	<b>ECBAETY125P</b> 10,8V 2,5AH	<b>ECBAEPR137P</b> 21,6V 2,5AH	<b>ECBAECS1100P</b> 21,6V 2,5AH		<b>ECBA5AHP</b> 21,6 5AH

# CORTE Y PODA

- Trabaja de forma cómoda y accede de forma sencilla a cualquier punto.
- La motosierra será tu aliada perfecta, ya sea para utilizarla sola, para podar y limpiar tus árboles y cultivos leñosos, o como complemento de la tijera eléctrica.
- Las tijeras eléctricas sin cable, con su diseño de cabezal adaptable, permiten realizar cortes más veloces y precisos, aumentando considerablemente la productividad, y favoreciendo la correcta cicatrización de la rama.
- La pértiga eléctrica extensible es el complemento perfecto para la tijera ya que podrás alcanzar las ramas más altas.
- La atadora dispone de 4 modos de atado, el 1 para ramas más gruesas (3 giros) y el 4 para ramas más finas (6 giros).
- En Bellota, cuidamos el medioambiente, por ello, el hilo que acompaña a nuestra atadora es de papel biodegradable.

## Usos:

- Para poda universal: viña, frutal y olivo.

## TIJERAS ELÉCTRICAS



### TIJERA ELÉCTRICA EPR123P

REF.	€	8 41 4299	g	L mm	Ø Corte
EPR123P	230,00	015669	1 2	880 290	16-23

**Contiene:** Tijera eléctrica EPR123P, 2 baterías de Litio-ion, cargador 2 vías, herramientas de mantenimiento y manual de instrucciones.



### TIJERA ELÉCTRICA EPR233P / EPR233P2B / EPR233P3B

REF.	€	8 41 4299	g	L mm	Ø Corte
EPR233P	230,00	032949	1 -	710 250	20-33
EPR233P2B	346,70	054118	1 2	950 295	20-33
EPR233P3B	404,49	032925	1 3	950 295	20-33

**Contenido del maletín EPR233P3B:** Tijera eléctrica EPR133P3B 3 baterías de Litio-ion (autonomía para una jornada completa), cargador 3 vías, herramientas de mantenimiento, aplicador de aceite para lubricación, manual de instrucciones. **Contenido del maletín EPR233P2B:** Tijera eléctrica EPR233P2B, 2 baterías Litio-ion, cargador 3 vías, herramientas de mantenimiento, aplicador de aceite para lubricación, manual de instrucciones. **EPR233P:** Contiene la tijera eléctrica EPR233P sin baterías.



### TIJERA ELÉCTRICA EPR238P / EPR238P2B / EPR238P3B

REF.	€	8 41 4299	g	L mm	Ø Corte
EPR238P	300,00	054101	1 -	890 295	22-38
EPR238P2B	429,29	054071	1 2	1.235 290	22-38
EPR238P3B	504,29	032956	1 3	1.235 295	22-38

**Contenido del maletín EPR238P3B:** Tijera eléctrica EPR238P3B, 3 baterías de Litio-ion (autonomía para una jornada completa), cargador 3 vías, herramientas de mantenimiento, aplicador de aceite para lubricación, manual de instrucciones. **Contenido del maletín EPR238P2B:** Tijera eléctrica EPR238P2B, 2 baterías Litio-ion, cargador 3 vías, herramientas de mantenimiento, aplicador de aceite para lubricación, manual de instrucciones. **EPR238P:** Contiene la tijera eléctrica EPR238P sin baterías.

## MOTOSIERRA ELÉCTRICA



### MOTOSIERRA ELÉCTRICA ECS1100P / ECS1100PS

REF.	€	8 41 4299	g	A mm	B mm	C mm
ECS1100P	556,82	699531	1 3	1.800 450	75	160
ECS1100PS	300,00	713305	1 -	1.300 400	65	160

**Contenido del maletín ECS1100P:** Motosierra eléctrica ECS1100P, 3 baterías de Litio-ion (autonomía para una jornada completa), cargador 3 vías, herramientas de mantenimiento, manual de instrucciones, maletín rígido para el transporte. **ECS1100PS:** Contiene motosierra eléctrica ECS1100PS sin baterías.

## ATADORA ELÉCTRICA



### ATADORA ELÉCTRICA ETY125P

REF.	€	8 41 4299	g	L mm
ETY125P	473,98	690774	1 3	1.215 300

**Contenido del maletín:** Atadora eléctrica ETY125P, 2 baterías Litio-ion, cargador 2 vías, 3 rollos de hilo de atar, herramienta para el mantenimiento, manual de instrucciones.

## PODA EN ALTURA



### TIJERA PÉRTIGA EPR140P

REF.	€	8 41 4299	g	L mm
EPR140P	420,24	708707	1	2.200 1.600

No incluye batería.



### PÉRTIGA MOTOSIERRA ECSP1210P

REF.	€	8 41 4299	g	L mm
ECSP1210P	462,06	708691	1	3.750 1.767 - 2.570

Se vende con una batería de 5Ah.



### PÉRTIGA EXTENSIBLE PARA TIJERA ELÉCTRICA EPP1EXTP

REF.	€	8 41 4299	g	L mm
EPP1EXTP	168,10	690767	1	1.380 1.570 - 2.200

\* Compatible con las tijeras eléctricas Ref. EPR132P/EPR1322BP/EPR137P.



# COMPLEMENTOS GAMA ELÉCTRICA



► CABLE EXTENSOR DE BATERÍA ECEC115P

REF.	€	8 41 4299	g	A mm	B mm	C mm	
ECEC115P	52,89	698848	1	200	1.125	65	70



► FUNDA PARA TIJERA ECSEPR1P

REF.	€	8 41 4299	g	A mm	B mm	C mm	
ECSEPR1P	17,64	699494	1	200	440	150	50



► FUNDA PARA MOTOSIERRA ECECS1P

REF.	€	8 41 4299	g	A mm	B mm	C mm	
ECECS1P	20,86	699548	1	220	500	170	80



► FUNDA PARA BATERÍAS ECSEB1P

REF.	€	8 41 4299	g	A mm	B mm	C mm	
ECSEB1P	9,41	660661	1	80	120	110	80



► REPUESTOS PARA MOTOSIERRA ELÉCTRICA ECST100P / ECST100PS

REF.	€	8 41 4299	g	A mm	B mm	C mm	
ECCHCS1100P	54,69	703757	1	270	260	170	90



► CINTURÓN CON TIRANTES PARA FUNDAS ECBEPR1P

REF.	€	8 41 4299	g	A mm	B mm	C mm	
ECBEPR1P	33,51	704570	1	200	70	500	40



► GRASA DE LITIO CON APLICADOR 400ML GRS6664

REF.	€	8 41 4299	g	A mm	B mm	C mm	
GRS6664	13,04	705942	12	370	70	66	190



► GUANTE PARA MOTOSIERRA

REF.	€	8 41 4299	g	A mm	B mm	C mm	
ECGL1209P	31,11	017014	1	140	125	250	40
ECGL1210P	31,11	017472	1	150	130	260	40
ECGL1211P	31,11	017519	1	160	135	280	40

# REPUESTOS GAMA ELÉCTRICA

## PARA TIJERA ELÉCTRICA EPR123P



### ► REPUESTOS PARA TIJERA ELÉCTRICA EPR123P

REF.	€	8 41 4299	g	A mm	B mm	C mm	T	
SP23EPR123P	22,56	717143	1	40	80	40	5	EPR123P
SP24EPR123P	24,21	717150	1	30	72	25	4	EPR123P
SP27EPR123P	5,24	717167	1	30	24	24	34	EPR123P
ECBAEPR123P	42,41	717259	1	190	85	55	55	EPR123P
ECCHEPR123P	39,58	717242	1	280	130	100	50	ECBAEPR123P

## PARA TIJERA ELÉCTRICA EPR233P / EPR233P2B / EPR233P3B



### ► REPUESTOS PARA TIJERA ELÉCTRICA EPR233P / EPR233P2B / EPR233P3B

REF.	€	8 41 4299	g	A mm	B mm	C mm	T	
H233P	45,33	055191	1	84	100	55	15	EPR233/EPR233P2B/EPR233P3B
CH233P	40,00	691092	1	42	78	40	5	EPR233/EPR233P2B/EPR233P3B
SP05EPR233P	4,90	055214	1	35	20	5	5	EPR233/EPR233P2B/EPR233P3B
ECBAEPR132P	64,64	690781	1	340	75	55	55	EPR233/EPR233P2B/EPR233P3B
ECCHEPR132P	52,89	690804	1	250	130	50	50	ECBAEPR132P

## PARA TIJERA ELÉCTRICA EPR238P / EPR238P2B / EPR238P3B



### ► REPUESTOS PARA TIJERA ELÉCTRICA EPR238P / EPR238P2B / EPR238P3B

REF.	€	8 41 4299	g	A mm	B mm	C mm	T	
H238P	50,66	056235	1	97	115	45	15	EPR238P/EPR238P2B/EPR238P3B
CH238P	41,33	056426	1	62	97	50	5	EPR238P/EPR238P2B/EPR238P3B
SP05EPR238P	4,90	056471	1	35	20	5	5	EPR238P/EPR238P2B/EPR238P3B
ECBAEPR137P	76,40	690781	1	340	75	55	55	EPR238P/EPR238P2B/EPR238P3B
ECCHEPR137P	64,64	690804	1	250	130	50	50	ECBAECS1100P/ECBAEPR137P/ECBA5AHP

## PARA MOTOSIERRA ELÉCTRICA ECS1100P / ECS1100PS



SP57ECS1100P

SP58ECS1100P

SP73ECS1100P

ECBAECS1100P

ECCHECS1100P

## ▶ REPUESTOS PARA MOTOSIERRA ELÉCTRICA ECS1100P / ECS1100PS

REF.		€	8 41 4299	g	A mm	B mm	C mm		
SP57ECS1100P	Espada guía	14,85	703665	1	90	190	35	4	ECS1100P / ECS1100PS
SP58ECS1100P	Cadena de 1/4" de 38 eslabones	20,28	703672	1	50	240	30	4	ECS1100P / ECS1100PS
SP73ECS1100P	Tapón del depósito de aceite	2,28	703825	1	10	40	40	80	ECS1100P / ECS1100PS
ECBAECS1100P	Batería Ion-Litio 21,6V de 4,2Ah	92,67	703740	1	490	80	60	75	ECS1100P / EPR137PR / EPRP140P
ECCHECS1100P	Cargador de triple vía de 21,6V	54,69	703757	1	270	260	170	90	ECBAECS1100P / ECBAEPR137P / ECBA5AHP

## PARA PÉRTIGA MOTOSIERRA ECSP1210P



SP79ECSP1210P

SP80ECSP1210P

SP97ECSP1210P

SP101ECSP1210P

ECBA5AHP

## ▶ REPUESTOS PARA PÉRTIGA MOTOSIERRA ECSP1210P

REF.		€	8 41 4299	g	A mm	B mm	C mm		
SP79ECSP1210P	Plato guía de la cadena	23,07	712964	1	150	260	35	4	ECSP1210P
SP80ECSP1210P	Cadena de 48 eslabones	28,54	712971	1	70	100	100	10	ECSP1210P
SP97ECSP1210P	Ensamblaje de la tapa del bote de aceite	8,37	713152	1	10	60	25	25	ECSP1210P
SP101ECSP1210P	Ensamblaje cubierta de la cadena	4,00	713176	1	40	100	65	20	ECSP1210P
ECBA5AHP	Batería de 21,6V de 5Ah	103,71	708684	1	750	90	90	90	ECSP1210P / EPRP140P

## PARA PÉRTIGA TIJERA EPRP140P



SP18EPRP140P

SP19EPRP140P

SP23EPRP140P

SP61EPRP140P

## ▶ REPUESTOS PARA PÉRTIGA TIJERA EPRP140P

REF.		€	8 41 4299	g	A mm	B mm	C mm		
SP18EPRP140P	Contrahoja tijera pértiga	51,99	711431	1	190	180	80	5	EPRP140P
SP19EPRP140P	Hoja tijera pértiga	60,16	711462	1	120	115	80	5	EPRP140P
SP23EPRP140P	Eje estriado de la hoja	5,26	711554	1	30	22	22	22	EPRP140P
SP61EPRP140P	Ensamblaje protección de batería	11,31	712063	1	60	75	75	75	EPRP140P

## PARA ATADORA ELÉCTRICA ETY125P



ECBAETY125P

ECCHETY125P

ECTYWPA100P

## ▶ REPUESTOS ATADORA ETY125P

REF.		€	8 41 4299	g	A mm	B mm	C mm		
ECBAETY125P	Batería Ion-Litio 14,4V de 2,5Ah	51,89	690828	1	228	100	80	70	ETY125P
ECCHETY125P	Cargador de doble vía de 14,4V	63,42	691092	1	180	85	50	50	ECBAETY125P
ECTYWPA100P	Bobina de papel	3,91	690835	1	160	80	80	40	ETY125P

\*\*Para más información acerca de los repuestos consulta con tu comercial de zona o en el SAT BELLOTA.

## TIJERAS MANUALES

## RECOLECTORAS-PROLINE

- Hojas de acero INOXIDABLE y con recubrimiento antiadherente: protección contra la oxidación y las plagas.
- Hojas tratadas para evitar roturas y alargar la vida de la herramienta.
- Mangos bimateriales ergonómicos con acabado SOFT TOUCH para mayor comodidad durante el trabajo.
- Sistema de bulón ajustable.
- Muelle de recambio disponible.

## Usos:

- Para recolección de uva, fruta y flores.

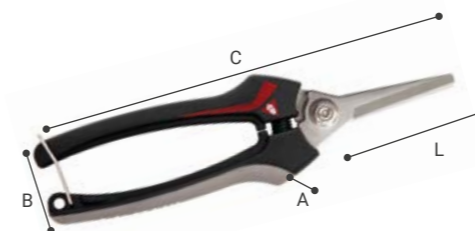

## ▶ RECOLECTORA 3621

REF.	€	8 41 4299	g	A mm	B mm	C mm	L mm	Ø Corte
3621 INOX-CE MB	9,78	608588	24	90	15	50	180	62 5
3621-C	11,60	623260	6	100	15	50	180	62 5

Hoja larga con punta redondeada para no dañar los frutos. Para recolección de uva, fruta y verdura.



## ▶ RECOLECTORA 3622

REF.	€	8 41 4299	g	A mm	B mm	C mm	L mm	Ø Corte
3622 INOX-CE MB	9,78	588255	24	100	15	50	185	62 10
3622-C	11,60	627398	6	100	5	62	185	62 10

Hoja de corte deslizante, estrecha y alargada. Para acceder de manera cómoda a los tallos para corte y clareo.



## ▶ RECOLECTORA 3623

REF.	€	8 41 4299	g	A mm	B mm	C mm	L mm	Ø Corte
3623 INOX-CE MB	9,78	588231	24	90	15	50	190	60 5
3623-C	11,60	635621	6	90	15	50	185	60 5

Hoja estrecha y alargada. Para recolección de uva y fruta. Para poda delicada en zonas de difícil acceso.



## ▶ RECOLECTORA 3624

REF.	€	8 41 4299	g	A mm	B mm	C mm	L mm	Ø Corte
3624 INOX-CE MB	9,78	588279	24	90	14	50	190	62 5
3624-C	11,60	634921	6	90	15	50	185	62 5

Hoja alargada y recta. Para recolección de uva.



## ▶ RECOLECTORA 3625

REF.	€	8 41 4299	g	A mm	B mm	C mm	L mm	Ø Corte
3625 INOX-CE MB	10,10	588293	24	90	15	50	160	34 5
3625-C	11,60	635645	6	80	19	50	160	34 5

Hoja corta y curva. Para recolección de frutas y flores. Corte delicado.



## ▶ RECOLECTORA 3628

REF.	€	8 41 4299	g	A mm	B mm	C mm	L mm	Ø Corte
3628 INOX-CE MB	9,78	588316	24	90	17	48	172	45 10
3628-C	11,60	626940	6	93	15	50	170	45 10

Hoja deslizante pequeña. Para recolección de uva, fruta y el corte y poda de pequeños tallos.



## ▶ RECOLECTORA 3629

REF.	€	8 41 4299	g	A mm	B mm	C mm	L mm	Ø Corte
3629INOXGR25MB	9,78	588330	25	100	15	50	200	79 5

Hoja larga y recta. Para recolección de uva, fruta, y tallos de ajo.

## TIJERAS DE UNA MANO-PROLINE

- Corte fácil y limpio: diseñadas para conseguir una perfecta penetración y deslizamiento de la hoja de corte en la rama.
- Hojas de Acero Especial Bellota de alta resistencia al desgaste para alargar la vida de la herramienta.
- Sistema de articulación AJUSTE FÁCIL PATENTADO para garantizar un ajuste de la tijera preciso, sencillo y estable en el tiempo.
- Diseño de mangos ergonómicos para una perfecta adaptación a la mano y mayor transmisión de la fuerza de corte.
- Todas las piezas de recambio están disponibles.

### Usos:

- Para poda universal: viña, frutal y olivo.

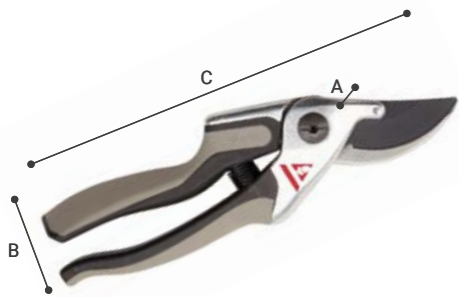

▶ TIJERA UNIVERSAL ALUMINIO TRIMATERIAL 3510

REF.	€	8 41 4299	g	A mm	B mm	C mm	Ø Corte	
3510-21	51,11	549775	3	280	20	60	210	25

Muy resistente y ergonómica.



▶ TIJERA UNIVERSAL ALUMINIO TRIMATERIAL 3512

REF.	€	8 41 4299	g	A mm	B mm	C mm	Ø Corte	
3512-21	54,08	576276	3	240	20	55	210	30
3512-22	54,08	576290	3	270	20	55	220	30

Especial ramas gruesas. Muy resistente y ergonómica.



▶ TIJERA FRUTALES ALUMINIO 3604

REF.	€	8 41 4299	g	A mm	B mm	C mm	Ø Corte	
3604-21	46,62	187892	3	255	20	60	220	25

Mangos de aluminio con recubrimiento antideslizante: ergonomía y ligereza. Poda frutal.



▶ TIJERA UNIVERSAL FORJADA 3504

REF.	€	8 41 4299	g	A mm	B mm	C mm	Ø Corte	
3504-23	43,25	143607	3	470	20	65	230	25

Forjada de una sola pieza muy robusta.



▶ TIJERA UNIVERSAL MANGO REMACHADO 3505

REF.	€	8 41 4299	g	A mm	B mm	C mm	Ø Corte	
3505-23	40,24	341416	3	330	20	55	230	25

Mangos de acero estampado, ligeros.

## TIJERAS DE UNA MANO DE JARDÍN- SMART

- Hojas y contrahojas con recubrimiento antiadherente para un corte limpio y sin esfuerzo.
- Cabeza de corte humillada para facilitar una postura cómoda de corte, sin forzar la inclinación de la mano.
- Bulón diseñado para un ajuste estable y preciso.
- Muelle estable que disminuye el cansancio.

### Usos:

- Para el cuidado y mantenimiento de las plantas y árboles en el jardín.

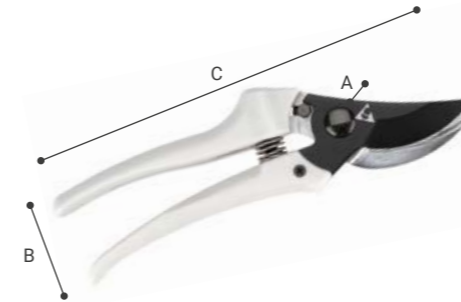

▶ TIJERA DE UNA MANO BYPASS SMART 3408

REF.	€	8 41 4299	g	A mm	B mm	C mm	Ø Corte	
3408	11,50	707144	3	188	195	60	25	20



▶ TIJERA BYPASS ERGONÓMICA SMART 3409

REF.	€	8 41 4299	g	A mm	B mm	C mm	Ø Corte	
3409	12,45	707168	3	170	205	65	25	20



▶ TIJERA YUNQUE SMART 3410

REF.	€	8 41 4299	g	A mm	B mm	C mm	Ø Corte	
3410	13,00	615654	3	187	195	65	25	20

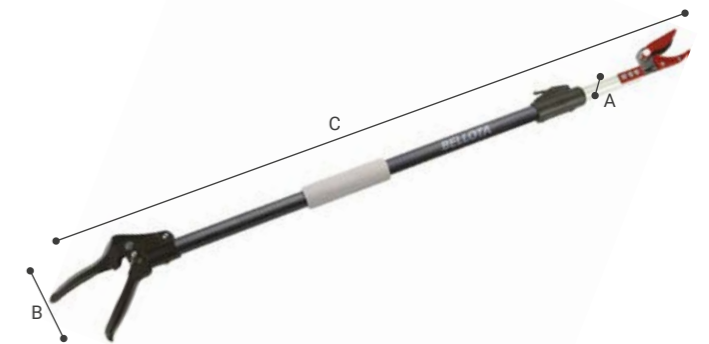

▶ TIJERA LARGO ALCANCE 3612

REF.	€	8 41 4299	g	A mm	B mm	C mm	Ø Corte	
3612	67,52	563344	2	820	25	65	1.020	10

Mecanismo de pinza para agarre de frutos desmontable. Sistema intercambiable pick y hold. Extensible.



▶ TIJERA FLORAL 3520

REF.	€	8 41 4299	g	A mm	B mm	C mm	Ø Corte	
3520	14,20	563368	6	110	15	90	205	15

Hojas de acero inoxidable. Hoja curvada y dentada para un corte limpio.

## TIJERAS DE UNA MANO-CLASSIC LINE

- Ángulos y afilados estudiados para un corte fácil y limpio.
- Hojas tratadas para evitar roturas y alargar la vida de la herramienta.
- Diseño clásico y robusto.
- Piezas de recambio disponibles.

### Usos:

- Para poda y recolección intensiva.



▶ TIJERA UNIVERSAL FORJADA 3501

REF.	€	8 41 4299	g	A mm	B mm	C mm	Ø Corte	
3501-18	12,15	160024	12	180	16	50	180	20
3501-18 BL	13,44	160444	6	170	20	40	180	20
3501-20	13,93	160086	6	280	20	55	210	22
3501-20 BL	15,70	160451	6	180	15	50	190	22
3501-22	15,71	160093	6	300	21	55	225	25
3501-22 BL	17,51	160468	6	300	20	60	220	25
3501-24	18,29	160109	6	400	21	60	240	25
3501-24 BL	20,31	160475	6	400	22	60	240	25
3501-26	21,15	078206	6	440	22	65	260	25



▶ TIJERA VENDIMIA FORJADA 3502

REF.	€	8 41 4299	g	A mm	B mm	C mm	Ø Corte	
3502-19	9,93	160116	12	170	14	50	190	25
3502-19 BL	11,60	160482	6	180	15	50	190	25



▶ TIJERA AJOS FORJADA 3503

REF.	€	8 41 4299	g	A mm	B mm	C mm	Ø Corte	
3503-19	12,67	160123	12	180	32	170	375	20
3503-19 BL	13,58	160499	6	180	16	38	200	20

## TIJERAS DE DOS MANOS-PROLINE

- Corte fácil y limpio: diseñadas para conseguir una perfecta penetración y deslizamiento de la hoja de corte en la rama.
- Hojas forjadas de Acero Especial Bellota de alta resistencia al desgaste para alargar la vida de la herramienta.
- Sistema de articulación AJUSTE FÁCIL PATENTADO para garantizar un ajuste de la tijera preciso, sencillo y estable en el tiempo.
- Amortiguadores EXTRA con mayor superficie de contacto para menor esfuerzo en el corte y menor fatiga
- Mangos de aluminio elípticos, con empuñadura SOFT TOUCH para mayor comodidad durante el trabajo, ligeros y ergonómicos.
- Todas las piezas de recambio están disponibles.

### Usos:

Para poda universal: viña, frutal y olivo.



▶ TIJERA UNIVERSAL 3578

REF.	€	8 41 4299	g	A mm	B mm	C mm	Ø Corte	
3578-40	64,96	580112	3	870	32	160	425	35
3578-45	67,69	549812	3	800	35	165	450	35
3578-50	70,49	549836	3	900	33	180	500	35
3578-60	73,24	549850	3	1.010	35	210	600	35
3578-75	75,33	588552	3	1.110	31	250	750	35
3578-90	76,79	567953	3	1.210	33	290	900	35

Para poda universal: viña, fruta y olivo.



▶ TIJERA FRUTALES 3580

REF.	€	8 41 4299	g	A mm	B mm	C mm	Ø Corte	
3580-60	66,00	501292	3	1.080	33	210	600	50
3580-75	67,50	588590	3	950	33	250	750	50
3580-90	68,58	566543	3	1.340	32	290	900	50

Para poda de frutal. Especial ramas grandes.



▶ TIJERA UNIVERSAL EXTENSIBLE 3578

REF.	€	8 41 4299	g	A mm	B mm	C mm	Ø Corte	
3578-TEL	76,73	613513	3	1.220	40	220	620	35

Para poda universal: viña, fruta y olivo. Mangos Extensibles de 60 a 90 cm.



▶ TIJERA UNIVERSAL DENTADA LIGERA 3588D

REF.	€	8 41 4299	g	A mm	B mm	C mm	Ø Corte	
3588D-50	66,95	579895	3	780	33	180	500	35
3588D-60	69,56	579918	3	850	35	210	600	35
3588D-75	71,56	011616	3	940	35	260	750	35

Modelo ligero. Para poda universal: viña, fruta y olivo. Contrahoja dentada: mayor estabilidad en el corte.



▶ TIJERA VIÑA LIGERA 3589

REF.	€	8 41 4299	g	A mm	B mm	C mm	Ø Corte	
3589-40	62,97	579932	3	700	35	155	415	30
3589-50	68,29	579956	3	720	35	180	500	30

Modelo ligero. Para poda de viña y punteo.



▶ TIJERA PÉRTIGA 3590

REF.	€	8 41 4299	g	A mm	B mm	C mm	Ø Corte	
3590	73,11	633399	4	1.300	35	110	430	35

Para poda universal: viña, fruta y olivo. Gran multiplicador de la fuerza x8. Sistema adaptable a cualquier pértiga mediante tornillo de rosca.



▶ TIJERA PÉRTIGA 3590

REF.	€	8 41 4299	g	A mm	B mm	C mm	Ø Corte	
3590-S	93,33	633412	4	1.420	35	150	420	35

Para poda universal: viña, fruta y olivo. Gran multiplicador de la fuerza x8. Sistema adaptable a cualquier pértiga mediante tornillo de rosca.

## CORTASETOS-PROLINE

- Corte fácil y limpio: diseñadas para conseguir una perfecta penetración y deslizamiento de la hoja de corte en la rama.
- Hojas forjadas de Acero Especial Bellota de alta resistencia al desgaste para alargar la vida de la herramienta.
- Mangos de aluminio elípticos, con empuñadura SOFT TOUCH para mayor comodidad durante el trabajo, ligeros y ergonómicos.
- Amortiguadores flexibles para menor esfuerzo en el corte y menor fatiga.

### Usos:

- Para recorte y mantenimiento de setos y arbustos.

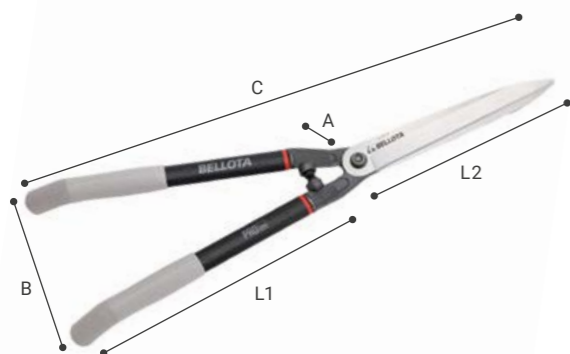

▶ CORTASETOS HOJA LARGA 3582

REF.	€	8 41 4299	g	A mm	B mm	C mm	L1 mm	L2 mm
3582	63,37	637472	3	1.170	50	215	690	267

Hojas de corte largas y rectas para zonas de difícil acceso.

## TIJERAS DE DOS MANOS-GARDEN LINE

- Hojas y contrahojas con recubrimiento antiadherente para un corte limpio y sin esfuerzo.
- Mangos ergonómicos, ligeros y equilibrados fabricados en poliamida reforzada. Empuñaduras de elastómero con acabado SOFT TOUCH para mayor comodidad.
- Amortiguadores EXTRA con mayor superficie de contacto para menor esfuerzo en el corte y menor fatiga.
- Bulón diseñado para un ajuste estable y preciso.

### Usos:

- Para poda de ramas gruesas, tanto verdes como secas, a diferentes alturas.



▶ TIJERA UNIVERSAL 3440

REF.	€	8 41 4299	g	A mm	B mm	C mm	Ø Corte	
3440-50	49,99	615531	3	890	40	200	510	35
3440-75	55,83	615555	3	1.020	31	270	750	35

Contrahoja dentada para mayor estabilidad y facilidad de corte.



▶ TIJERA UNIVERSAL EXTENSIBLE 3440

REF.	€	8 41 4299	g	A mm	B mm	C mm	Ø Corte	
3440-TEL	56,63	615517	3	1.130	36	230	610	35

Contrahoja dentada para mayor estabilidad y facilidad de corte. Mangos de aluminio telescópicos 60 cm-90 cm.



▶ TIJERA YUNQUE 3441

REF.	€	8 41 4299	g	A mm	B mm	C mm	Ø Corte	
3441-75	55,83	622522	3	1.000	30	260	750	45

Yunque de aluminio para menor desgaste. Yunque dentado.



▶ TIJERA YUNQUE EXTENSIBLE 3441

REF.	€	8 41 4299	g	A mm	B mm	C mm	Ø Corte	
3441-TEL	58,33	622546	3	1.180	37	220	620	45

Yunque de aluminio para menor desgaste. Mangos de aluminio telescópicos 60 cm-90 cm. Yunque dentado.



▶ TIJERA POWERCUT X 2 3442

REF.	€	8 41 4299	g	A mm	B mm	C mm	Ø Corte	
3442-75	64,17	622584	3	1.100	30	280	790	35

Sistema multiplicador de la fuerza.



▶ TIJERA POWERCUT X 2 3443

REF.	€	8 41 4299	g	A mm	B mm	C mm	Ø Corte	
3443-75	64,17	622560	3	1.100	30	285	750	35

Sistema multiplicador de la fuerza.

## CORTASETOS-GARDEN LINE

- Hojas y contrahojas con recubrimiento antiadherente para un corte limpio y sin esfuerzo.
- Mangos ergonómicos, ligeros y equilibrados fabricados en poliamida reforzada. Empuñaduras de elastómero con acabado SOFT TOUCH para mayor comodidad.
- Amortiguadores EXTRA con mayor superficie de contacto para menor esfuerzo en el corte y menor fatiga.
- Bulón diseñado para un ajuste estable y preciso.

### Usos:

- Para arreglar setos y arbustos en paisajismo.

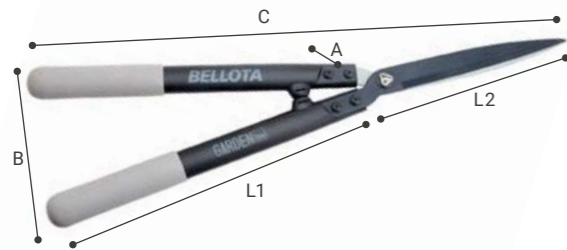

▶ CORTASETOS HOJA RECTA 3461

REF.	€	8 41 4299	g	A mm	B mm	C mm	L1 mm	L2 mm
3461-R	42,51	615616	3	1.000	30	190	660	645 230

Para corte de ramas finas y arreglo de setos y arbustos. Hoja recta.



▶ CORTASETOS HOJA RECTA EXTENSIBLE 3461

REF.	€	8 41 4299	g	A mm	B mm	C mm	L1 mm	L2 mm
3461-R TEL	49,60	635041	3	1.040	37	180	600	800 230

Mangos extensibles: 60 cm-80 cm.



▶ CORTASETOS HOJA CURVA 3461

REF.	€	8 41 4299	g	A mm	B mm	C mm	L1 mm	L2 mm
3461-C	42,51	615630	3	960	30	195	660	645 230

Para corte de ramas gruesas y arreglo de setos y arbustos con ramas dispersas. Hoja curva.

## CORTACÉSPED-GARDEN LINE

- Hojas y contrahojas con recubrimiento antiadherente para un corte limpio y sin esfuerzo.
- Hojas giratorias:
  - Horizontal: recortar y arreglar bordes.
  - Diagonal: áreas de difícil acceso.
  - Vertical: definir la forma.
- Mangos ergonómicos, ligeros y equilibrados.

### Usos:

- Para arreglar y recortar el césped.

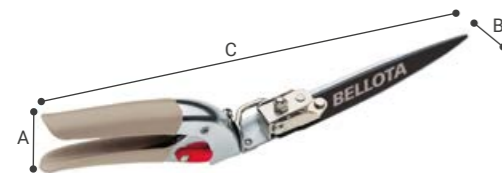

▶ CORTACÉSPED 3555

REF.	€	8 41 4299	g	A mm	B mm	C mm	L2 mm
3555	19,86	091328	6	410	25	60	340 15

Hoja giratoria.

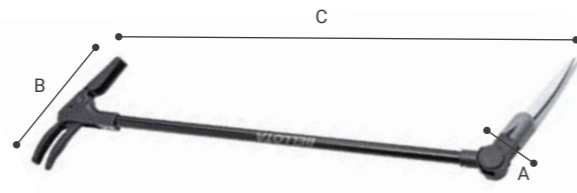

▶ CORTACÉSPED LARGO ALCANZE 3556

REF.	€	8 41 4299	g	A mm	B mm	C mm	L2 mm
3556	44,22	639155	2	1.070	70	270	1.000 14,5

Altura de trabajo 90 cm.

## REPUESTOS DE TIJERAS

### PROLINE-TIJERAS DE UNA MANO



#### ▶ REPUESTOS PARA TIJERA UNIVERSAL 3510

REF.	€	8 41 4299	g	Descripción	REF.
3510-H	17,50	551228	6	Hoja	3510
3510-CH	18,86	551242	6	Contrahoja	3510
3510-S	6,62	551280	6	Cierre	3510
3510-MA	10,08	551266	6	Muelles + amortiguador	3510
3510-BT	16,45	551303	6	Bulón + tuerca	3510
3510-21 H	10,17	551327	6	Mango hoja	3510-21
3510-21 C	10,17	551365	6	Mango contrahoja	3510-21
3510-22 H	11,92	551341	6	Mango hoja	3510-22
3510-22 C	10,17	551389	6	Mango contrahoja	3510-22



#### ▶ REPUESTOS PARA TIJERA UNIVERSAL 3512

REF.	€	8 41 4299	g	Descripción	REF.
3512-H	17,50	606294	6	Hoja	3512
3512-CH	18,86	606331	6	Contrahoja	3512
3512-MA	10,08	606317	6	Muelle + amortiguador	3512
3512-BT	16,45	606270	6	Bulón + tuerca	3512
3512-21 H	17,50	606355	6	Mango hoja	3512-21
3512-21 CH	18,86	606393	6	Mango contrahoja	3512-21
3512-22 H	13,43	017267	6	Mango hoja	3512-22
3512-22 CH	13,43	222067	6	Mango contrahoja	3512-22



#### ▶ REPUESTOS PARA TIJERA DE ACERO 3505-23

REF.	€	8 41 4299	g	Descripción	REF.
3505-H	12,50	618754	6	Hoja	3505-23
3505-CH	10,58	618730	6	Contra-hoja	3505-23
3505-BT	19,20	618716	6	Bulón + tuerca	3505-23
3505-MA	6,72	618778	6	Muelle y amortiguador	3505-23
3505-S	4,86	618792	6	Seguro de cierre	3505-23



► REPUESTOS PARA TIJERA FORJADA 3504-23

REF.	€	8 41 4299	📦		🔪
3504-H	12,50	373080	6	Hoja	3504-23
3504-CH	10,58	628043	6	Contra-hoja	3504-23
3504-S	4,86	628067	6	Seguro de cierre	3504-23
3510-BT	16,45	551303	6	Bulón + tuerca	3504-23
3505-MA	6,72	618778	6	Muelle y amortiguador	3504-23



► REPUESTOS PARA TIJERA DE ALUMINIO 3604

REF.	€	8 41 4299	📦		🔪
3604-21 H	9,29	264395	12	Hoja	3604-21
3510-BT	16,45	551303	6	Bulón + tuerca	3604-21

SMART-TIJERAS DE UNA MANO



► REPUESTOS PARA TIJERAS SMART

REF.	€	8 41 4299	📦		🔪
3408H	4,12	709926	1	Hoja	3408
3408CH	3,61	709940	1	Contrahoja	3408
3408M	1,55	709902	1	Muelle	3408/3409/3410
3409H	4,12	709964	1	Hoja	3409
3409CH	3,61	709988	1	Contrahoja	3409
3410H	3,61	710007	1	Hoja	3410
3410CH	4,12	717334	1	Contrahoja	3410

PROLINE-RECOLECTORAS



► REPUESTOS PARA TIJERAS RECOLECTORAS

REF.	€	8 41 4299	📦		🔪
3622 INOX-M	0,88	593723	12	Muelle + amortiguador	3621, 3622, 3623, 3624, 3625, 3628, 3629

PROLINE-TIJERAS DE DOS MANOS



► REPUESTOS PARA TIJERAS DE PODA UNIVERSAL

REF.	€	8 41 4299	📦		🔪
3578-H	23,11	551068	6	Hoja	3578, 3578D, 3578 TEL
3578-CH	23,88	551082	6	Contrahoja	3578, 3578 TEL
3578-CHD	27,54	551105	6	Contrahoja dentada	3578D
3578-A	6,47	551129	6	Kit amortiguadores	3578, 3578D, 3580, 3588D, 3589
3578-BT	16,45	551143	6	Bulón + tuerca	3578, 3578D, 3580, 3588D, 3589
3578-TTM	6,09	135329	6	Kit tornillos mangos	3578, 3578D, 3580, 3581, 3588D, 3589
3578-M40	31,04	028218	6	Mangos	3578, 3578D, 3580
3578-M45	31,04	551167	6	Mangos	3578, 3578D, 3580
3578-M50	31,04	551181	6	Mangos	3578, 3578D, 3580
3578-M60	31,04	551204	6	Mangos	3578, 3578D, 3580
3578-M75	33,90	594959	6	Mangos	3578, 3578D, 3580
3578-M90	34,07	231199	6	Mangos	3578, 3578D, 3580



► REPUESTOS PARA TIJERAS DE PODA UNIVERSAL EXTENSIBLE

REF.	€	8 41 4299	📦		🔪
3578-TELA	6,54	614152	6	Amortiguador	3578-TEL
3578-TELT	6,09	614282	6	Tornillos del mango	3578-TEL
3578-MTEL	39,88	614138	6	Mangos	3578-TEL



► REPUESTOS PARA TIJERAS DE PODA FRUTAL 3580

REF.	€	8 41 4299	📦		🔪
3580-H	23,11	566628	6	Hoja	3580
3580-CH	23,88	566642	6	Contrahoja	3580



► REPUESTOS PARA TIJERA DE YUNQUE FRUTAL 3581

REF.	€	8 41 4299	📦		🔪
3581-BM	25,16	593808	6	Brazo multiplicador	3581
3581-BT	17,35	046601	6	Bulón + tuerca + tornillo	3581
3581-CH	25,16	593754	6	Contrahoja	3581
3581-H	24,32	057713	6	Hoja	3581
3581-Y	17,91	593785	6	Yunque de aluminio	3581
3581-TA	10,26	360974	6	Tornillo + arandela + tuerca	3581
3581-TTC	8,69	611373	6	Tornillo pivotante + arandela	3581
3581-M	36,51	593822	6	Mangos	3581

\* Se pueden realizar pedidos unitarios de repuestos de tijeras con un recargo de 4 % en el precio marcado.

## GARDEN LINE-TIJERAS DE UNA MANO



## ▶ REPUESTOS PARA TIJERAS DE PODA UNIVERAL LIGERAS

REF.	€	8 41 4299	📦	🔪	
3588-H	22,07	579970	6	Hoja	3588D
3588D-CH	22,73	579994	6	Contrahoja dentada	3588D
3589-H	23,11	580013	6	Hoja	3589
3589-CH	23,88	580037	6	Contrahoja	3589
3588-M40	29,46	580051	6	Mangos	3588D, 3589
3588-M50	29,46	580075	6	Mangos	3588D, 3589
3588-M60	29,46	580099	6	Mangos	3588D, 3589
3588-M75	29,46	594973	6	Mangos	3588D, 3589



## ▶ REPUESTOS PARA PÉRTIGA 3590

REF.	€	8 41 4299	📦	🔪	
3590-H	23,91	633436	4	Hoja	
3590-M	9,56	633450	4	Muelle	
3590-BT	17,50	633474	4	Bulón + tuerca	
3590-C	14,34	633498	4	Cuerda	
3590-P	6,70	633511	4	Polea	
3590-A	12,45	633559	4	Abrazadera	
3590-CH	39,21	633573	4	Kit contrahoja	

## PROLINE-CORTASETOS



## ▶ REPUESTOS PARA CORTASETOS 3584

REF.	€	8 41 4299	📦	🔪	
3583-A	3,18	124859	6	Kit amortiguadores	3584, 3582
3583-T	10,07	125092	6	Tornillo + tuerca	3584, 3582



## ▶ REPUESTOS PARA TIJERAS DE UNA MANO

REF.	€	8 41 4299	📦	🔪	
3612-H	8,85	084214	1	Hoja de repuesto	3612

## GARDEN LINE-TIJERAS DE DOS MANOS



## ▶ REPUESTOS PARA TIJERAS DE DOS MANOS

REF.	€	8 41 4299	📦	🔪	
3440-HT	12,74	627909	6	Hoja de repuesto	3440-50, 3440-75
3440-TEL-HT	12,74	627923	6	Hoja de repuesto	3440-TEL
3441-HT	12,74	627947	6	Hoja de repuesto	3441-50, 3441-75
3441-TEL-HT	12,74	627961	6	Hoja de repuesto	3441-TEL
3440-B	8,85	627985	6	Bulón tijera dos manos	3440-50, 3440-75, 3440-TEL, 3441-50, 3441-75, 3441-TEL, 3461R
3441-YT	8,85	628029	6	Yunque de repuesto	3441-50, 3441-75, 3441-TEL
3442-HT	13,80	639056	6	Hoja de repuesto	3442
3443-HT	13,80	639070	6	Hoja de repuesto	3443
3443-YT	8,62	639117	6	Yunque de repuesto	3443
3578-TELA	6,54	614152	6	Amortiguador	3440, 3441, 3442, 3443, 3461R, 3461C, 3461RTEL, 3461RMM

## CLASSIC LINE-TIJERAS DE UNA MANO

## ▶ REPUESTOS PARA TIJERAS FORJADAS

REF.	€	8 41 4299	📦	🔪	
R3501-18	1,55	093506	24	Muelle	3501-18, 3502-19, 3503-19
R3501-20	1,63	093544	24	Muelle	3501-20, 3501-22
R3501-24	1,89	093582	24	Muelle	3501-24, 3501,26

## COMPLEMENTOS



## ▶ AFILADOR 3642

REF.	€	8 41 4299	📦	g	A mm	B mm	C mm
3642	13,44	091694	12	50	5	15	130

Para el afilado de cualquier herramienta de corte o poda. Pastilla de carburo de tungsteno.



# SERRUCHOS

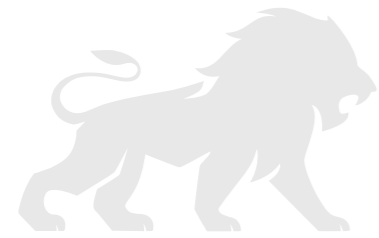

## LA GAMA CLASSIC CUT

Está especialmente diseñada para las personas que trabajan con fuerza y buen ritmo.

- **Hoja rígida** de acero especial laminado y dentado japonés afilado por las tres caras.
- **Corte agresivo, el de toda la vida.**
- Temple extraduro en los dientes.



## LA GAMA EXPERT CUT

Está especialmente diseñada para las personas experimentadas que buscan un corte limpio y un movimiento fluido.

- **Hoja flexible** de acero especial laminado y dentado japonés afilado por las tres caras.
- **Corte rápido, suave y limpio.**
- Temple extraduro en los dientes.

	VELOCIDAD DE CORTE	INTENSIDAD DE USO	FACILIDAD DE CORTE	ACABADO FINO	HOJA FLEXIBLE	DURABILIDAD
CLASSIC CUT 	▲▲	▲▲▲	▲▲▲	▲	▲▲	▲▲▲
EXPERT CUT 	▲▲▲	▲▲▲	▲▲	▲▲▲	▲▲▲	▲▲▲



PARA SABER MÁS...



# PERSONALIZA TU SERRUCHO EN 3 PASOS

## 01 ELIGE TU HOJA

### ▶ HOJA CLASSIC CUT CURVA

Para el corte de ramas por encima del hombro.



11 PULGADAS / 280MM



13 PULGADAS / 330MM

### ▶ HOJA EXPERT CUT CURVA

Para el corte de ramas por encima del hombro.



11 PULGADAS / 280MM



13 PULGADAS / 330MM

### ▶ HOJA EXPERT CUT RECTA

Para el corte de ramas por encima del hombro.



9 PULGADAS / 228MM



12 PULGADAS / 304MM

## 02 ELIGE TU MANGO

### ▶ MANGO CURVO

Mantenemos la forma tradicional, pero alargamos el mango para que te quepa bien en la mano.



### ▶ MANGO RECTO

Para sujetar la herramienta más firmemente.



## 03 ELIGE TU FUNDA

### ▶ FUNDA CURVA

Para las hojas curvas.

**GATILLO DE SEGURIDAD**  
Desbloqueo con una sola mano.

AMBIDIESTRO

**ANCLAJE RÁPIDO DE HEBILLA Y HEBILLA GIRATORIA.**

**AGUJERO FIN DE FUNDA**  
Gran apertura para evacuar suciedad.

### ▶ FUNDA RECTA

Para las hojas rectas.

**ANCLAJE RÁPIDO DE HEBILLA Y HEBILLA GIRATORIA.**

**AGUJERO FIN DE FUNDA**  
Gran apertura para evacuar suciedad.

# SERRUCHOS DE PODA

## SERRUCHOS DE AGRICULTURA



**NEW**

► SERRUCHO LEÓN CON HOJA CURVA Y MANGO DE BIMATERIAL CURVO 450BIMC

REF.	€	8 41 4299	g	A mm	B mm	C mm	L mm	Nº	
450BIMC11	21,30	028904	6	378	51	123	431	11"	6,4
450BIMC13	22,30	028935	6	395	51	123	481	13"	6,4
450BIMC13SF	15,50	028973	6	268	51	123	478	13"	6,4
H45011	11,04	030846	6	90	1,8	79	314	11"	6,4
H45013	12,33	030860	6	100	1,8	99	364	13"	6,4

\* SF: Sin Funda



**NEW**

► SERRUCHO LEÓN CON HOJA CURVA Y MANGO DE BIMATERIAL RECTO 450BIMR

REF.	€	8 41 4299	g	A mm	B mm	C mm	L mm	Nº	
450BIMR11	21,30	028706	6	378	51	123	442	11"	6,4
450BIMR13	22,30	028744	6	395	51	123	492	13"	6,4
450BIMR13SF	15,50	028829	6	268	51	123	489	13"	6,4
H45011	11,04	030846	6	90	1,8	79	314	11"	6,4
H45013	12,33	030860	6	100	1,8	99	364	13"	6,4

\* SF: Sin Funda



**NEW**

► SERRUCHO LEÓN CON HOJA CURVA Y MANGO DE MADERA CURVO 450MC

REF.	€	8 41 4299	g	A mm	B mm	C mm	L mm	Nº	
450MC11	19,50	027945	6	348	51	123	431	11"	6,4
450MC13	20,50	028027	6	365	51	123	481	13"	6,4
450MC13SF	15,00	028645	6	238	51	123	478	13"	6,4
H45011	11,04	030846	6	90	1,8	79	314	11"	6,4
H45013	12,33	030860	6	100	1,8	99	364	13"	6,4

\* SF: Sin Funda



**NEW**

► SERRUCHO LEÓN CON HOJA CURVA Y MANGO DE MADERA RECTO 450MR

REF.	€	8 41 4299	g	A mm	B mm	C mm	L mm	Nº	
450MR11	19,50	027792	6	348	51	123	442	11"	6,4
450MR13	20,50	027822	6	365	51	123	492	13"	6,4
450MR13SF	15,00	027907	6	238	51	123	489	13"	6,4
H45011	11,04	030846	6	90	1,8	79	314	11"	6,4
H45013	12,33	030860	6	100	1,8	99	364	13"	6,4

\* SF: Sin Funda



**NEW**

► SERRUCHO GUEPARDO CON HOJA CURVA Y MANGO DE BIMATERIAL CURVO 454BIMC

REF.	€	8 41 4299	g	A mm	B mm	C mm	L mm	Nº	
454BIMC11	22,50	030082	6	368	51	123	431	11"	6,4
454BIMC13	23,50	030136	6	385	51	123	481	13"	6,4
454BIMC13SF	18,40	030174	6	258	51	123	478	13"	6,4
H45411	14,09	030945	6	80	1,3	77	311	11"	6,4
H45413	16,30	031195	6	90	1,3	96	360	13"	6,4

\* SF: Sin Funda



**NEW**

► SERRUCHO GUEPARDO CON HOJA CURVA Y MANGO DE BIMATERIAL RECTO 454BIMR

REF.	€	8 41 4299	g	A mm	B mm	C mm	L mm	Nº	
454BIMR11	22,50	029499	6	368	51	123	442	11"	6,4
454BIMR13	23,50	029895	6	385	51	123	492	13"	6,4
454BIMR13SF	18,40	029987	6	258	51	123	489	13"	6,4
H45411	14,09	030945	6	80	1,3	77	311	11"	6,4
H45413	16,30	031195	6	90	1,3	96	360	13"	6,4

\* SF: Sin Funda



**NEW**

► SERRUCHO GUEPARDO CON HOJA CURVA Y MANGO DE MADERA CURVO 454MC

REF.	€	8 41 4299	g	A mm	B mm	C mm	L mm	Nº	
454MC11	21,50	029154	6	338	51	123	431	11"	6,4
454MC13	22,50	029390	6	355	51	123	481	13"	6,4
454MC13SF	17,50	029451	6	228	51	123	478	13"	6,4
H45411	14,09	030945	6	80	1,3	77	311	11"	6,4
H45413	16,30	031195	6	90	1,3	96	360	13"	6,4

\* SF: Sin Funda



**NEW**

► SERRUCHO GUEPARDO CON HOJA CURVA Y MANGO DE MADERA RECTO 454MR

REF.	€	8 41 4299	g	A mm	B mm	C mm	L mm	Nº	
454MR11	21,50	028997	6	338	51	123	442	11"	6,4
454MR13	22,50	029055	6	355	51	123	492	13"	6,4
454MR13SF	17,50	029093	6	228	51	123	489	13"	6,4
H45411	14,09	030945	6	80	1,3	77	311	11"	6,4
H45413	16,30	031195	6	90	1,3	96	360	13"	6,4

\* SF: Sin Funda



**NEW**

► SERRUCHO GUEPARDO CON HOJA RECTA Y MANGO BIMATERIAL RECTO 45RBIMR

REF.	€	8 41 4299	g	A mm	B mm	C mm	L mm	Nº	
45RBIMR9	23,50	033519	6	352	26	107	415	9"	6,4
45RBIMR12	25,50	030761	6	382	26	107	474	12"	6,4
H45R9	14,09	031249	6	70	1,3	737	292	9"	6,4
H45R12	16,30	031362	6	90	1,3	39	347	12"	6,4

\* SF: Sin Funda



**NEW**

► SERRUCHO GUEPARDO CON HOJA RECTA Y MANGO DE MADERA RECTO 45RMR

REF.	€	8 41 4299	g	A mm	B mm	C mm	L mm	Nº	
45RMR9	22,50	030211	6	322	26	107	415	9"	6,4
45RMR12	24,50	030594	6	352	26	107	474	12"	6,4
H45R9	14,09	031249	6	70	1,3	737	292	9"	6,4
H45R12	16,30	031362	6	90	1,3	39	347	12"	6,4

\* SF: Sin Funda



**NEW**

► SERRUCHO PLEGABLE GUEPARDO CON HOJA CURVA DE 7" Y MANGO RECTO 45PBIM7

REF.	€	8 41 4299	g	A mm	B mm	C mm	L mm	Nº	
45PBIM7	17,50	030808	6	190	25	60	230	7"	6,1
H45P7	6,60	031522	6	40	1,3	36	211	7"	6,1

\* SF: Sin Funda



► SERRUCHO RECTO PARA RAMAS Y RAICES 3011

REF.	€	8 41 4299	g	A mm	B mm	C mm	L mm	Nº	
3011	24,01	089943	6	160	25	60	310	165	3

Hoja cónica recubierta de cromo para mayor suavidad y velocidad de corte. Hoja recta



► SERRUCHO CURVO MANGO METÁLICO 4587

REF.	€	8 41 4299	g	A mm	B mm	C mm	L mm	Nº	
4587-13 MM	38,10	464092	6	300	27	55	540	13"	6

\* SF: Sin Funda



► SERRUCHO CURVO MANGO METÁLICO 3014

REF.	€	8 41 4299	g	A mm	B mm	C mm	L mm	Nº	
3014 HM	32,88	567205	4	450	35	100	600	13"	6

Hoja con punta curvada que facilita el corte de ramas en alturas difíciles de alcanzar. Hoja curva.

## PÉRTIGAS

- Fabricadas con Acero Especial Bellota.
- Dentado japonés afilado por tres caras para mayor facilidad y limpieza de corte.
- Doble tratamiento térmico para conseguir un mayor rendimiento: temple integral en la hoja y temple extra-duro en los dientes.
- 8 puntos de bloqueo mediante pestillos se mantiene fijo y sin holguras en cada posición.

### Usos:

- Para la poda de plantas leñosas, plantas y árboles ornamentales.
- Para poda en altura.

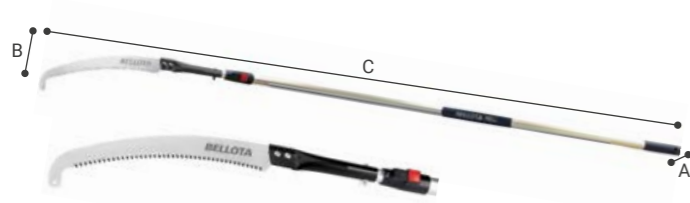

► PÉRTIGA PROLINE P4580

REF.	€	8 41 4299	g	A mm	B mm	C mm	
P4580-13	82,39	582734	3	1.360	50	165	2.260

Extensible de 2,2 a 3,2 m. Serrucho curvo con punta curvada que facilita el corte de ramas en alturas difíciles de alcanzar.



► PÉRTIGA PROLINE P4587

REF.	€	8 41 4299	g	A mm	B mm	C mm	
P4587-13	65,89	582758	3	1.330	380	500	2.230

Extensible de 2,2 a 3,2 m. Serrucho curvo.



► PÉRTIGA GARDEN LINE 3014

REF.	€	8 41 4299	g	A mm	B mm	C mm	
3014	63,10	563306	6	1.150	50	140	2.090

Serrucho dentado japonés para mayor facilidad y limpieza de corte. Hoja con punta curvada para corte de ramas en alturas difíciles de alcanzar. Incluye

## REPUESTOS



REF.	€	8 41 4299	g		
3631 M	14,43	124965	1	20	Muelle pértiga 3631
3630	30,69	582772	3	980	Mango extensible P4580-13 / P4587-13 / 3590 / 3590S

## HOJAS DE ARCO

- Fabricadas con Acero Especial Bellota.
- Dientes con mayor altura del temple por inducción de alta frecuencia para una mayor durabilidad.
- Altura homogénea de los dientes para aumentar resistencia y rendimiento.
- Hojas de corte más rígidas y consistentes. Corte más recto, más fácil y más seguro.

### Usos:

- Para corte de madera y ramas en general.
- Para poda y limpieza de plantas leñosas principalmente árboles frutales y arbustos.

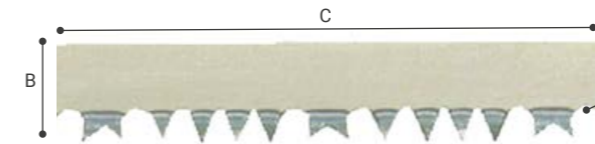

► HOJA DENTADO AMERICANO 4535

REF.	€	8 41 4299	g	A mm	B mm	C mm	
4535-21	2,70	314397	12	30	2	20	525
4535-24	2,85	314403	12	50	3	40	600
4535-30	2,95	314410	12	60	3	20	770

Dentado americano, para corte de madera en verde.



► HOJA DENTADO AMERICANO FINO 4536

REF.	€	8 41 4299	g	A mm	B mm	C mm	
4536-21	2,77	032703	12	39	0,9	18	525
4536-24	2,92	032741	12	50	1	20	600
4536-30	3,03	032789	12	60	1	20	750

Dentado americano fino, para corte limpio de madera en verde.



► HOJA DENTADO UNIVERSAL 4537

REF.	€	8 41 4299	g	A mm	B mm	C mm	
4537-21	2,70	314427	12	40	3	40	540
4537-24	2,85	314434	12	50	3	20	600
4537-30	3,03	314441	12	60	3	40	770

Dentado universal, para corte de madera seca.



► HOJA DENTADO UNIVERSAL FINO 4538

REF.	€	8 41 4299	g	A mm	B mm	C mm	
4538-21	2,77	439793	12	50	2	25	520

Dentado universal fino, para corte limpio de madera seca.

## SIERRAS DE ARCO

- Arco con sistema de anclaje especial Bellota fijación rápida, segura y cómoda.
- Corte recto y fácil, la hoja se mantiene centrada y derecha durante el corte.
- Dientes templados por inducción de alta frecuencia para una mayor durabilidad.
- Altura homogénea de los dientes para aumentar resistencia y rendimiento.

### Usos:

- Para corte de madera y ramas en general.
- Para poda y limpieza de plantas leñosas principalmente árboles frutales y arbustos.
- Para labores de encofrado.



▶ SIERRA DE ARCO DENTADO AMERICANO FINO 45391

REF.	€	8 41 4299	g	A mm	B mm	C mm
45391-21	8,76	710861	12	460	25	210
45391-24	9,44	710885	12	540	25	220
45391-30	10,09	710908	12	756	25	235

Dentado americano fino, para corte limpio de madera en verde.



▶ SIERRA ARCO DENTADO UNIVERSAL 4540

REF.	€	8 41 4299	g	A mm	B mm	C mm
45401-21	8,76	710922	12	460	25	210
45401-24	9,44	710946	12	540	25	220
45401-30	10,09	710960	12	756	25	235

Dentado universal, para corte de madera seca.

## UN ARCO PARA CADA MEDIDA

Para medida de 21



Para medida de 24



Para medida de 30



# HACHAS

## HACHAS PARA LEÑA

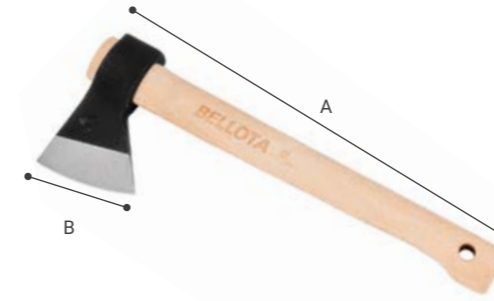

▶ HACHA VIZCAÍNA 8130 C

REF.	€	8 41 4299	g	A mm	B mm	C mm	M
8130-1000C	36,81	708097	6	1.350	42	170	600 P81302 M81301000
8130-300C	21,68	707977	6	500	30	119	380 P81301 M8130300C
8130-400C	23,86	707991	6	630	30	128	380 P81301 M8130400C
8130-500C	26,19	708011	6	730	32	133	400 P81301 M8130500C
8130-600C	27,98	708035	6	815	34	142	400 P81302 M8130600C
8130-700C	30,60	708059	6	1.000	34	151	450 P81302 M8130700C
8130-800C	32,61	708073	6	1.080	35	158	450 P81302 M8130700C
8130-1200C	38,97	708110	6	1.660	43	180	700 P81303 M81301200
8130-1500C	43,87	708134	6	2.070	46	195	800 P81303 M81301500
8130-2000C	51,61	708158	6	2.615	49	215	800 P81303 M81302000

▶ HACHA PODA 8131

REF.	€	8 41 4299	g	A mm	B mm	C mm	M
8131-300	38,25	835762	6	630	30	165	480 M8131300 M5938SB
8131-300 SM	28,46	835793	24	440	30	165	65 M8131300 M5938SB

Para limpieza y poda de frutales cítricos.

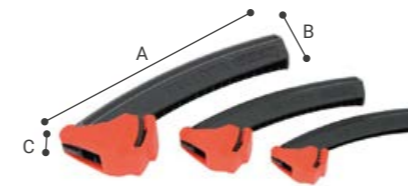

▶ PROTECTOR UNIVERSAL DE HACHAS 8130

REF.	€	8 41 4299	g	A mm	B mm	C mm	Destino
P8130-1	3,91	661965	6	12	15,2	90	115,6 3480 8130300C 8130400C 8130500C
P8130-2	4,89	661996	6	25	20	110	145 8130600C 8130700C 8130800C 81301000C
P8130-3	5,88	662023	6	50	50	140	190 81301200C 81301500C 81302000C

## CUADRO ORIENTATIVO SOBRE LAS MEDIDAS DE HACHA QUE ENTRAN EN EL PROTECTOR

300N	78-95 mm	
400N		
500N		
600N	99-113 mm	
700N		
800N		
1000N		
1200N	124-148 mm	
1500N		
2000N		
2000N		

Especialmente diseñado para el hacha vizcaína Bellota y apta para geometrías similares.

## HACHA DE PODA

- Cabeza forjada de acero con recubrimiento antiadherente, con muesca que permite sacar fácilmente clavos.
- Mango inyectado sobre cabeza para una unión perfecta. Mango ligero de fibra de vidrio hueco.

### Usos:

- Para corte de leña y madera en general, limpieza de árboles y poda



► HACHA GARDEN LINE 3480

REF.	€	8 41 4299	g	A mm	B mm	C mm	M
3480	63,13	637526	3	780	20	130	400 P81301

## MAZA CUÑAS

- Fabricadas en acero Especial Bellota
- Forjadas de una sola pieza, irrompibles.
- Tratamiento térmico 3+ para alargar la vida útil de la herramienta no se rompe, no se deforma, no se desgasta.
- Perfecta unión cabeza mango para garantizar la seguridad del usuario.
- Diseño especial del filo para asegurar una buena penetración en la madera.
- Pintura y barniz especiales para evitar la oxidación de la herramienta.
- Dos tipos de mangos:
  - Mangos de madera de haya, ligeros y de tacto agradable. Certificado PEFC.
  - Mangos de fibra de carbono irrompibles. Diseño ergonómico, con recubriendo SOFT TOUCH para mayor comodidad durante el trabajo.

### Usos:

- Mazas-Cuñas para corte de madera gruesa y dura. Doble uso como maza con una cuña, y como hacha para el corte de madera.
- Cuñas para cortar y romper la madera, se usa con maza o maza cuña.

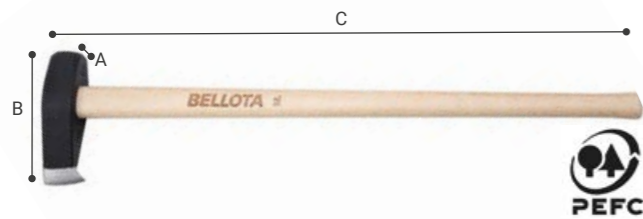

► MAZA-CUÑA 5460

REF.	€	8 41 4299	g	A mm	B mm	C mm	M
5460-3	68,62	124002	6	3.580	70	210	895 M54603

Para preparar leña.



► MAZA-CUÑA 5460

REF.	€	8 41 4299	g	A mm	B mm	C mm	M
5460-3 CF	77,94	625257	6	3.990	70	210	900 M52006CF

Para preparar leña.

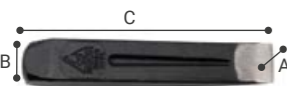

► CUÑA 5461

REF.	€	8 41 4299	g	A mm	B mm	C mm
5461-1	24,35	124101	6	1.000	35	185
5461-1,5	30,54	124200	6	1.500	40	210
5461-2	36,74	124309	6	1.970	45	225
5461-2,5	41,22	124408	6	2.500	48	255
5461-3	46,80	124507	6	2.880	52	270

## MACHETES

- Fabricados con acero Especial Bellota.
- Hojas laminadas, cónicas para mayor durabilidad y facilidad de corte.
- Óptima dureza, flexibilidad y resistencia.
- La hoja llega hasta el final del mango.
- Tres tipologías de mangos:
  - Mangos de madera barnizados, ligeros y de tacto agradable.
  - Mango bimaternal ergonómico y antideslizante para mayor comodidad y seguridad.
  - Mango de plástico de polipropileno de alto impacto.

### Usos:

- Para corte de matorrales, rastrojos y ramas pequeñas.
- Para corte de diversos cultivos cañas de azúcar, café.

B: Espesor de la hoja mm .

PBM: Pulido Bimaternal Mango

PBMA: Pulido Bimaternal Mango afilado

PMM: Pulido Mango Madera PPN: Pulido Plástico Negro

NMM: Natural Mango Madera.

Nota: Todas las referencias de Machetes son contra pedido, salvo las que van marcadas con \*.

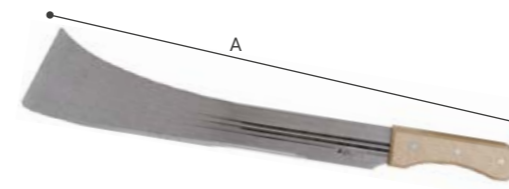

► MACHETE 202

REF.	€	8 41 4299	Pallet	g	A inches/mm	B mm
202-19,5-3 PMM	7702956007753	60	1.620	831	19,5"/ 495	3



► MACHETE 204

REF.	€	8 41 4299	Pallet	g	A inches/mm	B mm
204-18-3 PMM	7702956020158	60	1.620	758	18"/ 457	3



► MACHETE 1778

REF.	€	8 41 4299	Pallet	g	A inches/mm	B mm
1778-18-2,4 PMM	7702956020165	60	1.620	614	18"/ 457	2,4
1778-22-2,4 PMM	7702956006978	60	1.620	685	22"/ 559	2,4



► MACHETE 368

REF.	€	8 41 4299	Pallet	g	A inches/mm	B mm
368-16-3 PMM	7702956019930	60	1.620	565	16"/ 406	2,4



► MACHETE 448

REF.	€	8 41 4299	Pallet	g	A inches/mm	B mm
448-21-3 PMM	7702956020172	60	1.620	792	21"/ 533	3



► MACHETE 443

REF.	€	8 41 4299	Pallet	g	A inches/mm	B mm
443-18-3 PMM	7702956011446	60	1.620	700	18"/ 457	3



► MACHETE 244

REF.	8 41 4299	Pallet	g	A inches/mm	B mm
244-18-3 PMM	7702956020141	60	1.560	677 18"/ 457	3



► MACHETE 1055

REF.	8 41 4299	Pallet	g	A inches/mm	B mm
1055-22-3 PPN	7702956019916	60	1.620	510 22"/ 559	3



► MACHETE W550

REF.	8 41 4299	Pallet	g	A inches/mm	B mm
W550-22-3 PMM	7702956020202	60	1.620	583 22"/ 559	3



► MACHETE 1779

REF.	8 41 4299	Pallet	g	A inches/mm	B mm
1779-22-2,4 PMM	7702956007241	60	1.620	635 22"/ 559	2,4



► MACHETE 31W

REF.	8 41 4299	Pallet	g	A inches/mm	B mm
31W-14-2 PMM	7702956020264	60	1.620	366 14"/ 356	2
31W-16-2 PMM	7702956020271	60	1.620	385 16"/ 406	2
31W-18-2 PMM	7702956020288	60	1.620	436 18"/ 457	2
31W-20-2 PMM	7702956020295	60	1.620	485 20"/ 508	2
31W-22-2 PMM	7702956009702	60	1.620	495 22"/ 559	2



► MACHETE 410

REF.	8 41 4299	Pallet	g	A inches/mm	B mm
410-19,5-3 PMM	7702956020189	60	1.620	570 19,5"/ 495	3



► MACHETE 741

REF.	8 41 4299	Pallet	g	A inches/mm	B mm
741-18-3 PMM	7702956020196	60	1.560	710 18"/ 457	3



► MACHETE 638

REF.	8 41 4299	Pallet	g	A inches/mm	B mm
638-16-3 PMM	7702956019954	60	1.620	575 16"/ 406	3



► MACHETE 31B

REF.	€	8 41 4299	Pallet	g	A inches/mm	B mm
31B-14-2 PPN		7702956020219	60	1.620	340 14"/ 356	2
31B-16-2 PPN		7702956020226	60	1.620	370 16"/ 406	2
31B-18-2 PPN		7702956020233	60	1.620	395 18"/ 457	2
* 31B-20-2 PPN	26,90	968002	12	576	450 20"/ 508	2
31B-22-2 PPN		7702956020257	60	1.620	470 22"/ 559	2



► MACHETE 127H

REF.	8 41 4299	Pallet	g	A inches/mm	B mm
127H-16-2 PPN	7702956020301	60	1.620	365 16"/ 406	2
127H-18-2 PPN	7702956020318	60	1.620	408 18"/ 457	2
127H-20-2 PPN	7702956020325	60	1.620	433 20"/ 508	2
127H-22-2 PPN	7702956020332	60	1.620	463 22"/ 559	2
127H-24-2 PPN	7702956020349	60	1.620	495 24"/ 610	2



► MACHETE 2127H

REF.	8 41 4299	Pallet	g	A inches/mm	B mm
2127H-16-2 PBM	7702956020356	60	1.620	373 16"/ 406	2
2127H-18-2 PBM	7702956020363	60	1.620	420 18"/ 457	2
2127H-20-2 PBM	7702956020370	60	1.620	450 20"/ 508	2
2127H-22-2 PBM	7702956020387	60	1.620	470 22"/ 559	2
2127H-24-2 PBM	7702956020394	60	1.620	510 24"/ 610	2



► MACHETE 2127F

REF.	8 41 4299	Pallet	g	A inches/mm	B mm
2127F-16-2 PBM	7702956020455	60	1.620	373 16"/ 406	2
2127F-18-2 PBM	7702956020462	60	1.620	420 18"/ 457	2
2127F-20-2 PBM	7702956020479	60	1.620	450 20"/ 508	2
2127F-22-2 PBM	7702956020486	60	1.620	470 22"/ 559	2
2127F-24-2 PBM	7702956020493	60	1.620	510 24"/ 610	2



► MACHETE 2460

REF.	8 41 4299	Pallet	g	A inches/mm	B mm
2460-16-2 PBM	7702956020554	60	1.620	370 16"/ 406	2
2460-18-2 PBM	7702956020561	60	1.620	410 18"/ 457	2
2460-20-2 PBM	7702956020578	60	1.620	425 20"/ 508	2
2460-22-2 PBM	7702956020585	60	1.620	460 22"/ 559	2
2460-24-2 PBM	7702956020592	60	1.620	480 24"/ 610	2



► MACHETE 2128F

REF.	8 41 4299	Pallet	g	A inches/mm	B mm
2128F-18-2 PPN	7702956020646	60	1.620	401 18"/ 457	2
2128F-20-2 PPN	7702956020653	60	1.620	450 20"/ 508	2
2128F-22-2 PPN	7702956020660	60	1.620	477 22"/ 559	2
2128F-24-2 PPN	7702956020677	60	1.620	507 24"/ 610	2



► MACHETE 127F

REF.	8 41 4299	Pallet	g	A inches/mm	B mm
127F-16-2 PPN	7702956020400	60	1.620	365 16"/ 406	2
127F-18-2 PPN	7702956020417	60	1.620	408 18"/ 457	2
127F-20-2 PPN	7702956020424	60	1.620	433 20"/ 508	2
127F-22-2 PPN	7702956020431	60	1.620	463 22"/ 559	2
127F-24-2 PPN	7702956020448	60	1.620	495 24"/ 610	2



► MACHETE 460

REF.	8 41 4299	Pallet	g	A inches/mm	B mm
460-16-2 PPN	7702956020509	60	1.620	370 16"/ 406	2
460-18-2 PPN	7702956020516	60	1.620	395 18"/ 457	2
460-20-2 PPN	7702956020523	60	1.620	440 20"/ 508	2
460-22-2 PPN	7702956020530	60	1.620	470 22"/ 559	2
460-24-2 PPN	7702956020547	60	1.620	500 24"/ 610	2



► MACHETE 128F

REF.	8 41 4299	Pallet	g	A inches/mm	B mm
128F-18-2 PPN	7702956020608	60	1.620	395 18"/ 457	2
128F-20-2 PPN	7702956020615	60	1.620	444 20"/ 508	2
128F-22-2 PPN	7702956020622	60	1.620	470 22"/ 559	2
128F-24-2 PPN	7702956020639	60	1.620	500 24"/ 610	2



► MACHETE 32L

REF.	8 41 4299	Pallet	g	A inches/mm	B mm
32L-16-3 PMM	7702956009764	60	1.620	492 16"/ 406	3
32L-18-3 PMM	7702956009795	60	1.620	553 18"/ 457	3
32L-20-3 PMM	7702956009825	60	1.620	594 20"/ 508	3
32L-22-3 PMM	7702956009856	60	1.620	649 22"/ 559	3
32L-24-3 PMM	7702956009887	60	1.620	747 24"/ 610	3



► MACHETE 350

REF.	€	8 41 4299	Pallet	g	A inches/mm	B mm
* 350-14-2 PMM	<b>32,90</b>	200478	12 864 490	14"/ 356	2	
* 350-16-2 PMM	<b>31,95</b>	200546	12 540 518	16"/ 406	2	
350-18-2 PMM		7702956020707	60 1.620 555	18"/ 457	2	
* 350-20-2 PMM	<b>26,90</b>	200614	12 576 550	20"/ 508	2	
350-22-2 PMM		7702956020721	60 1.620 595	22"/ 559	2	



► MACHETE 1002

REF.	€	8 41 4299	Pallet	g	A inches/mm	B mm
1002-14-1,8 PMM		7702956020738	60 1.620 592	14"/ 356	1,8	



► MACHETE 1004

REF.	€	8 41 4299	Pallet	g	A inches/mm	B mm
1004-14-1,8 PMM		7702956020745	60 1.620 612	14"/ 356	1,8	



► MACHETE 1060

REF.	€	8 41 4299	Pallet	g	A inches/mm	B mm
1060-11-1,3 PMM		7702956020769	60 1.620 494	11"/ 279	1,3	



► MACHETE 781

REF.	€	8 41 4299	Pallet	g	A inches/mm	B mm
781-26-2 NMM		7702956015079	60 1.620 469	26"/ 660	2	



► MACHETE 5813

REF.	€	8 41 4299	Pallet	g	A inches/mm	B mm
5813-1,6 NMM		7702956020776	100 2.700 172	6"/ 152	1,6	



► MACHETE 465

REF.	€	8 41 4299	Pallet	g	A inches/mm	B mm
* 465-12 PBMA	<b>55,76</b>	620139	12 864 250	12"/ 304	1,8	

# GUADAÑAS

- Fabricados con acero Especial Bellota.
- Templadas y tensionadas para un corte perfecto.
- Filo con picado especial para garantizar un espesor homogéneo a lo largo de toda la herramienta.
- Incluye protector del filo para mayor seguridad.

**Usos:**

- Para siega en general. Especialmente indicadas para zonas pequeñas o difíciles.

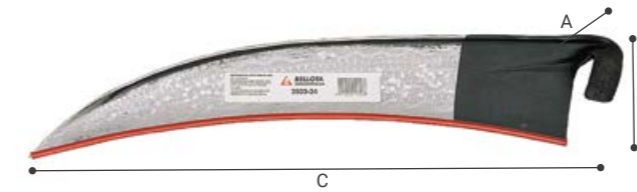

► GUADAÑA 2503

REF.	€	8 41 4299	g	A mm	B mm	C mm	M	L mm
2503-20	<b>81,84</b>	116700	6	710	80	125	600	M2503R 510
2503-22	<b>84,15</b>	116809	6	780	50	600	130	M2503R 560
2503-24	<b>89,90</b>	116908	6	760	80	130	700	M2503R 610
2503-26	<b>95,48</b>	117004	6	1.020	90	150	760	M2503R 660



► GUADAÑA 2506

REF.	€	8 41 4299	g	A mm	B mm	C mm	M	L mm
2506-20	<b>87,86</b>	117707	6	760	95	175	580	M2503R 510
2506-22	<b>91,83</b>	117806	6	770	90	180	620	M2503R 560



► GUADAÑA 2509

REF.	€	8 41 4299	g	A mm	B mm	C mm	M	L mm
2509-22	<b>81,62</b>	118308	6	590	70	100	645	M2503R 578
2509-24	<b>84,89</b>	118407	6	650	80	110	670	M2503R 610
2509-26	<b>88,82</b>	118506	6	670	70	110	750	M2503R 660
2509-28	<b>93,87</b>	118605	6	730	70	100	800	M2503R 707

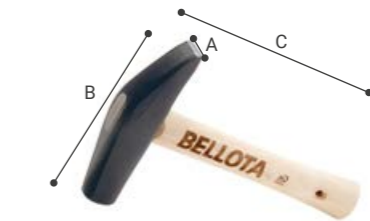

► MARTILLO PICAR GUADAÑAS 1071

REF.	€	8 41 4299	g	A mm	B mm	C mm	
1071	<b>36,93</b>	116205	6	720	34	130	200

Para afilar y picar guadañas, junto con el yunque para garantizar el buen afilado de la guadaña.

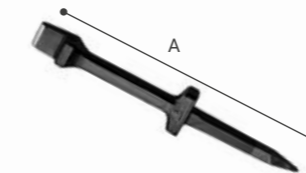

► YUNQUE PICAR GUADAÑAS 1051

REF.	€	8 41 4299	g	A mm	B mm	C mm	
1051	<b>69,10</b>	115703	12	1.650	40	65	400

Para afilar y picar guadañas, junto con el martillo para garantizar el buen afilado de la guadaña.

# HOCES

- Fabricadas con acero Especial Bellota.
- Hojas laminadas, cónicas para mayor durabilidad y facilidad de corte.
- Dos modelos de hoja:
  - Hoja dentada: picada por una cara y esmerilada por la otra, y templada por inducción.
  - Hoja de filo: esmerilada por ambas caras y templadas integralmente.
- Con protector de filo para mayor seguridad.
- Mango de madera ligero y barnizado.

**Usos:**

- Para siega en zonas pequeñas o difíciles con una sola mano. Para corte de hierba y maleza.

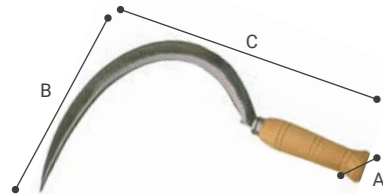

▶ HOZ DENTADA 2550

REF.	€	8 41 4299	g	A mm	B mm	C mm	L mm
2550-000 N	11,54	159899	6	196	40	320	370 22
2550-00 N	11,75	159905	6	200	32	330	394 22
2550-0 N	12,38	159912	6	310	32	340	421 22
2550-1 N	12,79	159929	6	220	33	290	437 22
2550-2 N	13,12	159936	6	240	33	210	370 22



▶ HOZ DENTADA 2551

REF.	€	8 41 4299	g	A mm	B mm	C mm	L mm
2551	12,88	158588	6	230	40	230	460 22



▶ HOZ DENTADA 2552

REF.	€	8 41 4299	g	A mm	B mm	C mm	L mm
2552	13,24	158595	6	220	55	33	450 22



▶ HOZ FILO 2560

REF.	€	8 41 4299	g	A mm	B mm	C mm	L mm
2560-0	22,73	158601	6	260	40	380	400 39
2560-1	22,91	158618	6	300	40	390	445 41
2560-2	24,03	158625	6	330	32	240	430 43
2560-3	25,97	159943	6	390	32	285	460 45



▶ HOZ FILO 2561

REF.	€	8 41 4299	g	A mm	B mm	C mm	L mm
2561	28,30	158632	6	500	40	500	515 48



▶ HOZ FILO 2562

REF.	€	8 41 4299	g	A mm	B mm	C mm	L mm
2562	21,29	158649	6	250	40	360	440 36



▶ HOZ FILO 2563

REF.	€	8 41 4299	g	A mm	B mm	C mm	L mm
2563	25,89	158656	6	250	34	210	380 36



# TAJAMATAS

- Fabricadas con acero Especial Bellota.
- Tratamiento térmico 3+ para alargar la vida útil de la herramienta no se rompe, no se deforma, no se desgasta.
- Afilado de precisión para un corte limpio y homogéneo.

**Usos:**

- Para el corte de malezas y zarzas.
- Para poda profunda y limpieza de ramas.
- Para limpieza de palmeras.

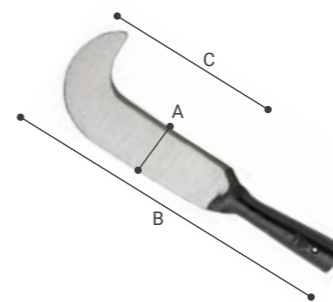

▶ TAJAMATA 1111

REF.	€	8 41 4299	g	A mm	B mm	C mm	L mm
1111-A	71,04	116403	12	870	42	400	132 70

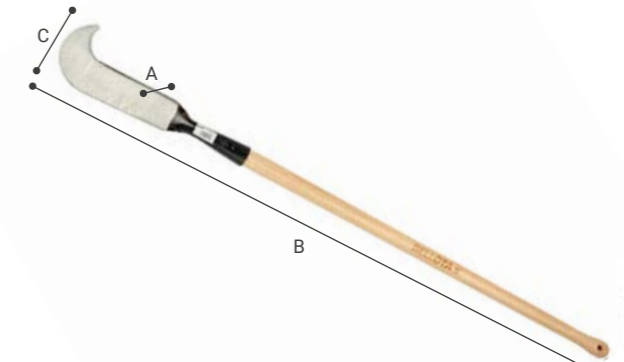

▶ TAJAMATA CON MANGO 1111

REF.	€	8 41 4299	g	A mm	B mm	C mm	L mm
1111-A CM	83,31	652024	2	870	42	400	132 70



▶ TAJAMATA 1116

REF.	€	8 41 4299	g	A mm	B mm	C mm	L mm
1116	94,38	116502	12	780	115	365	210 60



▶ TAJAMATA CON MANGO 1116

REF.	€	8 41 4299	g	A mm	B mm	C mm	L mm
1116 CM	106,67	652048	2	780	115	365	210 60



▶ TAJAMATA 1118

REF.	€	8 41 4299	g	A mm	B mm	C mm	L mm
1118-A	52,80	116601	12	770	38	140	300 140



▶ TAJAMATA CON MANGO 1118

REF.	€	8 41 4299	g	A mm	B mm	C mm	L mm
1118-A CM	67,37	652062	2	770	38	140	300 140





# LIMAS DE AGRICULTURA

- Fabricadas con acero Especial Bellota.
- Forjadas en una sola pieza, irrompibles.
- Tratamiento térmico 3+ para alargar la vida útil de la herramienta: no se rompe, no se deforma, no se desgasta.
- Nivel de dureza estudiado para cada lima en función del trabajo a realizar para conseguir la máxima duración.
- Dentado uniforme en función del tipo de picado para obtener el mejor resultado.
- Posibilidad de incorporar mango bimaternal ergonómico con acabado SOFT TOUCH para mayor comodidad durante el trabajo.

## LIMAS AFILADO

- Para afilar machetes, azadas, sierras y toda clase de útiles agrícolas.

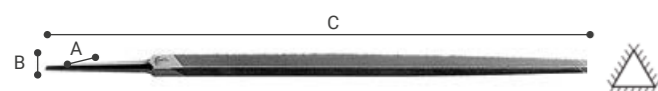

### LIMA EXTRADELGADA PARA SIERRA 4040

REF.	€	8 41 4299	g	A mm	B mm	C mm	L1 mm	L2 mm	M	
4040-5	8,76	431605	12	20	6	6	165	5 / 125	4,8	40902 4093B5 40891
4040-6	9,20	431803	12	30	8	7	195	6 / 150	6,1	40892 40903 4093B4

Lima triangular.



### LIMA DELGADA PARA SIERRA 4041

REF.	€	8 41 4299	g	A mm	B mm	C mm	L1 mm	L2 mm	M	
4041-4	6,99	432305	12	20	5,5	5,5	135	4 / 100	6,9	4093B5 40891
4041-5	7,12	432701	12	20	7	7	165	5 / 125	7	40892 40902 4093B5
4041-6	7,72	432909	12	50	9	9	195	6 / 150	9	40892 40903 4093B3
4041-7	8,50	433104	12	70	10	10	225	7 / 175	10	40893 40904 4093B3
4041-8	10,54	433302	12	90	11	11	255	8 / 200	11	40893 40904 4093B2

Lima triangular.



### LIMA NORMAL PARA SIERRA 4042

REF.	€	8 41 4299	g	A mm	B mm	C mm	L1 mm	L2 mm	M	
4042-3 V	6,40	433609	12	10	6	6	112	3 / 75	6	4093B5 40891
4042-4 V	6,47	434002	12	30	9	9	138	4 / 100	9	40892 4093B4
4042-5 V	7,27	434606	12	50	11	11	170	5 / 125	11	40893 40902 4093B3
4042-6 V	8,53	435009	12	70	10	10	196	6 / 150	10	40893 40903 4093B3
4042-7 V	9,93	435405	12	110	13	12	235	7 / 175	12	40893 40904 4093B3
4042-8 V	11,03	435801	12	140	14	14	245	8 / 200	14	40894 40904 4093B2
4042-9 V	12,95	436204	12	240	17	17	301	9 / 225	17	40894 40905 4093B2
4042-10 V	14,53	436501	12	270	17	17	321	10 / 250	17	40897 40905 4093B1

Lima triangular.



### LIMA NORMAL PARA SIERRA MANGO BIMATERIAL 4042

REF.	€	8 41 4299	g	A mm	B mm	C mm	L1 mm	L2 mm	M	
4042-3 V MB	8,54	136944	6	80	30	30	225	3 / 75	6	4093B5
4042-4 V MB	8,31	137262	6	90	30	30	225	4 / 100	9	40892 4093B4
4042-5 V MB	9,73	137019	6	110	30	30	249	5 / 125	11	40893 40902 4093B3
4042-6 V MB	10,45	130973	6	130	30	30	276	6 / 150	10	40893 40903 4093B3
4042-7 V MB	12,18	136692	6	160	32	32	300	7 / 175	12	40893 40904 4093B3
4042-8 V MB	13,47	136760	6	200	30	30	322	8 / 200	14	40894 40904 4093B2

Lima triangular.



### LIMA PARA SIERRA MANGO BIMATERIAL 4045

REF.	€	8 41 4299	g	A mm	B mm	C mm	L1 mm	L2 mm	M	
4045-6 1CR MB	15,91	137330	6	120	30	30	280	150	-	4093B5
4045-8 1CR MB	18,57	137392	6	160	32	32	330	200	-	4093B4

Lima sierra.



### LIMA REDONDA PARA MOTOSIERRA 4050

REF.	€	8 41 4299	g	A mm	B mm	C mm	L1 mm	L2 mm	M	
4050-8x4,0	1,56	442601	12	20	4	4	245	8 / 200	4	4093B4
4050-8x4,5	1,56	469363	12	20	4	4	246	8 / 200	4	4093B4
4050-8x4,8	1,56	442502	12	30	5	5	246	8 / 200	5	4093B4
4050-8x5,5	1,56	442700	12	40	5	5	245	8 / 200	5	4093B4
4050-8x4,0 BS	3,44	612059	6	20	4	4	248	8 / 200	4	4093B4
4050-8x4,5 BS	3,44	612073	6	20	4	4	245	8 / 200	4	4093B4
4050-8x4,8 BS	3,44	612097	6	30	4	4	246	8 / 200	4	4093B4
4050-8x5,5 BS	3,44	612110	6	40	5	5	246	8 / 200	5	4093B4
4050-8x3,2	1,56	673715	12	10	3	3	247	8 / 200	3	4093B4
4050-8x3,6	1,56	673975	12	10	3	3	245	8 / 200	3	4093B4

BS: con bolsa con dos limas. Lima redonda.



### LIMA TRIANGULAR PARA MACHETE 4081

REF.	€	8 41 4299	g	A mm	B mm	C mm	L1 mm	L2 mm	M	
4081-5	6,72	466607	12	60	11	11	171	5 / 125	11	40893 40902 4093B3
4081-6	7,58	466706	12	70	11	11	195	6 / 150	11	40894 40903 4093B3
4081-7	9,13	466805	12	110	14	14	235	7 / 175	14	40894 40904 4093B3
4081-8	11,09	466904	12	140	14	15	260	8 / 200	15	40894 40904 4093B2
4081-10	14,58	469233	12	250	18	18	327	10 / 250	18	40897 40905 4093B1

Lima triangular.

# ESCOFINAS

1

▶ **No te fallan:**

Fabricadas con Acero Especial Bellota para que no te fallen en ningún momento.

2

▶ **Máxima precisión:**

Diseñadas para preparar la pezuña con mayor confort y conseguir un acabado perfecto.

3

▶ **Mayor rendimiento:**

Picado y afilado concebido para que puedas eliminar el máximo material en el menor tiempo posible.

### CARACTERÍSTICAS

- El afilado de las Escofinas Bellota prepara la pezuña con velocidad y confort y logra alcanzar la máxima precisión y delicadeza.
- La zona picada proporciona un raspado agresivo para eliminar el máximo material con el mínimo esfuerzo sin embotarse. Con el borde de la raspa y la cara de la lima se consigue un acabado perfecto y liso.
- Reafiladas por ambos lados para un rendimiento más rápido y agresivo.

### USOS

- Para herrar caballos y ponis.

GEOMETRÍA UNIFORME DE LOS DIENTES.

ACERO DE ALEACIÓN CROMO ESPECIAL BELLOTA.

TRATAMIENTO TÉRMICO INTEGRAL.

TECNOLOGÍA EXCLUSIVA DE AFILADO BELLOTA.

Ref. 41371415RAF

# SI TIENES CLARO LO QUE NECESITAS, ENCUENTRA TU ESCOFINA



	ESCOFINA											
Corte extremo	▲	▲	▲									
Basto				▲	▲	▲	▲	▲				
Agresivo									▲	▲	▲	
	LIMA											
Súper basto												
Basto	▲	▲	▲									▲
Entrefino												
Fino				▲	▲	▲	▲		▲	▲		
Extra fino								▲			▲	▲
ELIGE LA ESCOFINA QUE MEJOR SE ADAPTE A TI												
Dimensiones (Longitud+anchura+altura)	5x45x430	5x57x430	507x57x5	5x45x430	5x45x330	5x45x355	5x45x406	5x45x430	4,5x50x430	4,5x50x457	4,5x50x430	5x45x430
Peso (g)	622	828	1.013	622	415	593	678	622	653	780	653	620
Pulgadas de la zona de trabajo	14"	14"	17"	14"	8"	14"	16"	14"	14	17"	14"	14"
NÚMERO DE DIENTES POR FILA												
6 dientes normales	▲			▲	▲	▲	▲	▲				▲
8 dientes anchos									▲	▲	▲	
8 dientes extra anchos		▲	▲									

# ESCOFINAS

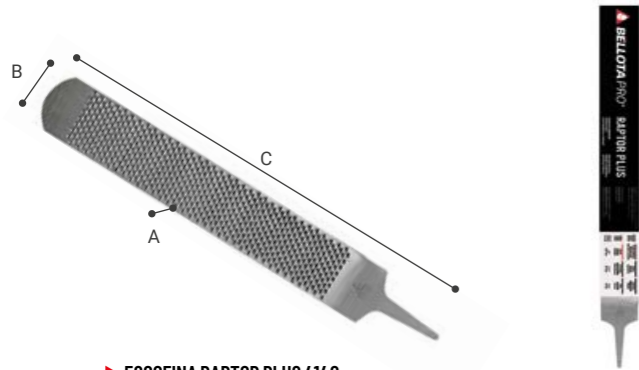

▶ ESCOFINA RAPTOR PLUS 4140

REF.	€	g	A mm	B mm	C mm	L mm
41401418RAF	51,45	7500372015204	6	828	5	57 430



▶ ESCOFINA PRIME FINISH PLUS 4139

REF.	€	g	A mm	B mm	C mm	L mm
41391417RAF	38,20	7500372015174	6	620	5	45 430

\* Bajo pedido.

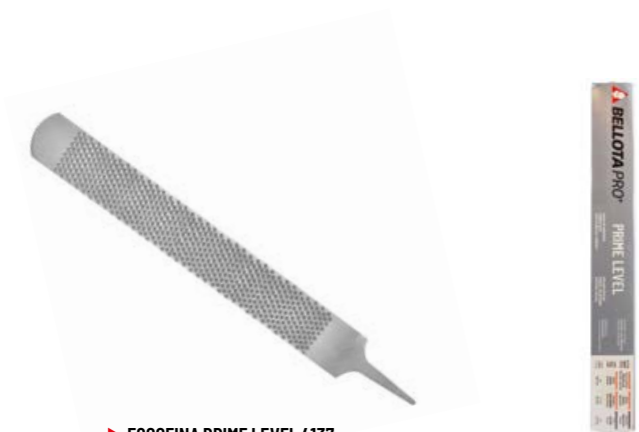

▶ ESCOFINA PRIME LEVEL 4137

REF.	€	g	A mm	B mm	C mm	L mm
41371415RAF	45,38	7500372015112	6	653	4,5	50 430

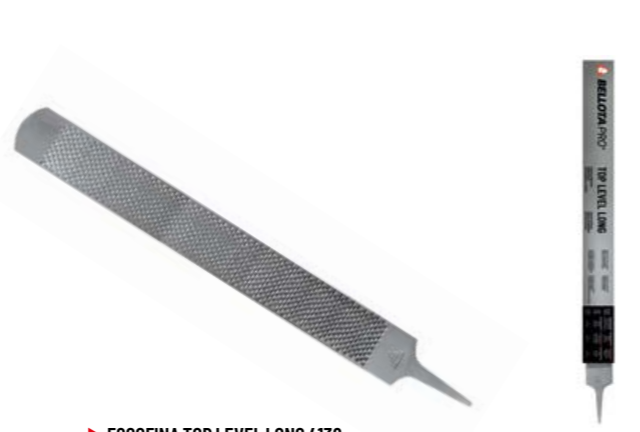

▶ ESCOFINA TOP LEVEL LONG 4138

REF.	€	g	A mm	B mm	C mm	L mm
41381716RAF	45,38	7500372015143	6	780	4,5	50 457



▶ ESCOFINA TOP LEVEL 4136

REF.	€	g	A mm	B mm	C mm	L mm
413614RAF	45,38	7500372014511	6	653	4,5	50 430



▶ ESCOFINA 4132 CLASSIC

REF.	€	g	A mm	B mm	C mm	L mm
4132148RAF	42,69	7500372009340	6	622	5	45 430

Acabado fino. Lima plana. Cuatro caras.



▶ ESCOFINA 4132 TOP SHARP

REF.	€	g	A mm	B mm	C mm	L mm
4132147RAF	42,69	7500372009319	6	622	5	45 430

Acabado rápido. Lima plana. Cuatro caras.



▶ ESCOFINA DOS MANOS 4133

REF.	€	g	A mm	B mm	C mm	L mm
41331411RAF	46,98	7500372009364	6	593	5	45 355
41331611RAF	51,44	7500372010902	6	678	5	45 406

Lima plana. Cuatro caras.



▶ ESCOFINA 4131 RAZOR PLUS

REF.	€	g	A mm	B mm	C mm	L mm
4131142RAFP	46,62	7500372009999	6	622	5	45 430



▶ ESCOFINA MINI CON MANGO

REF.	€	g	A mm	B mm	C mm	L mm
413208RAFMB	37,25	7500372010414	4	415	5	45 330



▶ ESCOFINA BIG RAPTOR PLUS

REF.	€	g	A mm	B mm	C mm	L mm
RFA411PA	51,80	7500372706161	6	1.013	5	57 507

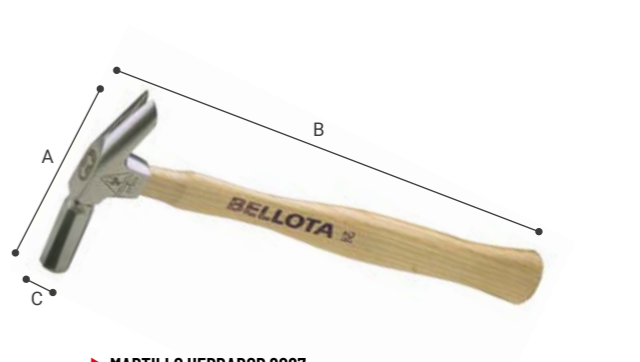

▶ MARTILLO HERRADOR 8027

REF.	€	g	A mm	B mm	C mm	L mm
8027	41,84	144604	6	240	24	110 310
8027SM	26,47	144703	12	170		



▶ MANGO MADERA PARA RASPAS 4090-7

REF.	€	g	A mm	B mm	C mm
4090-7	6,12	184341	24	110	50 50 100



▶ MANGO MADERA PARA RASPAS 4090-7 NG

REF.	€	g	A mm	B mm	C mm
4090-7NG	6,12	184341	24	110	50 50 100



▶ MANGO BIMATERIAL PARA RASPAS 7HDLA5BM

REF.	€	g	A mm	B mm
7HDLA5BM	7,25	7750037212747	12	110 119 33

# ACCESORIOS PARA LA AGRICULTURA

## GUANTES

- Materiales innovadores y diseños cómodos adaptados a cada tarea.
- Diferentes texturas para proteger las manos de manera óptima sin perder sensibilidad.

### Usos:

- Para realizar las principales tareas en el cuidado del jardín: trasplante, poda, mantenimiento, riego, fumigación



### ▶ GUANTE CONFORT 75101

REF.	€	8 41 4299	g	A mm	B mm	C mm	Mbox	Talla
75101-7/S	6,16	534344	10	50	20	120	260	120 7/S
75101-8/M	6,16	533989	10	50	15	120	235	120 8/M
75101-9/L	6,16	534009	10	50	20	90	230	120 9/L

Nylon 100%. Recubrimiento de nitrilo en palma. Puño elástico. Para trasplantes y labores de mantenimiento en el jardín.



### ▶ GUANTE GRIP 75102

REF.	€	8 41 4299	g	A mm	B mm	C mm	Mbox	Talla
75102-8/M	6,42	534023	10	50	20	110	220	120 8/M
75102-9/L	6,25	534047	10	70	20	110	230	120 9/L
75102-10/XL	6,25	534061	10	67	10	110	275	120 10/XL

Nylon 100%. Recubrimiento rugoso de látex en la palma. Puño elástico. Para trasplantes y labores de mantenimiento en el jardín.



### ▶ GUANTE HYDRO 75103

REF.	€	8 41 4299	g	A mm	B mm	C mm	Mbox	Talla
75103-8/M	4,98	534085	10	78	20	140	380	100 8/M

Nitrilo verde. Interior flocado de 0,38mm. Longitud 33 cm. Para trasplante de plantas; y trabajos varios en ambientes húmedos en el jardín.



### ▶ GUANTE UNIVERSAL 75104

REF.	€	8 41 4299	g	A mm	B mm	C mm	Mbox	Talla
75104-7/S	6,42	534122	10	45	10	100	220	120 7/S
75104-8/M	6,42	534146	10	50	10	100	225	120 8/M
75104-9/L	6,25	534160	10	60	20	110	230	120 9/L
75104-10/XL	6,25	534184	10	60	10	110	250	120 10/XL

Piel flor cabra gris grosor 0,7-0,9 mm. Dorsal de algodón y pulgar en ala. Elástico en muñeca. Para labores de mantenimiento.



### ▶ GUANTE 4X4 75105

REF.	€	8 41 4299	g	A mm	B mm	C mm	Mbox	Talla
75105-8/M	7,46	534207	10	125	20	120	270	120 8/M
75105-9/L	7,46	534221	10	110	20	130	250	120 9/L
75105-10/XL	7,26	534245	10	138	20	120	240	120 10/XL

Piel flor vacuno gris. Dorsal en serraje gris. Elástico en muñeca. Para labores de poda. Trabajos exigentes.



### ▶ GUANTE PROTECT 75106

REF.	€	8 41 4299	g	A mm	B mm	C mm	Mbox	Talla
75106-9/L	10,36	534283	10	130	20	130	470	60 9/L
75106-10/XL	10,36	534306	10	140	20	140	500	60 10/XL
75106-8/M	10,36	534269	10	120	20	130	380	60 8/M

Piel flor cabra gris. Dorsal en algodón verde y pulgar en ala. Manguito extralargo en loneta verde con ajuste superior. Para poda de árboles, arbustos y plantas espinosas.

## RODILLERAS



### ▶ RODILLERAS DE JARDÍN KPGATS

REF.	€	8 41 4299	g	A mm	B mm	C mm	Talla
KPGATS	11,26	705089	6	140	250	200	70 Única

## LUBRICANTES

- Mezclas optimizadas para mejorar el rendimiento de las máquinas.

### Usos:

- Para engrasar todo tipo de piezas.



### ▶ LUBRICANTE PARA CADENAS DE MOTOSIERRA 3660

REF.	€	8 41 4299	g	A mm	B mm	C mm	ml
3660	12,95	299397	20	970	75	110	220 1000

Para la lubricación de cadenas con cuchillas de corte en sierras mecánicas y motosierras.



### ▶ LUBRICANTE SINTÉTICO PARA MOTORES DE 2 Y 4 TIEMPOS 3661

REF.	€	8 41 4299	g	A mm	B mm	C mm	ml
3661-2T	17,26	299519	20	980	70	115	220 1000
3661-4T	17,63	299595	20	960	70	115	220 1000

Especialmente indicado para los motores de dos tiempos, tanto los refrigerados con aire como por agua: motocicletas, motocultores, ciclomotores, motosierras, corta césped.



### ▶ LUBRICANTE MULTIUSO 6660

REF.	€	8 41 4299	g	A mm	B mm	C mm	ml
6660	9,66	299458	24	210	53	53	175 270

Afloja, lubrica y protege.



### ▶ LUBRICANTE AFLOJATODO 6661

REF.	€	8 41 4299	g	A mm	B mm	C mm	ml
6661	10,93	299762	24	220	53	53	170 270

Desbloquear y soltar toda clase de tornillos, tuercas, pernos, pasadores, uniones roscadas, etc. Liberar mecanismos agarrotados. Desmontar piezas y accesorios oxidados y afectados por la corrosión.



### ▶ LUBRICANTE GRASA BLANCA LITIO 6662

REF.	€	8 41 4299	g	A mm	B mm	C mm	ml
6662	15,38	299854	12	370	66	66	210 400

Para hacer frente aquellas problemáticas de lubricación de mecanismos que deban trabajar de -55 a 150 °C, sin perder sus propiedades lubricantes. Mantiene un film lubricante que evita el contacto directo metal-metal entre las superficies a lubricar, a pesar de la fuerte variación de las condiciones de trabajo.

## GRASAS DE LITIO



### ▶ GRASA LITIO MULTIUSO 6663

REF.	€	8 41 4299	g	A mm	B mm	C mm	ml
6663	9,00	299915	24	150	47	80	165 150

Para rodamientos que trabajen a temperaturas y cargas muy elevadas.



### ▶ GRASA LITIO 3662

REF.	€	8 41 4299	g	A mm	B mm	C mm	ml
3662-1	19,41	605877	12	1.180	115	115	160 1000
3662-5	64,88	299717	4	5.530	190	190	270 5000

Para rodamientos de bolas y rodillos, cojinetes y todo tipo de elementos que tengan un campo de aplicación entre -20 a 120°C.

# PULVERIZADORES

## PULVERIZADORES DE MOCHILA

- Depósito estanco sin perforaciones y roscas más largas para evitar posibles fugas.
- Alto rendimiento, gracias al diseño de la cámara que permite un menor número de bombeos.
- Boquilla de alta calidad que garantiza un pulverizado uniforme. Incluye boquilla de cono regulable.
- Máxima comodidad, los tirantes regulables incluyen almohadilla comfort.
- Presión de funcionamiento de 1 a 3 bares.
- Longitud de lanza 60 centímetros. Longitud de manguera 120 centímetros.

### Usos:

- Para abono y fumigación en agricultura y jardinería.



► PULVERIZADOR MOCHILA 12/16 LITROS 3710

REF.	€	8 41 4299	g	A mm	B mm	C mm	
3710-16	59,40	604993	1	3.400	150	420	610
3710-12	56,67	443578	1	3.200	150	400	550

Incluye boquilla de abanico

\* Bomba de presión, especialmente diseñada para su uso: para abono y fumigación en agricultura y jardinería

\*\* En Construcción, NO UTILIZAR CON PRODUCTOS AGRESIVOS, como aceites, lubricantes, desencofrantes, disolventes, detergentes y desincrustantes.

► PULVERIZADOR PROFESIONAL 5/10 LITROS 3710

REF.	€	8 41 4299	g	A mm	B mm	C mm	
3710-10	52,56	606751	1	1.750	200	200	570
3710-05	33,33	688887	1	950	200	200	570

## REPUESTOS



REF.	€	8 41 4299	g	Destino
R3710-1	10,00	606652	1	Lanza y boquilla
R3710-2	6,83	606669	1	Maneta
R3710-3	12,35	606676	1	Manguera
R3710-4	5,04	606683	1	Bomba 12 y 16 litros
R3710-5	3,96	606690	1	Varios 12 y 16 litros. Émbolo, anillos
R3710-6	11,35	606706	1	Cámara de aire 16 litros
R3710-7	10,86	606713	1	Cámara de aire 12 litros
R3710-8	7,79	606720	1	Bomba 10 litros
R3710-9	6,43	606737	1	Varilla de bomba 10 litros
R3710-10	4,37	606744	1	Varios 10 litros. Émbolo, diafragma, anillo, muelle
R3710-11	10,23	706277	1	Manguera 5 litros

## PULVERIZADOR DE MANO

- Mangos con traba para pulverizar de manera continua y sin esfuerzo.
- Boquilla regulable que permite pulverizar desde una fina brisa hasta un chorro de largo alcance.
- Fácil mantenimiento y limpieza.

### Usos:

- Para regar y proteger plantas, rosas, flores y vegetales.
- Para eliminar malas hierbas y moho en muebles de jardín, columpios, etc.



► PULVERIZADOR PRESIÓN PREVIA 1/1,5/2 LITROS 3700

REF.	€	8 41 4299	g	A mm	B mm	C mm	
3700-015	17,83	460117	1	350	120	180	305
3700-010	10,83	691108	12	340	120	180	295
3700-020	19,61	691122	12	360	120	180	310

## CAPAZOS

- Fabricados con polietileno 100% reciclado y de gran calidad. Capazos duraderos, estables, de fácil limpieza y con una alta resistencia térmica y química.
- Resistirán todos los impactos. Gran flexibilidad y ligereza que facilita el transporte de materiales y el apilado. Además, el interior y las asas están reforzadas para evitar roturas.
- Con certificado alimentario para garantizar el transporte de frutas y verduras.

### Usos:

- Para el transporte de escombro, agua y áridos en sectores agrícolas y construcción.
- Con certificado alimentario fruta y verdura.

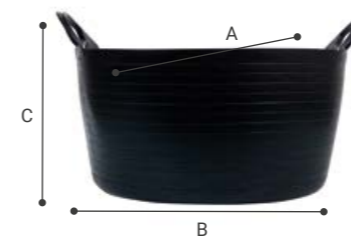

► CAPAZO NEGRO DE PLÁSTICO 30L

REF.	€	8 41 4299	g	A mm	B mm	C mm	L	
BKT30BP	5,12	676570	12	630	475	420	280	30



► CAPAZO ROJO DE PLÁSTICO 42L

REF.	€	8 41 4299	g	A mm	B mm	C mm	L	
BKT42RP	6,51	676655	12	980	520	450	380	42



► CAPAZO BLANCO PARA USO ALIMENTARIO

REF.	€	8 41 4299	g	A mm	B mm	C mm	L	
BKT42WP	10,54	676891	12	890	520	450	370	42
BKT65WP	15,24	677096	6	1.410	560	615	400	65



► CAPAZO AZUL PARA USO ALIMENTARIO

REF.	€	8 41 4299	g	A mm	B mm	C mm	L	
BKT42BLP	10,54	676969	12	890	520	450	380	42
BKT65BLP	15,24	677010	6	1.420	560	615	400	65

# HIDROLIMPIADORAS

1

## ▶ Amplitud de gama:

La gama de hidrolimpiadoras Bellota ofrece diferentes caudales y presiones, para adaptarse al uso requerido.

2

## ▶ Versatilidad:

Disponen de diferentes boquillas que permitirán ajustar la salida de agua a la superficie que se desea limpiar: boquilla turbo para concentrar la presión, una boquilla regulable y un rociador de espuma ajustable.

3

## ▶ Máxima comodidad:

Su filtro de entrada de agua externo facilita su limpieza y mantenimiento. Además, son capaces de succionar agua desde cualquier depósito, sin necesidad de depender de una toma de agua corriente.

## COMPARATIVA DE HIDROLIMPIADORAS



	HL1400E	HL1700E	HL2400PROE
<b>Tipo de motor</b>	De escobillas universal	De escobillas universal	De inducción con bobinado de cobre
<b>Potencia</b>	1,4 kW	1,7 kW	2,4 kW
<b>Presión Máx.</b>	120 bar	140 bar	150 bar
<b>Caudal Máx.</b>	330 l/h	380 l/h	500 l/h
<b>Manguera de alta presión</b>	3 m (PVC)	5 m (PVC)	8 m (PVC)
<b>Cable de alimentación</b>	5 m	5 m	5 m
<b>Características especiales</b>	<ul style="list-style-type: none"> <li>Pistola con sistema No Force.</li> <li>Ruedas para transporte.</li> <li>Capacidad de succión de agua.</li> <li>Rociador de espuma ajustable con depósito de jabón.</li> </ul>	<ul style="list-style-type: none"> <li>Pistola con sistema No Force.</li> <li>Ruedas para transporte.</li> <li>Capacidad de succión de agua.</li> <li>Rociador de espuma ajustable con depósito de jabón.</li> <li>Enrollador de manguera.</li> </ul>	<ul style="list-style-type: none"> <li>Pistola metálica reforzada.</li> <li>Ruedas para transporte.</li> <li>Capacidad de succión de agua.</li> <li>Depósito integrado de detergente.</li> <li>Enrollador de manguera.</li> </ul>
<b>Peso (neto / bruto)</b>	5 / 6 kg	8 / 9,5 kg	19 / 21 kg
<b>Dimensiones generales producto</b>	397x238x651 mm	333x394x855 mm	303x384x916 mm
<b>Tipo de bomba</b>	Bomba axial	Bomba axial	Bomba axial
<b>Material de la bomba</b>	PA	Aluminio	Aluminio
<b>Tipo de pistón</b>	Acero	Acero	Acero

## ¿QUÉ QUIERES LIMPIAR?



	HL1400E	HL1700E	HL2400PROE
Herramientas de jardín	▲	▲	▲
Muebles de jardín	▲	▲	▲
Vallas	▲	▲	▲
Senderos	▲	▲	▲
Camino de jardín	▲	▲	▲
Escaleras exteriores	▲	▲	▲
Muros de piedra	▲	▲	▲
Suelos de exterior	▲	▲	▲
Piscinas	▲	▲	▲
Tejados	▲	▲	▲
Fachadas	▲	▲	▲
Bicicletas	▲	▲	▲
Motos y ciclomotores	▲	▲	▲
Vehículos medianos	▲	▲	▲
Vehículos familiares	▲	▲	▲
Furgonetas	▲	▲	▲
Autocaravanas	▲	▲	▲



# ASPIRADORA

1  
2  
3

- ▶ **Aspira todo:**  
Aspiración en seco y húmedo de sólidos y líquidos para ayudar en la limpieza más completa.
- ▶ **Versátil:**  
Enchufe sincronizado que permite conectar diferentes herramientas eléctricas de hasta 1.000W al aspirador.
- ▶ **Mayor eficiencia:**  
Función especial de soplado que ayuda a amontonar el polvo y restos a aspirar, para facilitar la limpieza de zonas amplias y conseguir una limpieza más rápida. Mayor eficiencia.

## USOS

Aspiración tanto de restos sólidos como líquidos, del taller o diferentes áreas de trabajo.



LÍQUIDOS



SÓLIDOS

## CARACTERÍSTICAS



### ASL2500E

Tipo de motor	De escobillas universal
Potencia	2 kW
Tamaño del depósito	25 l
Aspiración Máx.	16 kPa
Flujo de aire Máx.	28 ± 2 l/s
Tipo de manguera	2 m (EVA)
Cable de alimentación	5 m
Características especiales	<ul style="list-style-type: none"> <li>• Con función especial de soplado</li> <li>• Enchufe sincronizado</li> <li>• Aspiración en seco y húmedo de sólidos y líquidos</li> </ul>
Peso (neto / bruto)	4,7 / 5,2 Kg
Dimensiones generales producto	362x342x615 mm

## ACCESORIOS DE LA GAMA DE LIMPIEZA



### HL1400E / HL1700E



PISTOLA NO FORCE



LANZAS



MANGUERA DE ALTA PRESIÓN 3M / 5M



BOTE DE DETERGENTE



FILTRO DE AGUA DESMONTABLE



CONECTOR RÁPIDO MANGUERA



BOQUILLA REGULABLE



BOQUILLA TURBO



### HL2400PROE



PISTOLA METÁLICA REFORZADA



LANZA CON BOQUILLA TURBO



LANZA CON BOQUILLA AJUSTABLE (0°-60°)



MANGUERA DE ALTA PRESIÓN 8M



FILTRO DE AGUA DESMONTABLE



CONECTOR RÁPIDO MANGUERA



BOQUILLA ROCIADOR DE ESPUMA



### ASL2500E



TUBO TELESCÓPICO DE ACERO



MANGUERA FLEXIBLE



BOLSA DE TELA SIN TEJER



FILTRO DE ESPONJA



RUEDAS ORIENTABLES



CEPILLO SUCCIÓN DE AGUA



CEPILLO COMBINADO



BOQUILLA ESTRECHA DE ASPIRACIÓN

# LIMPIEZA

## HIDROLIMPIADORAS



**NEW**

► HIDROLIMPIADORA DE 120 BAR HL1400E

REF.	€	8 41 4299	g	A mm	B mm	C mm	Kw	bar	l/h	
HL1400E	110,60	032680	1	5.000	295	270	400	1,4	120	330



**NEW**

► HIDROLIMPIADORA DE 140 BAR HL1700E

REF.	€	8 41 4299	g	A mm	B mm	C mm	Kw	bar	l/h	
HL1700E	172,30	032819	1	9.000	307	307	651	1,7	140	380



**NEW**

► HIDROLIMPIADORA DE 150 BAR HL2400PROE

REF.	€	8 41 4299	g	A mm	B mm	C mm	Kw	bar	l/h	
HL2400PROE	312,30	032833	1	19.000	360	400	770	2,4	150	500

## ASPIRADORAS



**NEW**

► ASPIRADOR LÍQUIDOS Y SÓLIDOS SINCRONIZADO ASL2500SE

REF.	€	8 41 4299	g	A mm	B mm	C mm	Kw	L	kPa	
ASL2500SE	88,06	032666	1	6.700	345	345	590	2	25	16

## ACCESORIOS PARA HIDROLIMPIADORAS



► ACCESORIOS PARA HIDROLIMPIADORA HL1400E / HL1700E / HL2400PROE

REF.	€	8 41 4299	g	A mm	B mm	C mm	Kw	bar	l/h
AC59HL2400PRO	0,40	37968	1						HL2400PROE
AC61HL1400	9,32	34639	1						HL1400E
AC62HL1400	7,98	34738	1						HL1400E
AC66HL1400	19,33	35292	1						HL1400E / HL2400PROE / HL2400PROE
AC68HL1400	0,40	24807	1						HL1400E / HL1700E
AC80HL	21,31	76608	1						HL1400E / HL1700E
AC81HL	8,67	76646	1						HL1400E / HL1700E
AC82HL	8,67	76660	1						HL1400E / HL1700E
AC83HL	13,40	76707	1						HL1400E / HL1700E
AC84HL	6,84	76738	1						HL1400E / HL1700E / HL2400PROE
AC84HL1700	7,98	37111	1						HL1700E
AC85HL	2,48	76752	1						HL1400E / HL1700E / HL2400PROE
AC85HL1700	9,32	37135	1						HL1700E
AC85HL2400PRO	26,26	38279	1						HL2400PROE
AC86HL1700	25,74	37159	1						HL1700E
AC86HL2400PRO	12,47	38309	1						HL2400PROE
AC87HL2400PRO	10,96	38323	1						HL2400PROE
AC89HL2400PRO	38,42	38361	1						HL2400PROE
AC91HL2400PRO	8,24	38422	1						HL2400PROE
MSF3HL	25,82	49091	1						HL1400E / HL1700E / HL2400PROE

## ACCESORIOS PARA ASPIRADORAS



► ACCESORIOS PARA ASPIRADORA ASL2500SE

REF.	€	8 41 4299	g	A mm	B mm	C mm	Kw	L	kPa
AC16ASL2500S	6,14	38750	1						ASL2500SE
AC20ASL2500S	7,68	38774	1						ASL2500SE
AC27ASL2500S	14,29	38866	1						ASL2500SE
AC38ASL2500S	16,82	38910	1						ASL2500SE
AC43ASL2500S	21,02	38941	1						ASL2500SE
AC44ASL2500S	10,23	38965	1						ASL2500SE
AC45ASL2500S	2,52	38989	1						ASL2500SE
AC46ASL2500S	2,52	39009	1						ASL2500SE





Herramientas para  
romper muros  
y construir sueños

**PARA  
LA CONSTRUCCIÓN**

# PALAS CONSTRUCCIÓN

## PALAS

- Fabricadas con Acero Especial Bellota.
- Tratamiento térmico 3+ para alargar la vida útil de la herramienta: no se rompe, no se deforma, no se desgasta.
- Cubo muy resistente, remachado, que asegura una perfecta unión hoja mango.
- Mangos de madera de haya barnizados, ligeros y de tacto agradable. Certificados PEFC. Tres posibilidades de mango muleta (M), anilla (A) y largo (L).
- Pintura epoxi para evitar la oxidación de la herramienta.

### Usos:

- Para cavar y recoger escombros, cemento, tierra, etc

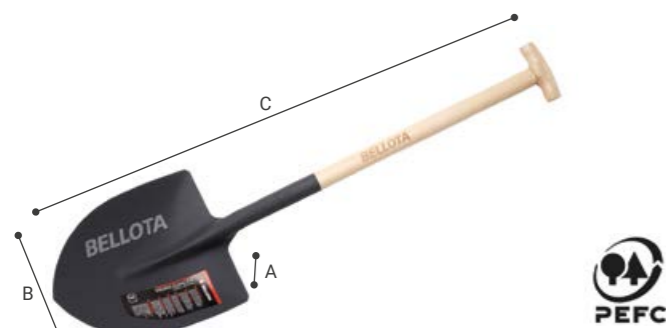

► PALA PUNTA MANGO MULETA 5501

REF.	€	8 41 4299	g	A mm	B mm	C mm	M
5501-2 M	23,60	500103	6	1.800	140	265	1.015 M5501M M5501A M5501L M5501MSB
5501-3 M	24,36	500400	6	1.900	150	285	1.020 M5501M M5501A M5501L M5501MSB
5501-4 M	27,93	500608	6	2.180	155	295	1.025 M5501M M5501A M5501L M5501MSB



► PALA PUNTA MANGO ANILLA 5501

REF.	€	8 41 4299	g	A mm	B mm	C mm	M
5501-2 A	26,83	500202	6	1.800	140	265	1.015 M5501M M5501A M5501L M5501MSB
5501-3 A	27,59	500509	6	1.960	150	285	1.025 M5501M M5501A M5501L M5501MSB
5501-4 A	33,00	500707	6	2.190	155	295	1.030 M5501M M5501A M5501L M5501MSB



► PALA PUNTA MANGO LARGO 5501

REF.	€	8 41 4299	g	A mm	B mm	C mm	M
5501-2 L	31,61	500301	6	2.290	140	265	1.480 M5501M M5501A M5501L M5501MSB



► PALA CUADRADA MANGO MULETA 5502

REF.	€	8 41 4299	g	A mm	B mm	C mm	M
5502-2 M	24,61	501100	6	1.900	150	255	1.005 M5501M M5501A M5501L M5501MSB
5502-3 M	25,01	501308	6	2.000	160	265	1.020 M5501M M5501A M5501L M5501MSB
5502-4 M	27,93	501506	6	2.240	170	275	1.030 M5501M M5501A M5501L M5501MSB
5502-6 M	30,19	501704	6	2.660	190	305	1.050 M5501M M5501A M5501L M5501MSB



► PALA CUADRADA MANGO ANILLA 5502

REF.	€	8 41 4299	g	A mm	B mm	C mm	M
5502-2 A	27,90	501209	6	2.190	150	255	1.010 M5501M M5501A M5501L M5501MSB
5502-3 A	28,71	501407	6	2.120	160	265	1.030 M5501M M5501A M5501L M5501MSB
5502-4 A	33,00	501605	6	2.420	170	275	1.035 M5501M M5501A M5501L M5501MSB
5502-6 A	35,36	501803	6	2.750	190	305	1.062 M5501M M5501A M5501L M5501MSB



► PALA CUADRADA MANGO LARGO 5502

REF.	€	8 41 4299	g	A mm	B mm	C mm	M
5502-2 L	31,61	501254	6	2.280	150	255	1.470 M5501M M5501A M5501L M5501MSB



► PALA PUNTA MANGO LARGO 5505L

REF.	€	8 41 4299	g	A mm	B mm	C mm	
5505L	27,75	710328	6	2.290	140	265	1.480



► PALA PUNTA 5550

REF.	€	8 41 4299	g	A mm	B mm	C mm	M
5550-27 SM	14,60	606829	6	940	125	270	400 M55562CSB M55562RSB
5550-29 SM	16,51	537536	130	1.050	140	295	415 M55562CSB M55562RSB
5550-31 SM	16,72	526547	120	1.300	160	310	456 M55562CSB M55562RSB



► PALA PUNTA MANGO RECTO SIN BARNIZAR 5550

REF.	€	8 41 4299	g	A mm	B mm	C mm	M
5550-27 MRSB	30,13	671384	2	2.100	125	270	1.420 M55562RSB
5550-27 MLSB	30,74	675290	2	1.950	125	270	1.550 M55562RSB



► PALA PUNTA 5551

REF.	€	8 41 4299	g	A mm	B mm	C mm	M
5551 SPUL	12,31	501810	20	890	95	294	373 M55562CSB M55562RSB



► PALA PUNTA 5552

REF.	€	8 41 4299	g	A mm	B mm	C mm	M
5552-26 SM	13,52	501544	25 620	60	265	340	M55562CSB M55562RSB



► PALA REDONDA 5556

REF.	€	8 41 4299	g	A mm	B mm	C mm	M
5556-2 SM	13,30	779790	25 890	50	264	360	M55562CSB M55562RSB



► PALA REDONDA MANGO RECTO SIN BARNIZAR 5556

REF.	€	8 41 4299	g	A mm	B mm	C mm	M
5556-2 MRSB	29,47	675276	2 2.000	60	265	1.480	M55562RSB



► PALA PUNTA 5557

REF.	€	8 41 4299	g	A mm	B mm	C mm	M
5557-23 SM	12,84	598926	25 950	43	218	375	M55562CSB M55562RSB

## RASCADOR

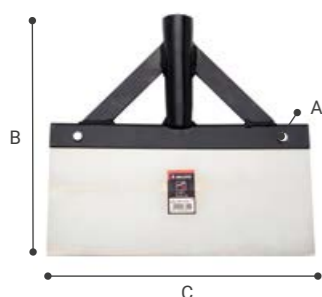

► RASCADOR REFORZADO 5710

REF.	€	8 41 4299	g	A mm	B mm	C mm	M
5710	20,96	638950	6 1.040	35	304	291	M5701L M5701L120

# HERRAMIENTAS DESENCOFRADO

- Fabricadas con Acero Especial Bellota.
- Tratamiento térmico 3+ para alargar la vida útil de la herramienta: no se rompe, no se deforma, no se desgasta.
- Cabezas y uñas forjadas para una mayor resistencia de la herramienta.
- Diseño especial de las uñas para realizar el mínimo esfuerzo.
- Pintura al agua para evitar la oxidación de la herramienta.

### Usos:

- Desencofradores: para realizar palanca y eliminar el soporte del encofrado.
- Grifas: para doblar ferralla en el proceso de encofrado.

## DESENCOFRADORES

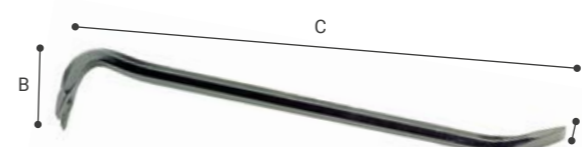

► DESENCOFRADOR 5982

REF.	€	8 41 4299	g	A mm	B mm	C mm
5982-18x500	19,68	157000	6 1.120	30	95	500
5982-20x600	22,53	156997	6 1.710	40	105	605
5982-20x700	25,24	156980	6 2.080	48	120	706
5982-22x800	30,10	156973	6 2.790	50	130	800
5982-22x1000	37,20	156966	6 3.330	50	130	1.000
5982-22x1200	40,44	433098	4 4.100	50	135	1.200



► BARRA PEQUEÑA PARA SACAR CLAVOS 5981

REF.	€	8 41 4299	g	A mm	B mm	C mm
59818	15,18	705430	6 200	12	65	200
598110	16,27	705454	6 300	12	70	250
598112	17,36	705478	6 350	15	75	300

## GRIFAS

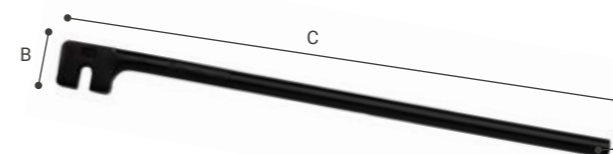

► GRIFA 5985

REF.	€	8 41 4299	g	A mm	B mm	C mm
5985-8	18,17	157901	6 450	12	31	390
5985-10	20,06	157079	6 820	15	37	456
5985-12	22,88	157062	6 870	15	38	495
5985-14	27,64	157055	6 1.810	20	50	595
5985-16	34,72	157048	10 2.090	20	50	700
5985-18	41,40	157031	6 2.500	20	50	855
5985-20	52,07	157024	6 2.880	20	50	997
5985-22	67,56	157017	4 5.040	25	62	1.094

# RAEDERAS Y RASTRILLOS

- Fabricados con Acero Especial Bellota.
- Forjados en una sola pieza, irrompibles.
- Tratamiento térmico 3+ para alargar la vida útil de la herramienta: no se rompe, no se deforma, no se desgasta.
- Pintura epoxi para evitar la oxidación de la herramienta.

## Usos:

- Raederas y Rastrillos: para mover y esparcir masa de cemento, hormigón, arena y piedra

## RAEDERAS

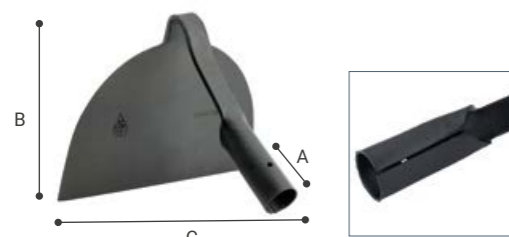

▶ RAEDERA HOMBROS CURVOS 5701

REF.	€	8 41 4299	g	A mm	B mm	C mm
5701-0	36,12	126402	6	1.190	185	258
5701-B	43,09	126600	6	1.290	190	300



▶ RAEDERA HOMBROS CURVOS 5702

REF.	€	8 41 4299	g	A mm	B mm	C mm	M
SCR5702AP	26,86	704990	6	1.310	65	264	230



▶ RAEDERA HOMBROS RECTOS 5709

REF.	€	8 41 4299	g	A mm	B mm	C mm
5709	48,88	127003	6	1.146	135	305

## RASTRILLOS

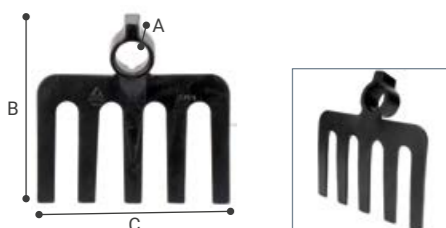

▶ RASTRILLO 5 PÚAS PLANAS PRK5751P

REF.	€	8 41 4299	g	A mm	B mm	C mm	M
PRK5751P	35,25	699388	6	1.520	40	235	225

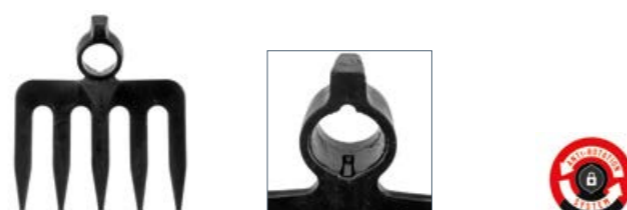

▶ RASTRILLO 5 PUNTAS PRK5753P

REF.	€	8 41 4299	g	A mm	B mm	C mm	M
PRK5753BP	31,59	696653	6	1.320	45	200	230



▶ RASTRILLO 6 PÚAS PRK5754P

REF.	€	8 41 4299	g	A mm	B mm	C mm	M
PRK5754P	36,57	699364	6	1.430	35	220	230

# TENAZAS

- Fabricadas con Acero Especial Bellota.
- Forjadas en una sola pieza, irrompibles.
- Tratamiento térmico 3+ para alargar la vida útil de la herramienta: no se rompe, no se deforma, no se desgasta. Filos templados por inducción a gran profundidad.
- Filos perfectamente alineados para garantizar un corte preciso.
- Pintura epoxi para evitar la oxidación de la herramienta.

## Usos:

- Para labores de encofrado, carpintería y alicatado

## TENAZA RUSA

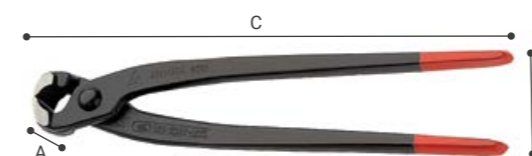

▶ TENAZA RUSA 6001

REF.	€	8 41 4299	g	A mm	B mm	C mm
6001-225	16,56	157604	6	310	22	45
6001-250	17,84	157611	6	390	25	50
6001-280	21,30	157628	6	420	25	50
6001-300	22,28	949711	6	530	25	57

## TENAZA CARPINTERO



▶ TENAZA CARPINTERO 6005

REF.	€	8 41 4299	g	A mm	B mm	C mm
6005-180	18,37	157635	6	300	21	50
6005-200	19,23	157642	6	380	25	53
6005-225	21,90	157659	6	410	25	55
6005-250	26,39	157666	6	540	27	57

## TENAZA ALICATADO



▶ TENAZA ALICATADO 6003

REF.	€	8 41 4299	g	A mm	B mm	C mm
6003	18,17	628982	6	360	57	25

Especial cerámica ajustes de cortes rectos.



▶ TENAZA ALICATADO 6004

REF.	€	8 41 4299	g	A mm	B mm	C mm
6004	18,17	629002	6	240	55	13

Especial cerámica ajustes de cortes rectos.

# CORTAVARILLAS

- Cabezas forjadas en una sola pieza, irrompibles.
- Tratamiento térmico 3+ para alargar la vida útil de la herramienta: no se rompe, no se deforma, no se desgasta. Filos templados por inducción a gran profundidad.
- Sistema de ajuste de cuchillas mediante tornillo de eje descentrado para asegurar una perfecta alineación de los filos.
- Empuñaduras en elastómero para evitar el deslizamiento de la mano durante el corte.
- Pintura epoxi para evitar la oxidación de la herramienta.

## Usos:

- Para corte de varillas de acero

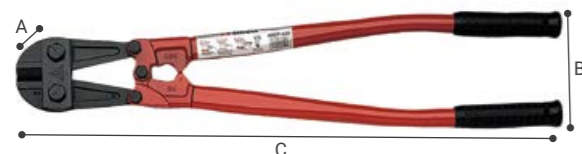

▶ CORTAVARILLAS 6009

REF.	€	8 41 4299	g	A mm	B mm	C mm
6009-450	97,33	159011	1	1.550	35	125
6009-600	110,69	159028	1	2.600	40	146
6009-750	144,12	159035	1	4.010	45	150
6009-900	183,29	159042	1	6.110	50	160
6009-1050	238,38	159059	1	8.940	55	202



▶ MINICORTAVARILLAS 26009

REF.	€	8 41 4299	g	A mm	B mm	C mm
26009-300	20,31	699630	1	700	310	52
26009-350	25,40	699654	1	810	365	60

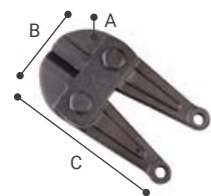

▶ CABEZA CORTAVARILLAS 6009

REF.	€	8 41 4299	g	A mm	B mm	C mm
C 6009-450	55,22	158960	3	1.000	35	70
C 6009-600	75,52	158977	3	2.510	40	85
C 6009-750	89,53	158984	1	1.430	45	95
C 6009-900	106,60	158991	1	2.080	50	110
C 6009-1050	138,86	159004	1	2.910	60	122



▶ TORNILLO MANGO CORTAVARILLAS 6009

REF.	€	8 41 4299	g	A mm	B mm	C mm
T 6009-450 M	5,33	179569	100	10	11	21
T 6009-600 M	5,33	179576	100	30	13	30
T 6009-750 M	5,33	179606	100	30	15	40
T 6009-900 M	5,33	179620	100	60	12	43
T 6009-1050 M	5,33	179637	100	80	20	45
T 6009-450 C	5,33	179477	1	40	17	36
T 6009-600 C	5,33	179484	1	60	19	40
T 6009-750 C	5,33	179514	1	90	21	45
T 6009-900 C	5,33	179521	100	130	25	50
T 6009-1050 C	5,33	179538	100	190	28	57

M: Mango  
C: Cabeza

## LONGITUD

MATERIAL A CORTAR	450 mm 19"	600 mm 24"	750 mm 30"	900 mm 36"	1.050 mm 24"
Varilla blanda 50 kgs/mm <sup>2</sup>	Ø 8 mm	Ø10 mm	Ø 13 mm	Ø 16 mm	Ø 19 mm
Varilla dura 133 kgs/mm <sup>2</sup> HRC-41	Ø 6 mm	Ø 8 mm	Ø 9 mm	Ø 10 mm	Ø 11 mm
Varilla extradura 50 kgs/mm <sup>2</sup> HRC-48	Ø 5,5 mm	Ø 7 mm	Ø 8 mm	Ø 9 mm	Ø 10 mm

# ORDENACIÓN

## PORTA HERRAMIENTAS

- Porta herramientas de alta calidad con remaches cerrados y costuras reforzadas, gran duración y resistencia.
- Ajustables a cualquier cintura y con capacidad para lo que precisas.
- Dos tipos:
  - Piel serraje de alta calidad
  - Poliéster técnico de alta calidad

## Usos:

- Para trabajadores de la construcción, instaladores y especialmente encofradores y plaquistas.

## BOLSAS Y MOCHILAS

- Fabricadas en poliéster técnico de alta calidad con costuras reforzadas, gran duración y resistencia.
- Con divisores y compartimentos para lo que precisas.

## Usos:

- Para trabajadores de la construcción, industria, servicios técnicos, instaladores...

## PORTA HERRAMIENTAS DE PIEL



▶ PORTA MARTILLOS DE PIEL PCMAR

REF.	€	8 41 4299	g	A mm	B mm	C mm
PCMAR	4,35	715224	1	130	70	135



▶ CINTURÓN PORTA-HERRAMIENTAS DE PIEL CON 3 BOLSILLOS PC3BOL

REF.	€	8 41 4299	g	A mm	B mm	C mm
PC3BOL	7,61	715309	1	318	70	225



▶ CINTURÓN PORTA-HERRAMIENTAS DE PIEL CON 6 BOLSILLOS PC6BOL

REF.	€	8 41 4299	g	A mm	B mm	C mm
PC6BOL	18,64	715323	1	545	70	550



▶ BOLSA PORTA-HERRAMIENTAS DE PIEL CON 4 BOLSILLOS PC4BOL

REF.	€	8 41 4299	g	A mm	B mm	C mm
PC4BOL	9,88	715347	1	345	80	320



▶ CANANA ENCOFRADOR 51308

REF.	€	8 41 4299	g	A mm	B mm	C mm
51308	42,66	162271	2	683	50	575

Fabricada en cuero remachado. Gran duración y resistencia. Cuatro bolsillos y alojamiento para martillos.



▶ CANANA INSTALADOR DE PLACA 51320

REF.	€	8 41 4299	g	A mm	B mm	C mm
51320	47,97	561678	3	753	40	1.300

Fabricado en cuero de alta calidad y con remachado de alta resistencia. Cinturón de nylon con agujeros reforzados y hebilla metálica. 5 bolsillos para alojar diferentes tipos de tornillo y remaches. Alojamiento especial reforzado para tijera.

## PORTA HERRAMIENTAS TEXTILES



► PORTA HERRAMIENTAS PNTOOL

REF.	€	8 41 4299	g	A mm	B mm	C mm
PNTOOL	4,59	011722	1	200	40	230 165



► PORTA FLEXÓMETROS PNFLEX

REF.	€	8 41 4299	g	A mm	B mm	C mm
PNFLEX	3,29	715446	1	66	55	120 160



► PORTA CUTTERS PNCUT

REF.	€	8 41 4299	g	A mm	B mm	C mm
PNCUT	3,24	715248	1	78	20	135 190



► PORTA TALADROS PNTALAD

REF.	€	8 41 4299	g	A mm	B mm	C mm
PNTALAD	16,75	715361	1	265	90	165 345



► CINTURÓN PNCIN

REF.	€	8 41 4299	g	A mm	B mm	C mm
PNCIN	3,40	715385	1	115	15	140 60



► CINTURÓN PORTA-HERRAMIENTAS CON 4 BOLSILLOS PN4BOL

REF.	€	8 41 4299	g	A mm	B mm	C mm
PN4BOL	7,61	715262	1	332	80	235 280



► CINTURÓN PORTA-HERRAMIENTAS CON 7 BOLSILLOS PN7BOL

REF.	€	8 41 4299	g	A mm	B mm	C mm
PN7BOL	14,94	715286	1	545	80	600 250

## BOLSAS, MOCHILAS Y TROLLEYS



► BOLSA PORTA-HERRAMIENTAS BN

REF.	€	8 41 4299	g	A mm	B mm	C mm
BN35	8,37	715408	1	765	230	310 260
BN45	12,92	715422	1	970	230	430 265



► BOLSA ABIERTA 30 CM BN30A

REF.	€	8 41 4299	g	A mm	B mm	C mm
BN30A	52,79	011760	4	1.360	200	320 260



► BOLSA TAPA PLANA 45 CM BN45P

REF.	€	8 41 4299	g	A mm	B mm	C mm
BN45P	58,00	011807	4	1.630	250	440 260



► MOCHILA CON RUEDAS 35 L MN35R

REF.	€	8 41 4299	g	A mm	B mm	C mm
MN35R	75,45	011845	6	2.400	250	360 540



► MOCHILA 20 L MN20

REF.	€	8 41 4299	g	A mm	B mm	C mm
MN20	71,10	011883	6	1.670	185	305 475



► TROLLEY CON RUEDAS 32 L TR32

REF.	€	8 41 4299	g	A mm	B mm	C mm
TR32	119,97	011920	2	4.910	250	430 380

## CAJAS PORTA HERRAMIENTAS



► CAJA PORTA-HERRAMIENTAS METÁLICA 6900

REF.	€	8 41 4299	g	A mm	B mm	C mm
6900-400	45,12	057133	1	3.240	200	415 230
6900-500	48,97	057140	1	3.680	200	510 230



► CAJA PORTA-HERRAMIENTAS METÁLICA 6902

REF.	€	8 41 4299	g	A mm	B mm	C mm
6902-500	86,26	057157	1	4.740	200	505 280

# PALETAS

**Hoja cónica:**  
Espesores adaptados para la perfecta flexión de la hoja

Ref. 5842-H BIM



600 Kg. de resistencia

**Irrompible:**  
Forjada en una sola pieza

## PALETAS

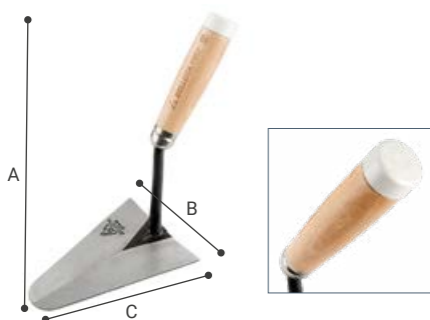

► PALETA MANGO MADERA CON TACO TRF41BPB

REF.	€	8 41 4299	g	A mm	B mm	C mm	L mm
TRF41BPB	23,35	690590	6	420	250	120	320 165



► PALETA MANGO MADERA CON TACO TRF42HPB

REF.	€	8 41 4299	g	A mm	B mm	C mm	L mm
TRF42HPB	21,75	690613	6	320	110	103	318 190



► PALETA 5841

REF.	€	8 41 4299	g	A mm	B mm	C mm	L mm
5841-A	23,62	131208	6	400	235	115	310 150
5841-B	22,88	131307	6	410	235	120	320 165
5841-C	23,21	131406	6	460	235	125	325 180

Paleta Catalana.



► PALETA MANGO BIMATERIAL TRF41BM

REF.	€	8 41 4299	g	A mm	B mm	C mm	L mm
TRF41ABM	25,17	695748	6	400	240	114	325 150
TRF41BBM	25,05	695809	6	455	240	119	330 165
TRF41CBM	25,64	695786	6	470	240	123	340 180



► PALETA 5842

REF.	€	8 41 4299	g	A mm	B mm	C mm	L mm
5842-B	19,00	131604	6	170	90	67	235 115
5842-D	19,99	131802	6	210	100	80	255 140
5842-F	19,88	132007	6	210	100	91	280 165
5842-H	21,17	132205	6	320	105	103	318 190
5842-J	22,93	132403	6	340	105	115	342 215
5842-K	23,92	155228	6	380	105	121	350 227
5842-L	24,20	132601	6	400	105	127	365 240

Paleta Madrileña.



► PALETA MANGO BIMATERIAL TRF42BM

REF.	€	8 41 4299	g	A mm	B mm	C mm	L mm
TRF42FBM	22,30	695823	6	280	110	91	295 165
TRF42HBM	23,53	695847	6	330	115	102	330 190
TRF42JBM	25,17	695861	6	360	115	115	345 215
TRF42KBM	25,77	695885	6	380	115	120	360 227
TRF42LBM	26,11	695908	6	380	115	127	380 240



► PALETA 5843

REF.	€	8 41 4299	g	A mm	B mm	C mm	L mm
5843-A	25,92	132700	6	400	100	110	310 180
5843-C	26,78	132908	6	420	100	118	330 200

Paleta Andaluza.



► PALETA MANGO BIMATERIAL TRF43BM

REF.	€	8 41 4299	g	A mm	B mm	C mm	L mm
TRF43ABM	27,47	699883	6	430	110	110	320 180
TRF43CBM	27,57	699906	6	430	115	118	340 200



► PALETA 5844

REF.	€	8 41 4299	g	A mm	B mm	C mm	L mm
5844-A	25,44	133004	6	430	160	115	320 180
5844-B	25,44	133103	6	480	160	130	320 180
5844-C	26,65	133202	6	460	170	117	325 190

Paleta Norte.



► PALETA MANGO BIMATERIAL TRF44BM

REF.	€	8 41 4299	g	A mm	B mm	C mm	L mm
TRF44ABM	27,06	695922	6	470	175	115	292 180
TRF44BBM	27,06	695946	6	510	175	130	292 180
TRF44CBM	27,65	695960	6	520	180	117	340 190



► PALETA MANGO MADERA CON TACO TRF44APB

REF.	€	8 41 4299	g	A mm	B mm	C mm	L mm
TRF44APB	25,80	690637	6	450	175	115	287 180



► PALETA 5850

REF.	€	8 41 4299	g	A mm	B mm	C mm	L mm
5850-B	28,91	133370	6	360	70	110	370 240

Paleta Extremadura / Portugal.



► PALETA 5848

REF.	€	8 41 4299	g	A mm	B mm	C mm	L mm
5848	23,97	236972	6	367	175	110	278 120

Paleta punta redondeada especial alicatado. Mango ancho especial para golpeo del azulejo.



► PALETA MANGO BIMATERIAL TRF48BM

REF.	€	8 41 4299	g	A mm	B mm	C mm	L mm
TRF48BM	24,92	695984	6	400	175	110	280 120



► PALETA 5849

REF.	€	8 41 4299	g	A mm	B mm	C mm	L mm
5849	23,97	906394	6	458	180	110	280 120

Paleta punta cuadrada especial alicatado. Mango ancho especial para golpeo del azulejo.



► PALETA MANGO BIMATERIAL TRF49BM

REF.	€	8 41 4299	g	A mm	B mm	C mm	L mm
TRF49BM	24,92	696004	6	350	180	110	280 120



▶ PALETA 5851

REF.	€	8 41 4299	g	A mm	B mm	C mm	L mm
5851-B	29,54	133400	6	320	75	110	215
5851-C	29,99	133509	6	330	75	115	230
5851-D	30,54	133608	6	390	75	120	240
5851-E	30,91	133615	6	450	75	130	255

Paleta Portuguesa.



▶ PALETA 5857

REF.	€	8 41 4299	g	A mm	B mm	C mm	L mm
5857-8	20,92	160321	6	275	318	90	200
5857-85	21,11	908657	6	320	338	96	220
5857-7	20,51	136654	6	260	290	81	180
5857-95	21,37	908732	6	365	348	106	240

Paleta Grecia.



▶ PALETA MANGO BIMATERIAL TRF14BM

REF.	€	8 41 4299	g	A mm	B mm	C mm	L mm
TRF14ABM	24,54	696141	6	490	130	125	180



▶ PALETA MANGO BIMATERIAL 5919

REF.	€	8 41 4299	g	A mm	B mm	C mm	L mm
5919-14 CC BIM	22,87	624120	6	310	125	82	140
5919-16 CC BIM	22,87	624144	6	330	130	88	160
5919-18 CC BIM	22,87	624168	6	320	130	95	180

Paleta para enlucir. Modelo Belga "Cuello de cisne".



▶ PALETA MANGO BIMATERIAL 5904

REF.	€	8 41 4299	g	A mm	B mm	C mm	L mm
5904-14 CC BIM	18,79	624069	6	180	94,9	50	140
5904-16 CC BIM	19,09	624083	6	170	95	50	160
5904-18 CC BIM	20,31	624106	6	190	95	50	180

Paleta Lengua de gato "Cuello de cisne".



▶ PALETA MANGO BIMATERIAL TRF51BM

REF.	€	8 41 4299	g	A mm	B mm	C mm	L mm
TRF51BBM	30,29	696028	6	330	85	110	215
TRF51CBM	30,62	696042	6	410	85	115	230
TRF51DBM	31,41	696066	6	380	85	120	240
TRF51EBM	31,58	696080	6	420	85	130	255



▶ PALETA MANGO BIMATERIAL TRF57BM

REF.	€	8 41 4299	g	A mm	B mm	C mm	L mm
TRF57ABM	23,26	696103	6	275	95	90	200
TRF57BBM	23,47	696127	6	320	95	96	220



▶ PALETA MANGO BIMATERIAL 5915

REF.	€	8 41 4299	g	A mm	B mm	C mm	L mm
5915-17 CC BIM	24,08	624021	6	420	130	120	170

Paleta Alicatador Bruselas "Cuello de cisne".



▶ PALETA MANGO BIMATERIAL TRF21BM

REF.	€	8 41 4299	g	A mm	B mm	C mm	L mm
TRF21BBM	23,63	696301	6	480	130	125	180

## PALETINES



▶ PALETÍN 5901

REF.	€	8 41 4299	g	A mm	B mm	C mm	L mm
5901-A	20,61	134902	6	170	95	70	125
5901-B	23,54	135008	6	170	95	100	150

Para trabajos de acabado y retoques en albañilería.



▶ PALETÍN 5902

REF.	€	8 41 4299	g	A mm	B mm	C mm	L mm
5902	19,99	135107	6	183	93	60	135

Para trabajos de acabado y retoques en albañilería.



▶ PALETÍN 5903

REF.	€	8 41 4299	g	A mm	B mm	C mm	L mm
5903	20,61	135206	6	203	90	75	125

Para trabajos de acabado y retoques en albañilería.



▶ PALETÍN MANGO BIMATERIAL TRF01BM

REF.	€	8 41 4299	g	A mm	B mm	C mm	L mm
TRF01BM	20,66	696387	6	170	95	70	125

Para trabajos de acabado y retoques en albañilería.



▶ PALETÍN MANGO BIMATERIAL TRF02BM

REF.	€	8 41 4299	g	A mm	B mm	C mm	L mm
TRF02BM	21,73	696400	6	180	95	60	135

Para trabajos de acabado y retoques en albañilería.



▶ PALETÍN MANGO BIMATERIAL TRF03BM

REF.	€	8 41 4299	g	A mm	B mm	C mm	L mm
TRF03BM	21,73	696424	6	180	90	76	125

Para trabajos de acabado y retoques en albañilería.

## REJUNTEADOR



▶ REJUNTEADOR FORJADO MANGO BIMATERIAL 5913

REF.	€	8 41 4299	g	A mm	B mm	C mm	L mm
5913-06 BIM	9,14	623680	6	110	95	6	288
5913-08 BIM	9,23	623703	6	120	90	8	290
5913-10 BIM	9,69	623727	6	120	90	10	289
5913-12 BIM	10,17	623741	6	170	100	12	315

\* DISPONIBILIDAD HASTA FIN DE EXISTENCIAS



▶ REJUNTEADOR 5897

REF.	€	8 41 4299	g	A mm	B mm	C mm	L mm
5897-6	7,21	134285	6	100	90	30	299
5897-8	7,29	134889	6	110	95	30	300
5897-10	7,66	134957	6	100	85	30	302
5897-12	7,86	124989	6	140	90	30	310



# LLANAS, TALOCHAS Y ESPÁTULAS

## LLANAS

- Fabricadas en Acero Flexible Especial Bellota.
- Tratamiento térmico 3+ para alargar la vida útil de la herramienta: no se rompe, no se deforma, no se desgasta.
- Mango muy ergonómico y ligero: hueco de la mano adaptado a usos y necesidades. Válido para diestros y zurdos.
- Dos tipos de mango:
  - Mangos de madera de chopo barnizados, extra-ligeros y de tacto agradable.
  - Mangos bimateriales ergonómicos con acabado SOFT TOUCH para mayor comodidad durante el trabajo.
- Perfecto enmangado y planitud de la hoja.
- Hojas barnizadas en epoxi para evitar la oxidación de la herramienta.

### Usos:

- Para realizar trabajos de acabado.
- Para extender y alisar cemento, mortero, yeso y otros materiales.

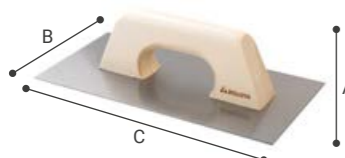

▶ LLANA RECTA 5861

REF.	€	8 41 4299	g	A mm	B mm	C mm	
5861-00	12,00	133707	6	370	75	135	270
5861-0	12,00	133806	6	360	75	120	300
5861-1	12,25	133905	6	510	75	150	300
5861-2	12,42	134001	6	430	75	160	300
5861-3	13,06	134100	6	460	75	180	300



▶ LLANA RECTA MANGO BIMATERIAL 5861

REF.	€	8 41 4299	g	A mm	B mm	C mm	
5861-00 BIM	12,53	547160	6	380	75	135	270
5861-0 BIM	12,53	547184	6	370	75	120	300
5861-1 BIM	13,06	547207	6	420	75	150	300
5861-2 BIM	14,00	547221	6	430	75	160	300
5861-3 BIM	14,19	547245	6	460	75	180	300



▶ LLANA RECTA INOXIDABLE 5861

REF.	€	8 41 4299	g	A mm	B mm	C mm	
5861-1 INOX	13,27	663037	6	410	75	150	300



▶ LLANA RECTA INOXIDABLE MANGO BIMATERIAL 5861

REF.	€	8 41 4299	g	A mm	B mm	C mm	
5861-1 BIM INOX	14,03	547269	6	410	75	150	300



▶ LLANA RECTA INOXIDABLE AFILADA 5861

REF.	€	8 41 4299	g	A mm	B mm	C mm	
5861-1 A INOX	15,80	592146	6	420	75	150	300



▶ LLANA REDONDA MANGO BIMATERIAL 5863

REF.	€	8 41 4299	g	A mm	B mm	C mm	
5863 BIM	13,42	547306	6	410	75	150	300



▶ LLANA RECTA INOXIDABLE AFILADA MANGO BIMATERIAL 5861

REF.	€	8 41 4299	g	A mm	B mm	C mm	
5861-1 A BIM INOX	17,44	592160	6	410	75	150	300



▶ LLANA RECTA MANGO ABIERTO BIMATERIAL 5864

REF.	€	8 41 4299	g	A mm	B mm	C mm	
5864 BIM	13,92	597950	6	340	85	130	280



▶ LLANA TRAPEZOIDAL 586

REF.	€	8 41 4299	g	A mm	B mm	C mm	
5862	13,68	134209	6	444	75	180	300



▶ LLANA TRAPEZOIDAL MANGO BIMATERIAL 5862

REF.	€	8 41 4299	g	A mm	B mm	C mm	
5862 BIM	15,08	547283	6	440	75	180	300



▶ LLANA REDONDA 5863

REF.	€	8 41 4299	g	A mm	B mm	C mm	
5863	12,41	134308	6	450	75	150	300



▶ LLANA LARGA 5865

REF.	€	8 41 4299	g	A mm	B mm	C mm	
5865	19,06	663075	6	806	75	150	480



▶ LLANA LARGA INOXIDABLE 5865

REF.	€	8 41 4299	g	A mm	B mm	C mm	
5865 INOX	21,24	663112	6	810	75	150	480



▶ LLANA INOXIDABLE PARA ESTUCO O MICROCEMENTO 587003

REF.	€	8 41 4299	g	A mm	B mm	C mm	
587003I	57,92	679137	6	460	87	110	360



▶ LLANA NIVELACIÓN DE ACERO CON MANGO DE MADERA 5866450

REF.	€	8 41 4299	g	A mm	B mm	C mm	
5866450	22,75	045123	6	469	450	105	90
5866500	27,75	052084	6	523	500	108	90
5866600	32,75	052916	6	607	600	113	90

NEW



▶ LLANA POLICARBONATO PARA ESTUCO O MICROCEMENTO 587020

REF.	€	8 41 4299	g	A mm	B mm	C mm	
587020P	45,05	679175	6	440	87	110	360



▶ LLANA POLIPROPILENO FLEXIBLE 5869

REF.	€	8 41 4299	g	A mm	B mm	C mm	
5869	9,87	594935	6	264	80	142	300



▶ LLANA ABS PARA CAPPOTTO 5869

REF.	€	8 41 4299	g	A mm	B mm	C mm	
5869R	5,58	679106	6	230	85	130	270



▶ RASCADOR MORTERO MONOCAPA 5880

REF.	€	8 41 4299	g	A mm	B mm	C mm	
5880	14,02	554519	6	393	85	135	247

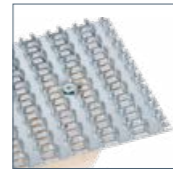

▶ RASCADOR MORTERO MONOCAPA MANGO BIMATERIAL 5880

REF.	€	8 41 4299	g	A mm	B mm	C mm	
5880 BIM	13,88	554533	6	380	80	135	250

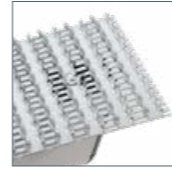

▶ HOJA RASCADOR PARA MORTERO MONOCAPA 5880H

REF.	€	8 41 4299	g	A mm	B mm	C mm	
5880H	7,08	024456	6	393	85	135	247

NEW



▶ RASCADOR YESO 5879

REF.	€	8 41 4299	g	A mm	B mm	C mm	
5879	38,18	133479	1	668	95	90	450



## REMOLINADORES

- Alta calidad de acabado. Remolinador de polietileno reticulado de gran rendimiento, hasta 1.000 m<sup>2</sup>.
- Evita que se agrieten las superficies trabajadas.
- Ligero y agarre cómodo. Los trabajos de acabado serán más fáciles con mango para proteger las manos.

### Usos:

- Evita que se agriete la superficie trabajada.
- Para trabajos de acabados, remolinado de superficies, talochado o fratasado de superficies de cemento, mortero y otros materiales.

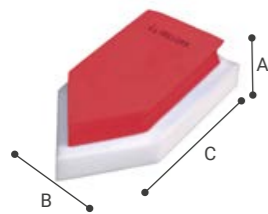

▶ REMOLINADOR PUNTA 5881PE

REF.	€	8 41 4299	g	A mm	B mm	C mm	L mm	
5881PE	11,22	714913	36	31	230	120	50	23

NEW



▶ REMOLINADOR CUADRADO 5883PE

REF.	€	8 41 4299	g	A mm	B mm	C mm	L mm	
5883PE	11,22	714937	36	36	230	120	50	23

NEW

## TALOCHAS

- Base de poliestireno de alta calidad: máxima duración sin deterioro.
- Mango de plástico muy ligero y ergonómico: hueco de la mano adaptado a usos y necesidades.
- Perfecto enmangado y planitud de la hoja.

### Usos:

- Para realizar trabajos de acabado.
- Para talochar o fratar superficies de cemento, mortero y otros materiales.

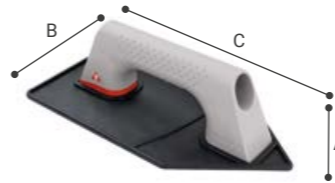

▶ TALOCHA 5881

REF.	€	8 41 4299	g	A mm	B mm	C mm	
5881	8,33	157598	12	230	75	140	270

Forma punta para acceder a rincones y esquinas. Base almenada.



▶ TALOCHA 5883

REF.	€	8 41 4299	g	A mm	B mm	C mm	
5883	8,63	157581	12	300	76	185	280

Forma rectangular. Base almenada.



▶ TALOCHA 5885

REF.	€	8 41 4299	g	A mm	B mm	C mm	
5885	10,04	157574	12	350	75	220	330

Forma rectangular. Base almenada.



▶ TALOCHA 5887

REF.	€	8 41 4299	g	A mm	B mm	C mm	
5887	10,04	157567	12	357	75	190	360

Forma rectangular. Base lisa.



▶ TALOCHA LIGERA 5882

REF.	€	8 41 4299	g	A mm	B mm	C mm	
5882	6,68	442922	12	185	90	140	265

Forma punta para acceder a rincones y esquinas. Base estriada.



▶ TALOCHA LIGERA 5884

REF.	€	8 41 4299	g	A mm	B mm	C mm	
5884	7,09	443318	12	193	95	140	265

Forma rectangular. Base estriada.



▶ TALOCHA CON ESPONJA 5889

REF.	€	8 41 4299	g	A mm	B mm	C mm	
5889	11,49	445732	6	439	95	160	280

Esponja de celdas grandes. Especial talochado.

## PEINES

- Fabricadas en acero Flexible Especial Bellota.
- Tratamiento térmico 3+ para alargar la vida útil de la herramienta: no se rompe, no se deforma, no se desgasta.
- Mango muy ergonómico: hueco de la mano adaptado a usos y necesidades.
- Dos tipos de mango:
  - Mangos de madera de chopo barnizados, EXTRA-ligeros y detacto agradable.
  - Mangos bimotores ergonómicos con acabado SOFT TOUCH para mayor comodidad durante el trabajo.
- Perfecto emangado en epoxi para evitar la oxidación de la Herramienta.

### Usos:

- Para preparar superficies para alicatar.
- Para extender cemento cola y repartirlo uniformemente para colocar el arial cerámico.



► PEINE DIENTE TRIANGULAR 5871

REF.	€	8 41 4299	g	A mm	B mm	C mm
5871-00	13,03	134704	6	360	135	80



► PEINE DIENTE TRIANGULAR MANGO BIMATERIAL 25871

REF.	€	8 41 4299	g	A mm	B mm	C mm
5871-00 BIM	13,34	547344	6	360	135	80



► PEINE DIENTE CASTILLO 5873

REF.	€	8 41 4299	g	A mm	B mm	C mm
5873-03	12,79	663198	6	340	135	80
5873-06	12,39	134803	6	360	135	80
5873-08	12,39	663235	6	340	135	80
5873-10	12,39	663273	6	340	135	80
5873-12	12,79	663358	6	370	135	80
5873-15	12,79	708554	6	360	135	80
5873-20	12,79	708578	6	360	135	80



► PEINE DIENTE CASTILLO MANGO BIMATERIAL 5873

REF.	€	8 41 4299	g	A mm	B mm	C mm
5873-03 BIM	13,57	547320	6	360	135	80
5873-06 BIM	13,57	547368	6	360	135	80
5873-08 BIM	13,57	547382	6	350	135	80
5873-10 BIM	13,57	547405	6	360	135	80
5873-12 BIM	13,57	547443	6	350	135	80
5873-15 BIM	13,57	015676	6	360	135	80
5873-20 BIM	13,57	015720	6	360	135	80



► PEINE DIENTE RADIO 5873

REF.	€	8 41 4299	g	A mm	B mm	C mm
5873-10R	12,79	663310	6	360	135	80



► PEINE DIENTE RADIO MANGO BIMATERIAL 5873

REF.	€	8 41 4299	g	A mm	B mm	C mm
5873-10R BIM	13,57	547429	6	350	140	80



► PEINE DIENTE CASTILLO MANGO ABIERTO BIMATERIAL INOX 5874

REF.	€	8 41 4299	g	A mm	B mm	C mm
5874-06 BIM INOX	15,20	624526	6	330	130	87
5874-08 BIM INOX	15,20	624540	6	330	130	87
5874-10 BIM INOX	15,20	624564	6	330	130	87
5874-12 BIM INOX	15,20	687002	6	330	130	87



► PEINE DIENTE RADIO MANGO ABIERTO BIMATERIAL INOX 5874

REF.	€	8 41 4299	g	A mm	B mm	C mm
5874-15 R BIM INOX	15,20	678499	6	330	80	130
5874-10 R BIM INOX	15,20	624588	6	330	80	130



► PEINE DIENTE CASTILLO MANGO BIMATERIAL 25874

REF.	€	8 41 4299	g	A mm	B mm	C mm
25874-06	5,95	636567	6	290	130	270
25874-10	5,95	636581	6	290	130	270



► PEINE LARGO DIENTE CASTILLO 5875

REF.	€	8 41 4299	g	A mm	B mm	C mm
5875-10	17,65	663396	6	790	135	80
5875-20	17,65	686944	6	650	135	80



► PEINE LARGO DIENTE RADIO 5875R

REF.	€	8 41 4299	g	A mm	B mm	C mm
5875-10R	17,65	663433	6	760	135	80

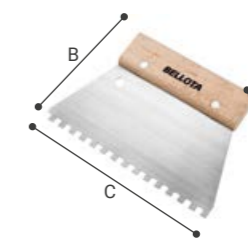

► ESPÁTULA-PEINE DIENTE CASTILLO 5877

REF.	€	8 41 4299	g	A mm	B mm	C mm
5877-03	5,26	134605	12	120	125	16
5877-06	5,26	134780	12	120	130	16
5877-08	5,26	134865	12	110	125	16



## LLANAS DE GOMA



► LLANA GOMA BLANDA 5898 A

REF.	€	8 41 4299	g	A mm	B mm	C mm
5898 A	12,86	445855	6	220	110	80

Goma fabricada en material EVA muy flexible y adaptable a todo tipo de superficies.



► LLANA GOMA MIXTA 5898 B

REF.	€	8 41 4299	g	A mm	B mm	C mm
5898 B	16,03	445985	6	300	110	80

Esponja de poliuretano muy flexible y adaptable a todo tipo de superficies, recubierta por una lámina de caucho muy resistente a la abrasión.



► LLANA GOMA DURA 5898 C

REF.	€	8 41 4299	g	A mm	B mm	C mm
5898 C	14,73	446388	6	500	110	80

Goma fabricada en caucho altamente resistente a la abrasión. Ideal para juntas de mayor anchura.

## ESPÁTULAS DE GOMA

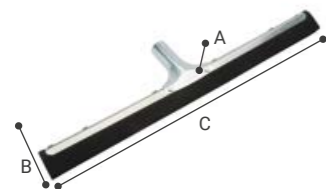

▶ **ESPÁTULA DE SUELO 5886F**

REF.	€	8 41 4299	g	A mm	B mm	C mm
5886F-45	4,85	629064	12	240	35	450
5886F-60	6,61	629088	12	310	35	600
5886F-75	8,88	699920	12	370	750	35

Banda de EVA muy flexible. Para realizar trabajos de alicatado, extender y retirar materiales utilizados en el rejunteo



▶ **ESPÁTULA DE MANO 5886W**

REF.	€	8 41 4299	g	A mm	B mm	C mm
5886W-20	4,21	629286	12	120	20	200
5886W-30	5,81	629040	12	190	20	300

Goma de caucho de alta calidad. Para realizar trabajos de alicatado, extender y retirar materiales utilizados en el rejunteo.

## TALOCHAS DE LIMPIEZA



▶ **TALOCHA 5888PE**

REF.	€	8 41 4299	g	A mm	B mm	C mm
5888PE	8,49	681970	6	280	280	140



▶ **TALOCHA 5888**

REF.	€	8 41 4299	g	A mm	B mm	C mm
5888	9,99	135138	6	280	160	100

Esponja con cortes reticulares para una mejor y fácil limpieza.



▶ **TALOCHA INTERCAMBIABLE SIMPLE 5810S**

REF.	€	8 41 4299	g	A mm	B mm	C mm
5810-S	9,17	639254	6	320	130	100

Capacidad de absorción y resistencia media.



▶ **TALOCHA INTERCAMBIABLE CLOUD 5810CL**

REF.	€	8 41 4299	g	A mm	B mm	C mm
5810-CL	11,25	639278	6	340	135	100

Capacidad de absorción y resistencia alta. Humedad duradera, mayor facilidad de trabajo.



▶ **MANGO TALOCHA INTERCAMBIABLE 5810**

REF.	€	8 41 4299	g	A mm	B mm	C mm
5810	4,92	639292	6	170	100	75



▶ **RECAMBIO TALOCHA SIMPLE 5810BS**

REF.	€	8 41 4299	g	A mm	B mm	C mm
5810B-S	6,05	639315	6	150	130	40

Capacidad de absorción y resistencia media.



▶ **RECAMBIO TALOCHA CLOUD 5810BCL**

REF.	€	8 41 4299	g	A mm	B mm	C mm
5810B-CL	8,03	639339	6	170	135	30

Capacidad de absorción y resistencia alta. Humedad duradera, mayor facilidad de trabajo.



▶ **TALOCHA EPOXI FLTSP24P**

REF.	€	8 41 4299	g	A mm	B mm	C mm
FLTSP24P	16,46	684186	12	295	250	120



▶ **RECAMBIO TALOCHA DURA SP24**

REF.	€	8 41 4299	g	A mm	B mm	C mm
SP24SP	7,13	684353	12	125	250	120
SP24MP	7,13	684377	12	150	250	120
SP24HP	7,13	684414	12	200	250	120
SP24XP	7,13	684469	12	155	250	120

Blanco: Suave  
Rojo: Medio  
Azul: Duro  
Tricolor: Mixta

## ESPÁTULAS

- Fabricadas en acero Especial Bellota máxima duración sin deterioro.
- Hojas cónicas rectificadas, alineadas y pulidas para conseguir un acabado perfecto.
- Excelente flexibilidad y comodidad durante el trabajo, sin holguras.
- Dos tipos de mango:
  - Mangos de madera barnizados, ligeros y de tacto agradable.
  - Mangos bimateriales ergonómicos con acabado SOFT TOUCH para mayor comodidad durante el trabajo.

### Usos:

- Para realizar trabajos de acabado.

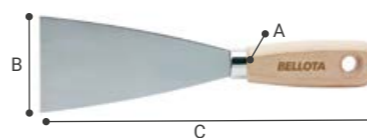

▶ **ESPÁTULA ACERO 5890**

REF.	€	8 41 4299	g	A mm	B mm	C mm	L mm
5890-30	4,25	098013	12	50	25	30	210
5890-40	4,51	098044	12	50	25	40	210
5890-50	4,76	098075	12	60	25	50	210
5890-60	4,86	098105	12	60	25	60	210
5890-70	5,19	098136	12	70	25	70	210
5890-80	5,36	098167	12	70	25	80	210
5890-100	6,91	098228	12	70	25	100	210



▶ **ESPÁTULA ACERO MANGO BIMATERIAL 5890**

REF.	€	8 41 4299	g	A mm	B mm	C mm	L mm
5890-30 BIM	4,49	635089	12	80	25	30	225
5890-40 BIM	4,75	635102	12	80	25	40	225
5890-50 BIM	4,99	635126	12	80	25	50	225
5890-60 BIM	5,27	635140	12	90	25	60	230
5890-70 BIM	5,62	635164	12	90	25	70	230
5890-80 BIM	5,81	635188	12	90	25	80	230
5890-100 BIM	7,25	635201	12	100	25	100	230



▶ ESPÁTULA INOXIDABLE 5893

REF.	€	8 41 4299	g	A mm	B mm	C mm	L mm
5893-40	4,97	120035	12	50	20	40	210
5893-60	5,48	120028	12	60	20	60	210
5893-80	6,07	120042	12	70	20	80	210
5893-100	7,60	120066	12	70	20	100	210



▶ ESPÁTULA LLANA ACERO 5876

REF.	€	8 41 4299	g	A mm	B mm	C mm	L mm
5876	5,14	134032	12	118	16	180	125

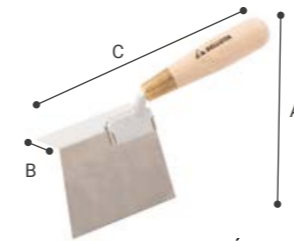

▶ ESPÁTULA ESQUINA INOXIDABLE 5896-E

REF.	€	8 41 4299	g	A mm	B mm	C mm
5896-E	14,86	564525	6	200	110	87

Para ángulos exteriores.



▶ ESPÁTULA RINCÓN INOXIDABLE 5896-R

REF.	€	8 41 4299	g	A mm	B mm	C mm
5896-R	14,38	564549	6	230	105	160

Para ángulos interiores.



▶ ESPÁTULA ANCHA INOXIDABLE MANGO BIMATERIAL 5899

REF.	€	8 41 4299	g	A mm	B mm	C mm	L mm
5899-400 BIM	16,03	623789	6	340	15	400	215
5899-500 BIM	18,08	623802	6	400	15	500	215

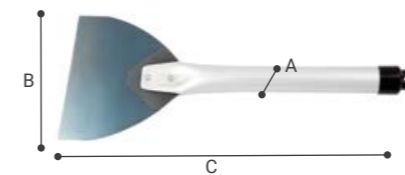

▶ ESPÁTULA ACERO LIGERA 5896

REF.	€	8 41 4299	g	A mm	B mm	C mm
5896-180	24,01	561326	6	250	37	177

Para el repaso de la cinta y / o eliminación de la pasta tras aplicación conbalooka.

## ESPÁTULAS PARA PLACA

### Usos:

- Para encintado y acabado de las juntas de placas de yeso laminado.
- Para masillado de las cabezas de los tornillos.

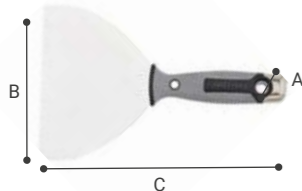

▶ ESPÁTULA INOXIDABLE MANGO BIMATERIAL 5894

REF.	€	8 41 4299	g	A mm	B mm	C mm
5894-150 N	13,92	635225	6	180	20	152

Mango Bimaterial con base y núcleo de aluminio. Gran resistencia ante golpeo de tornillos.



▶ ESPÁTULA INOXIDABLE MANGO BIMATERIAL CON PUNTA 5894

REF.	€	8 41 4299	g	A mm	B mm	C mm
5894-150P N	13,69	635249	6	180	20	152

Mango Bimaterial con base y núcleo de aluminio con Punta PH2. Gran resistencia ante golpeo de tornillos.



▶ ESPÁTULA AMERICANA INOXIDABLE MANGO BIMATERIAL 5900

REF.	€	8 41 4299	g	A mm	B mm	C mm
5900-140	6,32	635263	6	150	20	140
5900-160	6,63	635287	6	170	20	160
5900-180	6,96	635300	6	190	20	180
5900-200	7,30	635324	6	220	20	200



▶ ESPÁTULA AMERICANA INOXIDABLE 5895

REF.	€	8 41 4299	g	A mm	B mm	C mm
5895-200	11,16	564440	6	210	20	204
5895-250	12,63	564464	6	260	24	255
5895-300	12,97	564488	6	270	20	305

## PISTOLAS DE SILICONA

- Pistolas de empuje por fricción, para mayor precisión.
- Ratio de fuerza/efecto multiplicador de 1:10 en pistola 50262 y 1:15 en pistola profesional 50264, para minimizar la fuerza transmitida durante la aplicación.
- Cuerpo en acero para mayor resistencia y durabilidad.

### Usos:

- Para trabajos de instalación, para aplicar cartuchos sellantes en formato 300 ml.

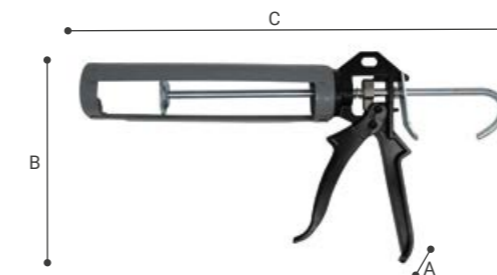

▶ PISTOLA SILICONA 50262

REF.	€	8 41 4299	g	A mm	B mm	C mm
50262	8,56	342239	12	646	55	210

Para silicona.



▶ PISTOLA SILICONA PROFESIONAL 50264

REF.	€	8 41 4299	g	A mm	B mm	C mm
50264	19,48	639094	6	753	60	220

Para materiales de alta viscosidad: siliconas, masillas y selladores de poliuretano.

# MARTILLERÍA



**Irrompible:**  
Fabricado en una sola pieza.

No se te escurrirá:  
Mango con estrías laterales.

Ref. 5308-0 CF

## MAZAS

• Especial trabajos de demolición.

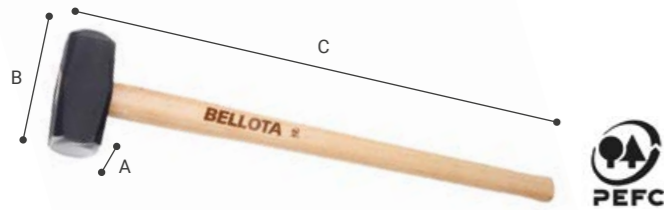

► MAZA 5200

REF.	€	8 41 4299	g	A mm	B mm	C mm	M	Kg
5200-2	38,79	120806	6	2.200	54	125	600	M52002N 1,89
5200-3	46,60	121001	6	3.130	60	140	600	M52003N 2,70 M52004CF
5200-4	56,99	121209	6	4.410	65	156	700	M52004N 3,80 M52004CF
5200-5	68,51	121407	4	5.440	70	170	800	M52005N 4,79 M52006CF
5200-6	79,02	121605	4	6.440	75	180	800	M52006N 5,77 M52006CF
5200-8	97,40	121803	4	8.120	80	195	900	7,27

Madera de haya. Unión perfecta con cuña.



► MAZA MANGO FIBRA DE CARBONO 5200

REF.	€	8 41 4299	g	A mm	B mm	C mm	M	Kg
5200-3 CF	57,58	625172	6	3.500	60	140	700	M52003N 2,70 M52004CF
5200-4 CF	61,54	625196	6	4.490	65	156	700	M52004N 3,80 M52004CF
5200-5 CF	70,28	625219	4	5.680	70	170	900	M52005N 4,79 M52006CF
5200-6 CF	83,36	625233	4	6.780	75	180	900	M52006N 5,77 M52006CF

Unión perfecta.



► MAZA SIN TEMPLAR MANGO FIBRA CARBONO 5200

REF.	€	8 41 4299	g	A mm	B mm	C mm	Kg	
5200-3 0 HRc CF	59,57	695496	6	3.500	60	140	700	2,70

# PICACHONES

- Fabricados con Acero Especial Bellota.
- Forjados en una sola pieza, irrompibles.
- Tratamiento térmico 3+ para alargar la vida útil de la herramienta: no se rompe, no se deforma, no se desgasta.
- Pintura epoxi para evitar la oxidación de la herramienta.

**Usos:**

- Picachones para abrir zanjas y picar piedra

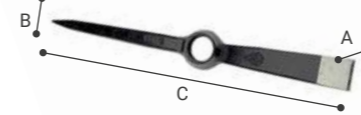

► PICACHÓN 5001

REF.	€	8 41 4299	g	A mm	B mm	C mm	M	Kg
5001-A	29,98	120004	6	2.020	65	60	455	M6900 2,05 M6CF M61200 M61400 M6900SB M61200SB
5001-B	29,26	120103	6	2.450	65	60	485	M6900 2,50 M6CF M61200 M61400 M6900SB M61200SB
5001-C	33,80	120202	6	2.970	85	70	530	M6900 3,00 M6CF M61200 M61400 M6900SB M61200SB
5001-D	39,09	120301	6	3.330	85,1	70	575	M6900 3,50 M6CF M61200 M61400 M6900SB M61200SB



► PICACHÓN CON MANGO 5001

REF.	€	8 41 4299	g	A mm	B mm	C mm	M	Kg
5001-A CM	42,17	142792	2	2.850	60	465	901	M6900 2,05 M6CF M61200 M61400 M6900SB M61200SB
5001-B CM	42,28	638974	2	3.290	60	495	901	M6900 2,50 M6CF M61200 M61400 M6900SB M61200SB

Madera de haya. Unión perfecta con cuña



► PICACHÓN MANGO FIBRA CARBONO 5001

REF.	€	8 41 4299	g	A mm	B mm	C mm	M	Kg
5001-A CF	58,04	638998	2	3.010	60	465	901	M6900 2,05 M6CF M61200 M61400 M6900SB M61200SB
5001-B CF	58,19	639018	2	3.220	60	495	901	M6900 2,50 M6CF M61200 M61400 M6900SB M61200SB



► PICACHÓN 5016

REF.	€	8 41 4299	g	A mm	B mm	C mm	M	Kg
5016-00	30,21	182651	6	1.500	45	55	505	M501600 1,50



► PICACHÓN CON MANGO 5016

REF.	€	8 41 4299	g	A mm	B mm	C mm	M	Kg
5016-00 CM	43,20	225167	6	2.390	55	505	905	M501600 1,50

## MACETAS

- Para golpeo de materiales diversos en obra y apertura de rozas junto con cincel o cortafrío.
- Nuevo diseño de mangos: gran comodidad de agarre y excelente sensación en la mano.
- Nuevo diseño de ojos: ovalados para mejorar la comodidad durante el trabajo evitando el giro del mango.



▶ MACETA 5308

REF.	€	8 41 4299	g	A mm	B mm	C mm	M	Kg
5308-0 N	18,44	624731	6 890	45	109	280	M53080N	0,70
							M5308CF	
5308-A N	20,22	353143	6 1.160	45	125	280	M5308AN	1,00
							M5308CF	
5308-B N	22,64	353198	6 1.400	49	130	280	M5308BN	1,30
							M5308CF	

Madera de haya. Unión perfecta con cuña.



▶ MACETA MANGO FIBRA CARBONO 5308

REF.	€	8 41 4299	g	A mm	B mm	C mm	M	Kg
5308-0 CF	21,09	625028	6 880	45	109	270	M53080N	0,70
							M5308CF	
5308-A CF	23,43	625059	6 1.140	45	125	270	M5308AN	1,00
							M5308CF	
5308-B CF	26,30	625073	6 1.430	49	134	270	M5308BN	1,30
							M5308CF	

Unión perfecta



▶ MACETA CUADRADA 5310

REF.	€	8 41 4299	g	A mm	B mm	C mm	M	Kg
5310-A	18,99	661231	6 940	40	88	280	M5308CF	0,80
							M5310A	
5310-B	20,83	661316	6 1.190	40	95	280	M5308CF	0,98
							M5310A	
5310-C	23,34	661415	6 1.350	43	100	280	M5308CF	1,16
							M5310C	
5310-D	25,76	661491	6 1.630	45	110	280	M5308CF	1,50
							M5310C	

Madera de haya. Unión perfecta con cuña.



▶ MACETA CUADRADA MANGO FIBRA CARBONO 5310

REF.	€	8 41 4299	g	A mm	B mm	C mm	M	Kg
5310-A CF	21,69	625097	6 950	40	88	270	M5308CF	0,80
							M5310A	
5310-B CF	24,14	625110	6 1.120	40	95	270	M5308CF	0,98
							M5310A	
5310-C CF	27,09	625134	6 1.340	43	100	272	M5308CF	1,16
							M5310C	
5310-D CF	29,43	625158	6 1.630	45	110	270	M5308CF	1,50
							M5310C	

Unión perfecta



▶ MACETA CON PEÑA 5312

REF.	€	8 41 4299	g	A mm	B mm	C mm	M	Kg
5312-400	22,97	040432	6 1.350	55	170	400	M5312	1,08

Madera de haya.



▶ MAZA CANTERO 5305

REF.	€	8 41 4299	g	A mm	B mm	C mm	M	Kg
5305-0	31,06	249163	6 1.070	65	65	235	M5305	1,00
5305-A	33,11	123302	6 1.280	68	68	235	M5305	1,25

Madera de haya. Unión perfecta con cuña.



## ALCOTANAS

- Para picado y revoque de superficies.
- Nuevo diseño de mangos: gran comodidad de agarre y excelente sensación en la mano.
- Nuevo diseño de ojos: ovalados para mejorar la comodidad durante el trabajo evitando el giro del mango.

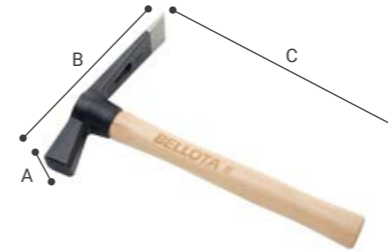

▶ ALCOTANA PALA-MARTILLO 5931

REF.	€	8 41 4299	g	A mm	B mm	C mm	M	Kg
5931-A N	26,18	631777	6 830	45	200	310	M5931AN	0,69
5931-B N	28,86	631814	6 950	50	215	335	M5931BN	0,81

Madera de haya. Unión perfecta con cuña.



▶ ALCOTANA PALA-MARTILLO 5931

REF.	€	8 41 4299	g	A mm	B mm	C mm	M	Kg
5931-A CF	34,61	631999	6 900	45	200	310	M5931AN	0,81

Unión perfecta



▶ ALCOTANA HACHA-PALA 5932

REF.	€	8 41 4299	g	A mm	B mm	C mm	M	Kg
5932-00 N	23,68	631852	6 540	38	200	290	M59310N	0,41
5932-0 N	25,24	631876	6 720	39	265	290	M59310N	0,54
5932-A N	25,45	631890	6 800	40	290	310	M5931AN	0,73
5932-B N	29,22	631913	6 1.010	44	315	335	M5931BN	0,84

Madera de haya. Unión perfecta con cuña.



▶ ALCOTANA HACHA-PALA MANGO FIBRA CARBONO 5932

REF.	€	8 41 4299	g	A mm	B mm	C mm	M	Kg
5932-0 CF	33,31	632019	6 730	38	265	289	M59310N	0,54
5932-A CF	33,60	632033	6 940	40	290	305	M5931AN	0,73

Unión perfecta



▶ ALCOTANA PICO-PALA 5933

REF.	€	8 41 4299	g	A mm	B mm	C mm	M	Kg
5933-00 N	23,95	631937	6 540	38	210	290	M59310N	0,36
5933-0 N	23,91	631951	6 590	40	270	290	M59310N	0,47
5933-A N	25,66	631975	6 800	41	305	310	M5931AN	0,62

Madera de haya. Unión perfecta con cuña.



▶ ALCOTANA PICO-PALA MANGO FIBRA CARBONO 5933

REF.	€	8 41 4299	g	A mm	B mm	C mm	M	Kg
5933-0 CF	31,49	632057	6 660	40	270	290	M59310N	0,47
5933-A CF	33,91	632071	6 870	41	305	310	M5931AN	0,62

Unión perfecta



▶ ALCOTANA SKEPARNI 5938

REF.	€	8 41 4299	g	A mm	B mm	C mm	M	Kg
5938-SM	22,17	999457	12 340	41,5	115,5	30	M5938	0,33

## MARTILLOS

- Para golpeo de piezas, principalmente chapa o acero ensamblajes, remaches, puntos de soldadura y ajuste mecánicos en general.



▶ MARTILLO EBANISTA 8005

REF.	€	INFORMACIÓN	g	A mm	B mm	C mm	M	Kg
8005-16	13,13	139402	6	130	18	78	250	M800516 0,10
8005-A	11,95	138207	6	190	20	85	280	M8005A 0,14
8005-B	12,11	138504	6	250	23	90	280	M8005B 0,18
8005-C	13,11	138801	6	330	25	100	300	M8005C 0,23
8005-D	14,83	139006	6	430	28	105	300	M8005D 0,32
8005-E	16,13	139105	6	500	30	115	325	M8005E 0,44
8005-F	17,37	139204	6	620	33	120	325	M8005F 0,55

Madera de haya. Unión perfecta con cuña.



▶ MARTILLO EBANISTA MANGO FIBRA CARBONO 8005

REF.	€	INFORMACIÓN	g	A mm	B mm	C mm	Kg
8005-A CF	18,68	634051	6	250	20	85	270 0,14
8005-B CF	19,49	634075	6	310	23	90	275 0,18
8005-C CF	21,10	634099	6	420	25	100	295 0,23
8005-D CF	22,41	634112	6	510	28	105	295 0,32
8005-E CF	24,40	634136	6	600	30	115	320 0,44

Unión perfecta.



▶ MARTILLO CARPINTERO 8002

REF.	€	INFORMACIÓN	g	A mm	B mm	C mm	M	Kg
8002-13	20,55	363708	6	480	25	120	300	M800213 0,35
8002-16	22,29	611915	6	610	32	130	325	M800216 0,45
8002-20	23,63	611939	6	690	34	135	325	M800220 0,54
8002-24	25,56	611953	6	840	37	150	345	M800224 0,66

Extracción de puntas desde 0-1 mm. Madera de haya. Unión perfecta con cuña.



▶ MARTILLO CARPINTERO MANGO FIBRA CARBONO 8002

REF.	€	INFORMACIÓN	g	A mm	B mm	C mm	Kg
8002-13 CF	24,14	625271	6	550	25	120	300 0,35
8002-16 CF	26,21	625295	6	690	32	130	325 0,45
8002-20 CF	27,77	625318	6	770	34	135	325 0,54
8002-24 CF	30,00	625332	6	920	37	150	336 0,66

Extracción de puntas desde 0-1 mm. Unión perfecta.



▶ MARTILLO CARPINTERO MANGO FIBRA CARBONO 8003

REF.	€	INFORMACIÓN	g	A mm	B mm	C mm	Kg
8003-20 CF	28,35	625356	6	770	31	150	320 0,57

Extracción de puntas desde 0-1 mm. Unión perfecta.

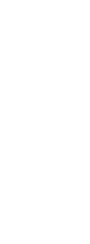

▶ MARTILLO CARPINTERO-ENCOFRADOR MANGO FIBRA CARBONO 8006

REF.	€	INFORMACIÓN	g	A mm	B mm	C mm	Kg
8006 CF	30,54	625370	6	780	30	170	325 0,57

Unión perfecta.



▶ MARTILLO CARPINTERO 8007

REF.	€	INFORMACIÓN	g	A mm	B mm	C mm	M	Kg
8007-A	20,16	139600	6	480	38	105	300	M8007A 0,35
8007-B	21,71	139808	6	570	41	115	300	M8007B 0,45
8007-C	22,23	140002	6	670	44	120	335	M8007C 0,54
8007-D	24,38	140101	6	800	47	130	345	M8007D 0,68
8007-E	25,62	140200	6	920	49	135	360	M8007E 0,78
8007-F	29,36	140309	6	1.090	52	142	370	M8007F 0,89

Extracción de puntas desde 0-1 mm. CI: modelos con imán. Madera de haya. Unión perfecta con cuña.



▶ MARTILLO ENCOFRADOR 8017

REF.	€	INFORMACIÓN	g	A mm	B mm	C mm	M	Kg
8017-0 CI	22,29	458312	6	400	35	122	450	M80170 0,25 M8017A
8017-A CI	22,42	159073	6	450	39	130	450	M8017A 0,31
8017-B	24,45	143102	6	540	42	136	450	M8017B 0,40
8017-C	26,04	143201	6	700	45	150	450	M8017C 0,49
8017-D	29,66	143300	6	840	47	160	450	M8017D 0,59

Extracción de puntas desde 0-1 mm. CI: modelos con imán. Madera de haya.



▶ MARTILLO ENCOFRADOR 8017

REF.	€	INFORMACIÓN	g	A mm	B mm	C mm	M	Kg
8017-0 CI SM	18,55	466126	12	230	30	35	125	M8030 0,25
8017-A CI SM	19,30	422436	12	280	39	36	130	M8030 0,31

Extracción de puntas desde 0-1 mm. CI: modelos con imán. Madera de haya.



▶ MARTILLO ENCOFRADOR 8030

REF.	€	INFORMACIÓN	g	A mm	B mm	C mm	M	Kg
8030 CI	26,12	469851	6	860	40	170	450	M8030 0,72 M8030CF

Extracción de puntas desde 0-1 mm. CI: modelos con imán.



▶ MARTILLO ENCOFRADOR MANGO FIBRA CARBONO 8030

REF.	€	INFORMACIÓN	g	A mm	B mm	C mm	M	Kg
8030 CI CF	33,26	439816	6	1.040	40	170	450	M8030 0,72 M8030CF

Extracción de puntas desde 0-1 mm. CI: modelos con imán. Unión perfecta. Modelo de utilidad registrado.



▶ MARTILLO-HACHA 8008

REF.	€	INFORMACIÓN	g	A mm	B mm	C mm	M	Kg
8008	35,54	140408	6	837	30	170	370	M8008 0,57

Madera de haya. Unión perfecta con cuña.



▶ MARTILLO MECÁNICO BOLA 8011

REF.	€	INFORMACIÓN	g	A mm	B mm	C mm	M	Kg
8011-A	16,27	141009	6	300	25	80	295	M8011A 0,23
8011-B	16,85	141207	6	370	29	90	297	M8011B 0,32
8011-C	17,52	141405	6	520	32	100	319	M8011C 0,42
8011-D	18,95	141603	6	660	34	110	315	M8011D 0,54
8011-E	20,73	141702	6	860	35	120	350	M8011E 0,70
8011-F	22,51	141801	6	1.040	39	129	350	M8011F 0,87
8011-G	24,44	141900	6	1.280	40	137	390	M8011G 1,07
8011-H	27,75	142006	6	1.420	43	145	390	M8011H 1,32

Madera de haya. Unión perfecta con cuña.



▶ MARTILLO MECÁNICO BOLA MANGO FIBRA CARBONO 8011

REF.	€	INFORMACIÓN	g	A mm	B mm	C mm	M	Kg
8011-C CF	29,19	634150	6	630	32	100	310	M8011C 0,42
8011-D CF	31,63	634174	6	760	34	110	315	M8011D 0,54
8011-E CF	34,52	634198	6	970	35	120	345	M8011E 0,70
8011-F CF	37,51	634211	6	1.150	39	129	351	M8011F 0,87
8011-G CF	40,67	634235	6	1.370	40	137	375	M8011G 1,07

Unión perfecta.





#### MARTILLO MECÁNICO PEÑA 8009

REF.	€	8 41 4299	g	A mm	B mm	C mm	M	Kg
8009-A	20,83	140507	6	400	27	94	295	M8011B 0,32
8009-B	23,40	140606	6	540	30	105	320	M8011C 0,42
8009-C	23,77	140705	6	660	34	115	320	M8011C 0,54
8009-D	25,67	140804	6	810	36	123	347	M8011E 0,70
8009-E	28,25	140903	6	1.050	39	133	350	M8011F 0,87

Madera de haya. Unión perfecta con cuña.



#### MARTILLO MECÁNICO PEÑA MANGO FIBRA CARBONO 8009

REF.	€	8 41 4299	g	A mm	B mm	C mm	M	Kg
8009-C CF	37,95	639483	6	760	34	115	315	M8011C 0,54
8009-E CF	41,60	639506	6	1.150	39	133	349	M8011E 0,87

Unión perfecta.



#### MARTILLO CALDERERO 5454

REF.	€	8 41 4299	g	A mm	B mm	C mm	M	Kg
5454-450	18,62	072211	6	590	30	170	325	M8005E 0,45

Madera de haya. Unión perfecta con cuña.



#### MARTILLO ALEMÁN 28018

REF.	€	8 41 4299	g	A mm	B mm	C mm	Kg
28018B	9,51	705119	6	180	15	82	260 0,10
28018C	10,64	705133	6	300	19	95	280 0,20
28018D	11,20	705157	6	400	23	105	300 0,30
28018F	12,89	705171	6	680	27	118	320 0,50
28018I	17,38	705232	6	1.260	36	135	360 1,00
28018G	14,01	705195	6	700	29	122	330 0,60
28018H	15,70	705218	6	800	33	130	350 0,80

## MARTILLOS SIN TEMPLAR

- Nuevos modelos sin temprar:
- Para golpear materiales de gran dureza y evitar la aparición de esquirlas.
- Máxima Seguridad. Durante el golpeo el martillo irá perdiendo su forma, pero no su masa, lo que permitirá seguir trabajando asegurando la máxima seguridad del usuario.



#### MACETA SIN TEMPLAR MANGO FIBRA CARBONO 5308

REF.	€	8 41 4299	g	A mm	B mm	C mm	M	Kg
5308-A 0 HRc CF	24,14	635522	6	1.150	45	125	270	M5308CF 1,00

Unión perfecta. Golpeo de materiales duros > 46 HRc.



#### MARTILLO MECÁNICO SIN TEMPLAR MANGO FIBRA CARBONO 8011

REF.	€	8 41 4299	g	A mm	B mm	C mm	Kg
8011-F 0 HRc CF	37,98	635546	6	1.160	39	129	350 0,87

Unión perfecta. Golpeo de materiales duros > 46 HRc.

## MARTILLOS DE NYLON

- Para golpeo de piezas, principalmente chapa o acero ensamblajes, remaches, puntos de soldadura y ajuste mecánicos en general.



#### MARTILLO BOCAS NYLON 8050

REF.	€	8 41 4299	g	A mm	B mm	C mm	M	Kg
8050-25	15,99	530476	6	250	25	100	270	BB805025 0,19 M805025
8050-32	18,58	530513	6	350	32	102	270	BB805032 0,30 M805032
8050-38	24,01	530551	6	530	38	110	270	BB805038 0,50 M805038
8050-44	33,42	530599	6	770	40	120	315	BB805044 0,63 M805044

Madera de haya. Unión perfecta con cuña.



#### MARTILLO ANTIREBOTE BOCAS NYLON 8051

REF.	€	8 41 4299	g	A mm	B mm	C mm	M	Kg
8051-38	45,75	608564	6	680	38	138	300	BB805038 0,75
8051-44	53,77	608601	6	950	44	144	318	BB805044 0,95
8051-50	63,04	608649	3	1.190	50	151	330	BB805050 1,25
8051-63	94,29	608687	3	1.870	63	165	355	BB805063 2,00

Extracción de puntas desde 0-1 mm. Madera de haya. Unión perfecta con cuña.



#### BOCAS DE RECAMBIO PARA MARTILLOS 8050-8051

REF.	€	8 41 4299	g	A mm	B mm	C mm	Kg
BB 8050-25	3,85	531312	12	10	25	20	25 0,00
BB 8050-32	4,82	531350	12	20	32	102	30 0,00
BB 8050-38	5,99	531398	12	20	38	110	36 0,00
BB 8050-44	7,12	531435	12	40	44	120	45 0,00
BB 8050-50	9,20	531473	12	50	50	140	50 0,00
BB 8050-63	12,21	573756	12	70	63	165	65 0,00

## MACETAS DE GOMA

- Cabeza fabricada en goma de caucho isopreno de alta calidad: máxima duración y resistencia.
- Sin olor, sin cristalización.
- Excelente rebote que asegura la precisión y comodidad de uso durante el golpeo, además de la protección del material cerámico con el que se trabaje.
- Mangos de madera de haya barnizados, ligeros y de tacto agradable. Certificados PEFC.

#### Usos:

- En general para operaciones de golpeo.
- En especial para trabajos de alicatado, ajuste de piezas cerámicas durante su colocación.



#### MACETA GOMA 8053

REF.	€	8 41 4299	g	A mm	B mm	C mm	M	Kg
8053-250	11,19	598179	6	320	100	60	320	M8053250 0,25
8053-500	14,11	598193	6	640	130	80	360	M8053500 0,50
8053-750	18,92	598216	6	890	140	90	360	M8053750 0,75

Especial para trabajos de alicatado y para usos genéricos de ajuste.



#### MACETA GOMA 8054

REF.	€	8 41 4299	g	A mm	B mm	C mm	M	Kg
8054-250	11,99	598230	6	360	100	60	320	M8053250 0,25
8054-500	14,87	598254	6	640	130	70	360	M8053500 0,50
8054-750	19,86	598278	6	960	140	85	360	M8053750 0,75

Especial para no marcar la superficie trabajada.

# CINCELES

- Fabricados con Acero Especial Bellota: Cromo vanadio.
- Tratamiento térmico 3+ para alargar la vida útil de la herramienta: no se rompe, no se deforma, no se desgasta.
- Tratamiento diferenciado en tres zonas cabeza, cuerpo y punta, y exhaustivo control de las durezas resultantes para garantizar la nula aparición de esquirlas. Máxima seguridad durante el trabajo.
- Puntas rectificadas, biseladas y barnizadas.
- Respeto al medio ambiente.
- Protector con tres labios para mayor protección de la mano

## PUNTEROS

- Para apertura de rozas en operaciones de rotura en general.
- Para eliminar restos de hormigón u otros materiales en soportes de obra.

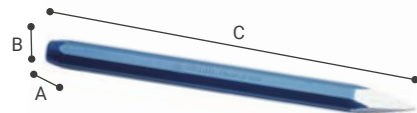

► PUNTERO OCTOGONAL 5821

REF.	€	8 41 4299	g	A mm	B mm	C mm	L mm	
5821-14x200	9,90	127706	6	230	14	14	200	14
5821-14x250	10,51	127904	6	290	14	14	250	14
5821-16x200	10,31	128109	6	290	16	16	200	16
5821-16x250	11,16	128208	6	380	16	16	250	16
5821-16x300	11,49	128307	6	460	16	16	300	16
5821-16x350	12,56	128406	6	540	16	16	345	16
5821-18x250	11,92	128604	6	470	18	18	250	18
5821-18x300	12,92	128703	6	570	18	18	300	18
5821-18x350	13,79	128802	6	680	18	18	350	18
5821-18x400	14,87	128901	6	800	18	18	400	18



► PUNTERO OCTOGONAL CON PROTECTOR 5821

REF.	€	8 41 4299	g	A mm	B mm	C mm	L mm	
5821-14x250 CP	14,23	037944	6	510	85	100	250	14
5821-16x250 CP	14,87	038125	6	590	85	100	250	16
5821-16x300 CP	15,22	038163	6	660	85	100	300	16
5821-18x250 CP	15,56	038200	6	670	85	100	250	18
5821-18x300 CP	16,69	038248	6	800	85	100	300	18
5821-18x350 CP	17,45	038286	6	900	85	100	350	18
5821-18x400 CP	18,36	360547	6	1.000	85	100	400	18

## CINCELES OCTOGONALES



► CINCEL OCTOGONAL 5825

REF.	€	8 41 4299	g	A mm	B mm	C mm	L mm	
5825-14x200	9,99	129502	6	240	14	20	200	14
5825-14x250	10,74	129700	6	300	14	20	250	14
5825-16x200	10,74	129908	6	310	16	23	200	16
5825-16x250	11,49	130003	6	390	16	23	250	16
5825-16x300	11,63	130102	6	470	16	23	300	16
5825-16x350	12,50	130201	6	560	16	23	350	16
5825-18x250	12,09	130409	6	480	18	26	250	18
5825-18x300	13,28	130508	6	590	18	26	300	18
5825-18x350	14,28	130607	6	710	18	26	350	18
5825-18x400	15,20	130706	6	790	18	26	400	18
5825-20x300	14,57	130805	6	740	20	30	300	20



► CINCEL OCTOGONAL CON PROTECTOR 5825

REF.	€	8 41 4299	g	A mm	B mm	C mm	L mm	
5825-14x250 CP	14,33	038446	6	510	85	100	250	14
5825-16x250 CP	14,99	038484	6	600	85	100	250	16
5825-16x300 CP	15,27	038521	6	680	85	100	300	16
5825-18x250 CP	15,74	038569	6	700	85	100	250	18
5825-18x300 CP	16,88	038606	6	800	85	100	300	18
5825-18x350 CP	17,70	038644	6	900	85	100	350	18
5825-18x400 CP	18,57	360615	6	1.020	85	100	400	18

## CORTAFRÍOS



► CORTAFRÍO 8251

REF.	€	8 41 4299	g	A mm	B mm	C mm	L mm	
8251-150	8,79	660609	6	190	11	20	150	17
8251-175	9,40	146004	6	180	11	18	175	18
8251-200	10,21	146103	6	330	12	23	200	22
8251-225	11,28	146301	6	370	12	22	225	22
8251-250	12,44	146400	6	490	12	22	250	25
8251-300	13,66	146509	6	600	12	25	300	25
8251-350	15,46	146608	6	720	12	25	350	25
8251-400	17,13	146707	6	810	12	25	400	25



► CORTAFRÍO CON PROTECTOR 8251

REF.	€	8 41 4299	g	A mm	B mm	C mm	L mm	
8251-250 CP	16,13	038804	6	700	85	100	250	25
8251-300 CP	17,58	038842	6	800	85	100	300	25
8251-350 CP	19,12	038880	6	960	85	100	350	25
8251-400 CP	20,89	038927	6	990	85	100	400	25



► PROTECTOR CORTAFRÍO

REF.	€	8 41 4299	g	A mm	B mm	C mm	
M8251-25X12BIM	5,40	663341	12	220	98	85	130

## PALA ANCHA



► CINCEL PALA ANCHA 8271

REF.	€	8 41 4299	g	A mm	B mm	C mm	L mm	
8271-60	12,07	624816	6	460	13	60	230	23
8271-70	13,04	037241	6	450	13	70	230	23
8271-80	15,52	037272	6	540	13	80	230	26
8271-90	18,58	624847	6	580	13	90	230	26
8271-100	22,69	624878	6	570	13	100	230	26

\* 8271-90/8271-100 DISPONIBILIDAD HASTA FIN DE EXISTENCIAS.



► CINCEL PALA ANCHA CON PROTECTOR 8271

REF.	€	8 41 4299	g	A mm	B mm	C mm	L mm	
8271-60 CP	16,87	624908	6	660	85	100	230	23
8271-80 CP	20,97	624922	6	760	85	100	230	26

\* 8271-100 CP: DISPONIBILIDAD HASTA FIN DE EXISTENCIAS.

## CINCELES PARA EL TALLER

- Para apertura de canales, incluso en zonas de difícil acceso.
- Para eliminar puntos de soldadura y otros restos.



► BURIL MECÁNICO 8241

REF.	€	8 41 4299	g	A mm	B mm	C mm	L mm	
8241-175	17,84	145700	6	200	22	11	175	17
8241-200	19,55	145809	6	300	28	12	200	20
8241-250	21,56	145908	6	480	25	12	250	23



► CINCEL MECÁNICO 8245

REF.	€	8 41 4299	g	A mm	B mm	C mm	L mm	
8245-200	11,07	660647	6	340	12	26	200	22
8245-250	11,50	660685	6	400	12	26	250	22
8245-300	12,44	660722	6	610	12	29	300	23
8245-350	12,55	660760	6	700	12	29	350	23



# MEZCLADORAS Y VARILLAS

- Motor con regulación electrónica de la velocidad que adapta la potencia útil en función de la densidad y cantidad del material que se esté mezclando. Además posibilita un arranque suave que evita que el material a mezclar salpique hacia fuera de forma incontrolada.
- Gran comodidad gracias al botón en el asa que posibilita fijar la velocidad sin tener que apretar el gatillo constantemente, y al selector de velocidad que permite regular la velocidad fácilmente.
- Empuñaduras bimateriales con acabado SOFT TOUCH para mayor comodidad durante el trabajo.
- Inclinación de 20° para una mayor ergonomía.

**Usos:**

- Para realizar mezclas homogéneas de morteros, cementos, resinas, pinturas y colas.
- VARILLA 50787: Especialmente recomendada para morteros adhesivos, masilla tapagrietas, cemento cola, mortero rápido, morteros, revoques y pavimentos.
- VARILLA 50788: Especialmente recomendada para morteros adhesivos, cemento cola y mortero rápido.



► MEZCLADORA M12LIGHT

REF.	€	8 41 4299	g	A mm	B mm	C mm	
MCM12LIGHT	149,95	607567	1	4.670	225	315	870
MCM12LIGHT230V	149,95	638820	1	4.740	225	315	870

Incluye una varilla de 120 mm de diámetro, 2 llaves fijas, 2 escobillas y un manual de instrucciones con su bono de garantía y certificado.



**NEW**

► MEZCLADORA M14

REF.	€	8 41 4299	g	A mm	B mm	C mm	
M14	134,95	022292	1	5.385	180	325	890
M14110V	134,95	022490	1	5.385	180	325	890
M14230V	134,95	051940	1	5.385	180	325	890

Incluye una varilla de 120 mm de diámetro, 2 llaves fijas, 2 escobillas y un manual de instrucciones con su bono de garantía y certificado.



**NEW**

► MEZCLADORA M16

REF.	€	8 41 4299	g	A mm	B mm	C mm	
M16	144,95	042719	1	5.680	180	325	890

Incluye una varilla de 140 mm de diámetro, 2 llaves fijas, 2 escobillas y un manual de instrucciones con su bono de garantía y certificado.



**NEW**

► MEZCLADORA M18

REF.	€	8 41 4299	g	A mm	B mm	C mm	
M18	186,80	710595	1	6.000	200	350	885
M18CASE	212,05	710618	1	6.000	200	350	885
M18230V	186,80	051995	1	6.000	200	350	885
M18230VCASE	212,05	075533	1	6.000	200	350	885

Incluye una varilla de 140 mm de diámetro, 2 llaves fijas, 2 escobillas y un manual de instrucciones con su bono de garantía y certificado.

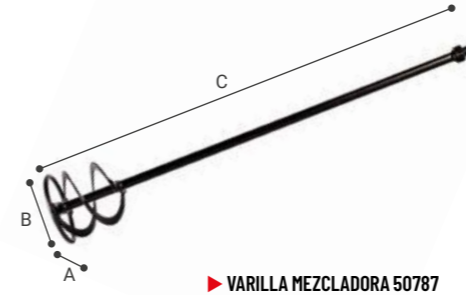

► VARILLA MEZCLADORA 50787

REF.	€	8 41 4299	g	A mm	B mm	C mm	
50787-70	21,09	282122	6	330	70	70	492
50787-100	28,76	282252	2	820	95	95	595
50787-120	31,24	282320	2	990	130	130	600
50787-140	44,32	282375	2	1.210	138	138	605



► VARILLA MEZCLADORA 50788

REF.	€	8 41 4299	g	A mm	B mm	C mm	
50788-85	18,95	282498	6	380	80	80	496
50788-115	18,93	282566	6	740	90	90	600



**NEW**

► VARILLA MEZCLADORA MK1HEX

REF.	€	8 41 4299	g	A mm	B mm	C mm	
MK180HEX8	13,32	022544	16	230	80	80	400
MK1100HEX10	15,09	022582	16	490	100	100	590

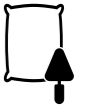

**NEW**

► VARILLA MEZCLADORA MK6HEX

REF.	€	8 41 4299	g	A mm	B mm	C mm	
MK6100HEX10	15,55	022728	16	820	100	100	590



**NEW**

► VARILLA MEZCLADORA MK5M14

REF.	€	8 41 4299	g	A mm	B mm	C mm	
MK5120M14	16,43	023022	2	880	120	120	590



**NEW**

► VARILLA MEZCLADORA MK7M14

REF.	€	8 41 4299	g	A mm	B mm	C mm	
MK7120M14	16,43	023237	2	880	120	120	590



**NEW**

► VARILLA MEZCLADORA MK4M14

REF.	€	8 41 4299	g	A mm	B mm	C mm	
MK4120M14	17,41	023381	2	1.070	120	120	590
MK4140M14	18,77	024272	2	1.190	140	140	590
MK4160M14	20,13	024388	12	1.290	160	160	590

# CUBOS Y CAPAZOS

## CUBOS Y CAPAZOS DE CAUCHO

- Fabricados con caucho resistente que proporciona una alta capacidad para absorber impactos, golpes y caídas. Alta resistencia térmica y química.
- Interior y paredes reforzados para evitar roturas.
- Cubo de caucho Industrial Plano, que permite andar sin entorpecer las piernas, rasear el suelo o encajarlo fácilmente contra una escalera.

### Usos:

- Para trabajos exigentes: mezclado, transporte de escombros, agua y áridos en sectores agrícolas, construcción e industria.

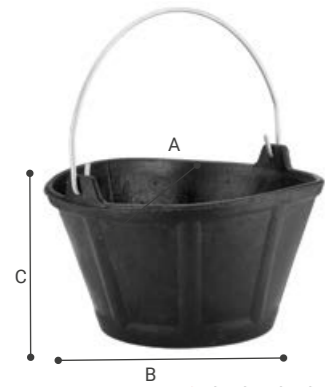

► CUBO DE CAUCHO ITALIANO 10L

REF.	€	8 41 4299	g	A mm	B mm	C mm	L
BKC10BM	9,96	006940	1	1.300	370	370	220 10



► CUBO DE CAUCHO ESPUERTA TIL

REF.	€	8 41 4299	g	A mm	B mm	C mm	L
BKCESPU11BP	9,73	007800	1	1.700	400	470	200 11



► CUBO DE CAUCHO ESPUERTA 4 ASAS 37L

REF.	€	8 41 4299	g	A mm	B mm	C mm	L
BKCESPU37BP	23,19	008296	1	3.500	560	540	380 37



► GAVETA DE CAUCHO 8L

REF.	€	8 41 4299	g	A mm	B mm	C mm	L
BKCGAVE8BP	11,49	047394	5	2.000	364	484	125 8



► GAVETA DE CAUCHO 14L

REF.	€	8 41 4299	g	A mm	B mm	C mm	L
BKCGAVE14BP	17,20	008364	10	670	320	340	230 14



► GAVETA DE CAUCHO 15L

REF.	€	8 41 4299	g	A mm	B mm	C mm	L
BKCGAVE15BP	17,20	015355	1	2.640	436	546	170 15



► CARBONERA DE CAUCHO 18L

REF.	€	8 41 4299	g	A mm	B mm	C mm	L
BKCCARB18BP	12,49	047134	5	2.100	420	453	260 18



► CARBONERA DE CAUCHO 30L

REF.	€	8 41 4299	g	A mm	B mm	C mm	L
BKCCARB30BP	17,50	008395	1	3.100	430	470	275 30



► CUBO DE CAUCHO INDUSTRIAL CON PICO 12L

REF.	€	8 41 4299	g	A mm	B mm	C mm	L
BKCIND12BM	13,48	015843	1	1.840	320	340	230 12



► CUBO DE CAUCHO INDUSTRIAL PLANO 13L

REF.	€	8 41 4299	g	A mm	B mm	C mm	L
BKCIND13BM	13,83	011708	1	800	320	340	230 13



► CUBO CANARIO 18L

REF.	€	8 41 4299	g	A mm	B mm	C mm	L
BKCCAN18BP	12,99	008852	5	2.500	340	441	338 18



► CUBO NORTEÑO DE CAUCHO 13L

REF.	€	8 41 4299	g	A mm	B mm	C mm	L
BKCNOR13BP	12,99	047417	5	2.640	452	452	226 13



► CUBO DE CAUCHO SPART 9L

REF.	€	8 41 4299	g	A mm	B mm	C mm	L
BKCSPART9BP	11,49	008456	1	1.500	415	455	240 9

## CUBOS Y CAPAZOS DE PLÁSTICO

- Fabricados con polietileno 100% reciclado y de gran calidad. Capazos duraderos, estables, de fácil limpieza y con una alta resistencia térmica y química.
- Resistirán todos los impactos: Gran flexibilidad y ligereza que facilita el transporte de materiales y el apilado. Además, el interior y las asas están reforzadas para evitar roturas.
- Con certificado alimentario para garantizar el transporte de frutas y verduras.

### Usos:

- Para el transporte de escombros, agua y áridos en sectores agrícolas y construcción.
- Con certificado alimentario: fruta y verdura.



► CAPAZO NEGRO DE PLÁSTICO CON ASA DE METAL 26L

REF.	€	8 41 4299	g	A mm	B mm	C mm	L
BKT26BM	4,98	676419	12	660	360	390	26



► CAPAZO NEGRO DE PLÁSTICO 26L

REF.	€	8 41 4299	g	A mm	B mm	C mm	L
BKT26BP	4,20	676495	12	540	350	400	26



► CAPAZO NEGRO DE PLÁSTICO

REF.	€	8 41 4299	g	A mm	B mm	C mm	L
BKT42BP	5,65	676730	12	980	520	450	42
BKT65BP	9,77	676815	6	1.520	560	615	65



► CAPAZO ROJO DE PLÁSTICO 42L

REF.	€	8 41 4299	g	A mm	B mm	C mm	L
BKT42RP	6,51	676655	12	980	520	450	42



► CAPAZO BLANCO PARA USO ALIMENTARIO

REF.	€	8 41 4299	g	A mm	B mm	C mm	L
BKT42WP	10,54	676891	12	890	520	450	42
BKT65WP	15,24	677096	6	1.410	560	615	65



► CAPAZO AZUL PARA USO ALIMENTARIO

REF.	€	8 41 4299	g	A mm	B mm	C mm	L
BKT42BLP	10,54	676969	12	890	520	450	42
BKT65BLP	15,24	677010	6	1.420	560	615	65



► CALDERETA CON ASA DE METAL 10L

REF.	€	8 41 4299	g	A mm	B mm	C mm	L
BKW10BM	6,18	678376	12	670	320	340	11



► CALDERETA 13L

REF.	€	8 41 4299	g	A mm	B mm	C mm	L
BKW13BLM	3,02	680973	24	380	300	310	13
BKW16BLM	4,26	679069	12	630	320	350	16



► CAPAZO NEGRO DE PLÁSTICO 30L

REF.	€	8 41 4299	g	A mm	B mm	C mm	L
BKT30BP	5,12	676570	12	630	475	420	30

## GAVETILLA

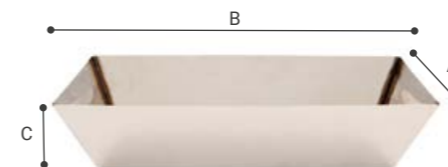

► GAVETILLA 50271

REF.	€	8 41 4299	g	A mm	B mm	C mm	L
50271	26,29	564600	2	591	120	354	2,9

# CORTADORAS DE CERÁMICA Y ACCESORIOS

1  
2  
3

- ▶ **Corte preciso:**  
Bases más estables y guías de acero macizo para garantizar el corte.
- ▶ **Robustas:**  
Herramientas sólidas y preparadas para uso intensivo.
- ▶ **Transporte fácil:**  
Base y torretas de aluminio para facilitarte la movilidad. Trolley con ruedas para la gama TECH y NEO.

## CARACTERÍSTICAS

## USOS

### CORTADORA LEAN

- ▶ Permite cortar hasta 3.200 mm y espesor de 12 mm.
- ▶ Construida con materiales resistentes y duraderos para una larga vida útil de la herramienta.
- ▶ Incluye accesorio indicador de rayado, rulina de 22 mm y bolsa de transporte.

- ▶ Para láminas cerámicas de gran formato (Slab) y cerámicas finas de hasta 12 mm de espesor.

### CORTADORA NEO

- ▶ Permite cortar hasta 1.550 mm y espesor 18 mm.
- ▶ Estructura monoguía robusta y precisa con un potente sistema de separación.
- ▶ Incluye maleta trolley con ruedas, tope escuadra, soportes laterales y rulina de diámetro 22 mm.

- ▶ Concebida para trabajar con grandes formatos.
- ▶ La mejor compañera para el instalador profesional con las necesidades más exigentes.

### CORTADORA TECH

- ▶ Permite cortar hasta 1.250 mm y espesores de 20 mm.
- ▶ Construida con materiales de alta resistencia, sistema de montaje patentado y diseño optimizado para conseguir una máquina de gran precisión y duración.
- ▶ Incluye maleta trolley con ruedas, escuadra y rodel XL de 8, 10 o 18 mm en función de la máquina.

- ▶ Concebida para trabajar con grandes formatos.
- ▶ La mejor compañera para el instalador profesional con las necesidades más exigentes.

### CORTADORA PRO

- ▶ Permite cortar hasta 720 mm y espesores de 15 mm.
- ▶ Mecanismo separador monopunto ambidiestro integrado en el tope, progresivo y de alta potencia de rotura, liberando de esfuerzos al sistema de guiado. Incluye fundas para no marcar la cerámica. Base plana de fácil limpieza.
- ▶ Incluye maleta, escuadra y rodeles de 6 y 10 mm.

- ▶ Para altas intensidades de trabajo.

### CORTADORA FIT

- ▶ Permite cortes hasta 1.250 mm de longitud y 15 mm de espesor.
- ▶ Separador móvil magnético de fácil accionamiento, hasta 600 kg.
- ▶ Incluye conjunto regla-escuadra y rodel XL 8 mm.

- ▶ Para trabajos de alicatado en los que se busca la versatilidad.

### CORTADORA POP

- ▶ Permite cortes hasta 630 mm de longitud y 12 mm de espesor.
- ▶ Base de aluminio inyectado con perfil central nervado, extra ancha para garantizar la rigidez, estabilidad y precisión en el corte. Separador móvil hasta 300 kg. de fuerza.
- ▶ Incluye conjunto regla-escuadra y rodel 6 mm.

- ▶ Para corte de los formatos más habituales de baldosas y azulejos.

### CORTADORA PASS

- ▶ Hasta 610 mm de longitud y 12 mm de espesor.
- ▶ Separador móvil hasta 300 kg. de fuerza.
- ▶ Incluye tope escuadra-regla y rodel de 6 mm.

- ▶ Para trabajos de alicatado.

# ¿QUÉ QUIERES HACER?



	LEAN	NEO	TECH	PRO	FIT	POP	PASS
Espesor máximo de corte	12 mm	18 mm	20 mm	15 mm	15 mm	12 mm	12 mm
¿Para qué longitud de corte?	3.200 mm	1.550 mm	1.250 mm	720 mm	1.250 mm	630 mm	610 mm
¿Qué capacidad de rotura (Potencia separador) tienen?	200 kg	1.200 kg	1.000 kg	500 kg	600 kg	300 kg	300 kg
¿Qué rodel utilizo?	LEANRUL22	EVORUL22	8XL/10XL/18XL	6/8/10/18	8XL/10XL/18XL	6/8/10/18	6/8/10/18

## ELIGE TU RODEL



Ø 22

Utilízalo en pavimentos rústicos, gres y cerámica rugosa



Ø 6

Utilízalo en superficies liso brillante



Ø 8

Utilízalo en superficies liso mate



Ø 10

Utilízalo en superficies con texturizado mate



Ø 18

Utilízalo en superficies con texturizado rugosa

### ¿Sobre qué materiales?

Cerámica	▲	▲▲▲	▲▲	▲▲	
Porcelánico	▲▲	▲▲	▲▲▲	▲▲▲	▲▲
Gres Rústico	▲▲▲				▲▲▲
Gres	▲▲▲		▲▲	▲▲▲	▲▲▲
Mosaico de vidrio	▲▲▲	▲▲▲	▲▲		▲▲▲
Cerámica rugosa	▲▲▲		▲▲	▲▲▲	▲▲▲

## RENDIMIENTO DE RODELES & RODELES DE TITANIUM

¿Cuántos metros cortan?	Ø 22	Ø 6	Ø 8	Ø 10	Ø 18
Rodel normal	3.000 m	1.000 m	1.000 m	2.000 m	2.500 m
Rodel titanium	-	-	1.200 m	2.400 m	3.000 m

+20% RENDIMIENTO CON LOS RODELES DE TITANIUM

# CORTADORAS DE CERÁMICA Y ACCESORIOS

## CORTADORAS NEO

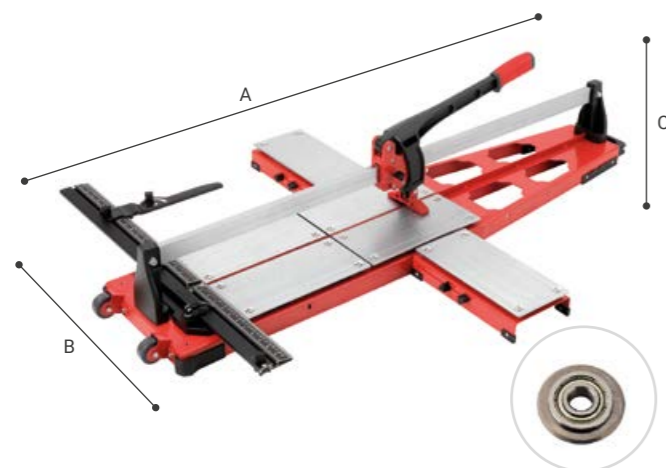
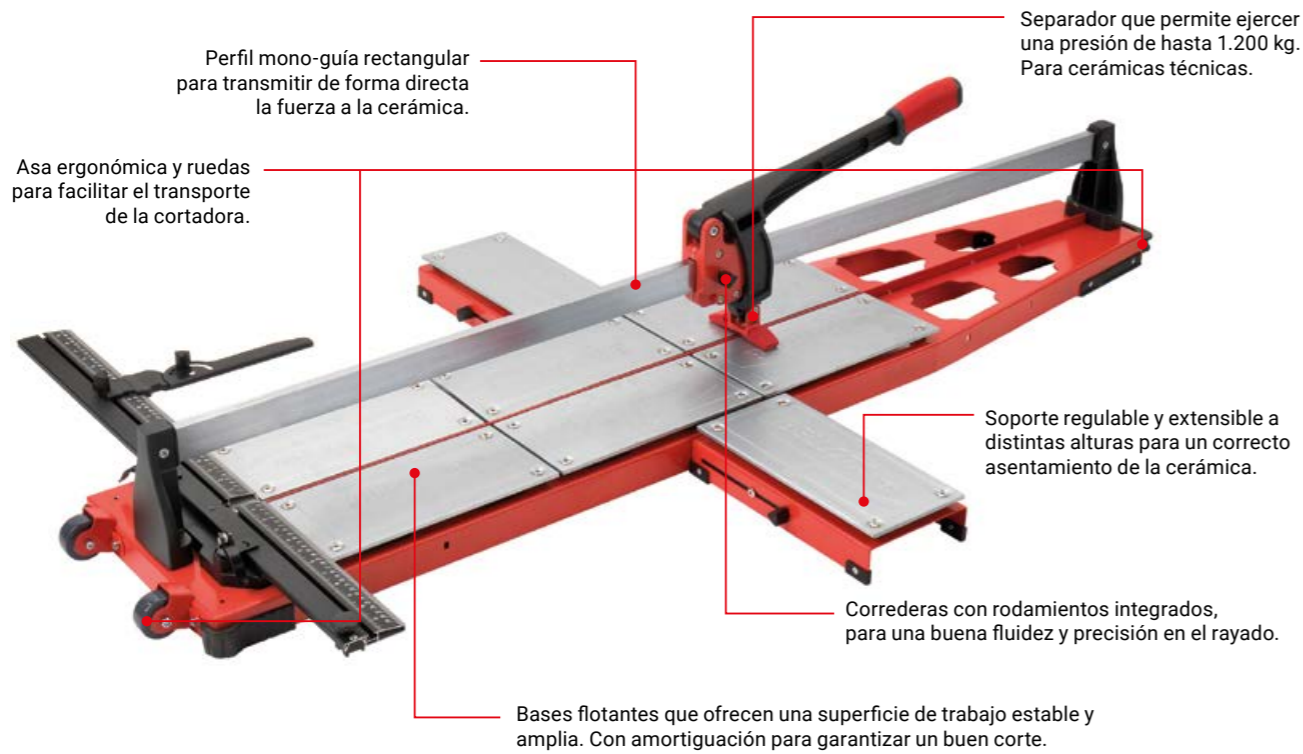

### ► CORTADORA CERÁMICA NEO

REF.	€	8 41 4299	g	A mm	B mm	C mm	X
NEO100	602,14	714876	1	30.000	1.280	300	300
NEO130	753,94	714883	1	34.500	1.530	300	300
NEO155	855,14	714890	1	38.000	1.780	300	300

Capacidad de corte por baldosa:

REF.	mm	mm
NEO100	1.000	18
NEO130	1.300	18
NEO155	1.550	18

Incluye Rulina de 22 mm y bolsa de transporte.



### ► BOLSA CORTADORA NEO

REF.	€	8 41 4299	g	A mm	B mm	C mm	X
CASENEO100	319,18	016567	1	4.500	1.320	360	300
CASENEO130	342,59	016581	1	5.500	1.570	360	300
CASENEO155	366,00	016611	1	7.000	1.820	360	300

## CORTADORAS LEAN



### ► CORTADORA CERÁMICA LEAN 320

REF.	€	8 41 4299	g	A mm	B mm	C mm	X
LEAN320	381,21	700275	1	9.500	1.220	160	160

Capacidad de corte por baldosa:

REF.	mm	mm
LEAN320	3.220	12

A partir de Marzo disponibles los accesorios para la manipulación y colocación de láminas de gran formato: mesa de trabajo, transportador y carro. LEANWB, LEANCART y LEANLIFT.

### ► BOLSA CORTADORA LEAN320

REF.	€	8 41 4299	g	A mm	B mm	C mm	X
BAGLEAN	39,04	700312	1	680	1.200	220	160





NEW

► ALICATE PLIERLEANF

REF.	€	8 41 4299	g	A mm	B mm	C mm
PLIERLEANF	19,95	051650	6	330	260	75 50



NEW

► TRANSPORTADOR LEAN

REF.	€	8 41 4299	g	A mm	B mm	C mm
LEANLIFT	1.669,75	019711	1	37.000	2.000	550 200



NEW

► MESA DE TRABAJO PARA LEANWB

REF.	€	8 41 4299	g	A mm	B mm	C mm
LEANWB	637,51	019728	1	29.000	1.850	290 200



NEW

► CARRO LEAN

REF.	€	8 41 4299	g	A mm	B mm	C mm
LEANCART	627,77	020496	1	26.000	1.560	330 185

## CORTADORAS TECH

**Correderas:**  
De polímero técnico extra-anchas que garantizan una máxima precisión y fluidez.

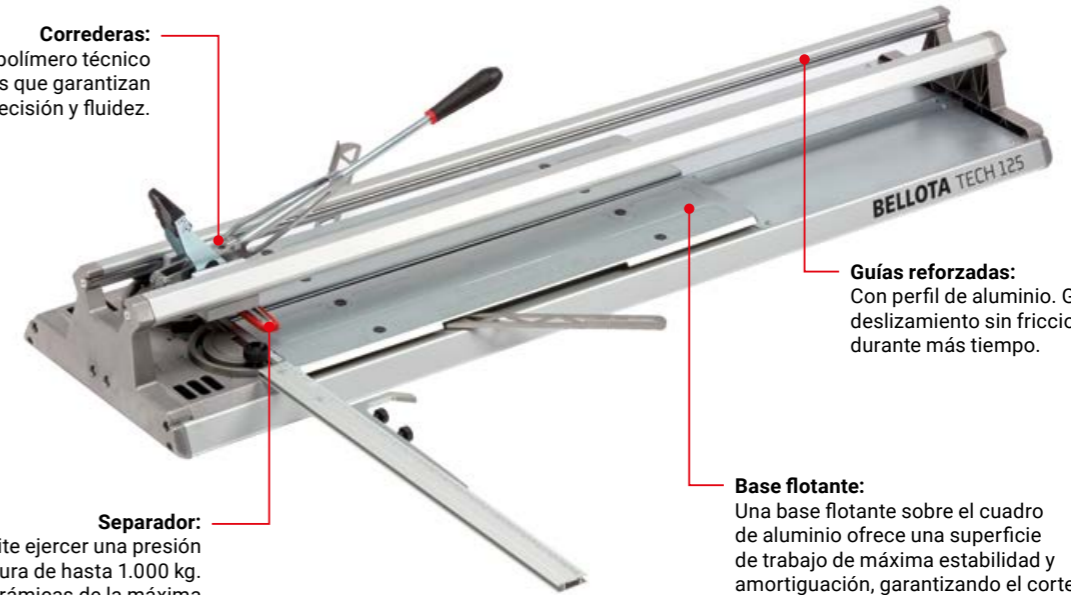

**Guías reforzadas:**  
Con perfil de aluminio. Garantizan un deslizamiento sin fricciones ni holguras durante más tiempo.

**Separador:**  
Permite ejercer una presión de rotura de hasta 1.000 kg. Para cerámicas de la máxima densidad.

**Base flotante:**  
Una base flotante sobre el cuadro de aluminio ofrece una superficie de trabajo de máxima estabilidad y amortiguación, garantizando el corte.



► CORTADORA DE CERÁMICA TECH

REF.	€	8 41 4299	g	A mm	B mm	C mm
TECH 100	763,62	634259	1	17.730	1.220	360 170 X
TECH 125	945,46	622065	1	20.240	1.470	360 170 X

► REPUESTO MALETA CON RUEDAS Y COMPARTIMIENTOS TECH

REF.	€	8 41 4299	g	A mm	B mm	C mm
TECH100CASE	273,93	641202	1	6.060	1.355	390 220
TECH125CASE	322,01	641226	1	7.010	1.600	410 220

Capacidad de corte por baldosa:

REF.	g	A mm	B mm	C mm
TECH100	1.000 mm	700 x 700 mm	20 mm	
TECH125	1.250 mm	880 x 880 mm	20 mm	

TECH75 incluye rodel XL 8 mm. TECH100 incluye rodel XL 10 mm. TECH125 incluye rodel XL 10 mm/XL 18 mm.

## CORTADORAS PRO

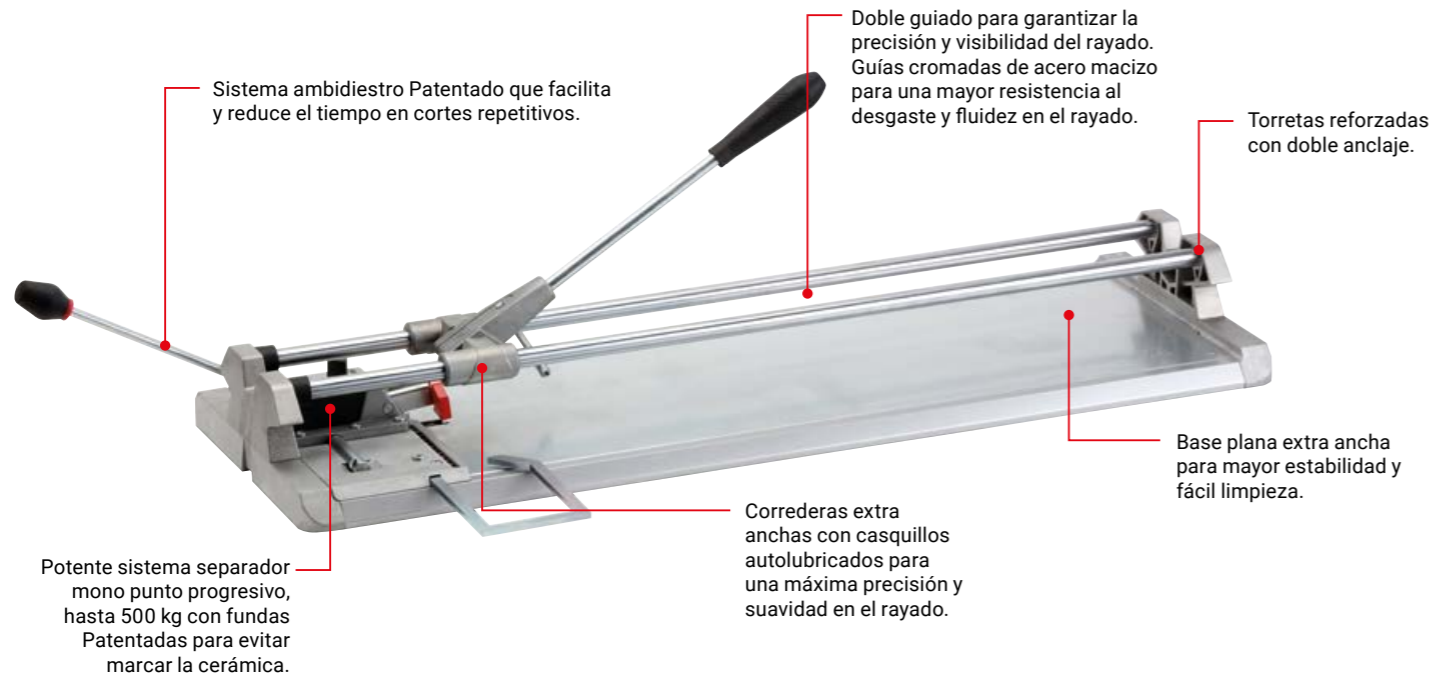

### CORTADORA DE CERÁMICA PRO 72

REF.	€	PROYECTO	g	A mm	B mm	C mm	
PRO 72	429,23	622041	1	11.650	905	327	100 X

Incluye rodel 6 mm y 10 mm.

Capacidad de corte por baldosa:

REF.			
PRO72	72 cm	50 x 50 cm	15 mm

### REPUESTO MALETA DE PLÁSTICO PRO

REF.	€	PROYECTO	g	A mm	B mm	C mm	
PROPCASE	132,44	636215	1	4.420	127	955	460

## CORTADORAS FIT



### CORTADORA CERÁMICA FIT

REF.	€	PROYECTO	g	A mm	B mm	C mm	
FIT80	243,22	686258	1	9.000	1.040	250	120 0
FIT100	304,33	686272	1	11.000	1.240	250	120 0
FIT120	379,50	716917	1	12.520	1.440	250	120 0

Capacidad de corte por baldosa:

REF.			
FIT80	850 mm	600 x 600 mm	15 mm
FIT100	1.050 mm	740 x 740 mm	15 mm
FIT120	1.250 mm	850 x 850 mm	15 mm

Incluye Rodel XL 8 mm y tope-esquadra para facilitar el corte.



### CORTADORA CERÁMICA FIT CON BOLSA

REF.	€	PROYECTO	g	A mm	B mm	C mm	
FIT80B	265,38	699043	1	9.665	1.040	250	120 X
FIT100B	327,11	699067	1	11.725	1.240	250	120 X
FIT120B	399,74	716924	1	13.320	1.440	250	120 X

Capacidad de corte por baldosa:

REF.			
FIT80B	850 mm	600 x 600 mm	15 mm
FIT100B	1.050 mm	740 x 740 mm	15 mm
FIT120B	1.250 mm	850 x 850 mm	15 mm

Incluye Rodel XL 8 mm y tope-esquadra para facilitar el corte.



### BOLSA CORTADORA FIT

REF.	€	PROYECTO	g	A mm	B mm	C mm	
BAGFIT80	24,10	699081	10	665	500	300	50
BAGFIT100	36,19	699111	10	725	500	300	70
BAGFIT120	40,75	716894	10	800	500	300	70

## CORTADORAS POP

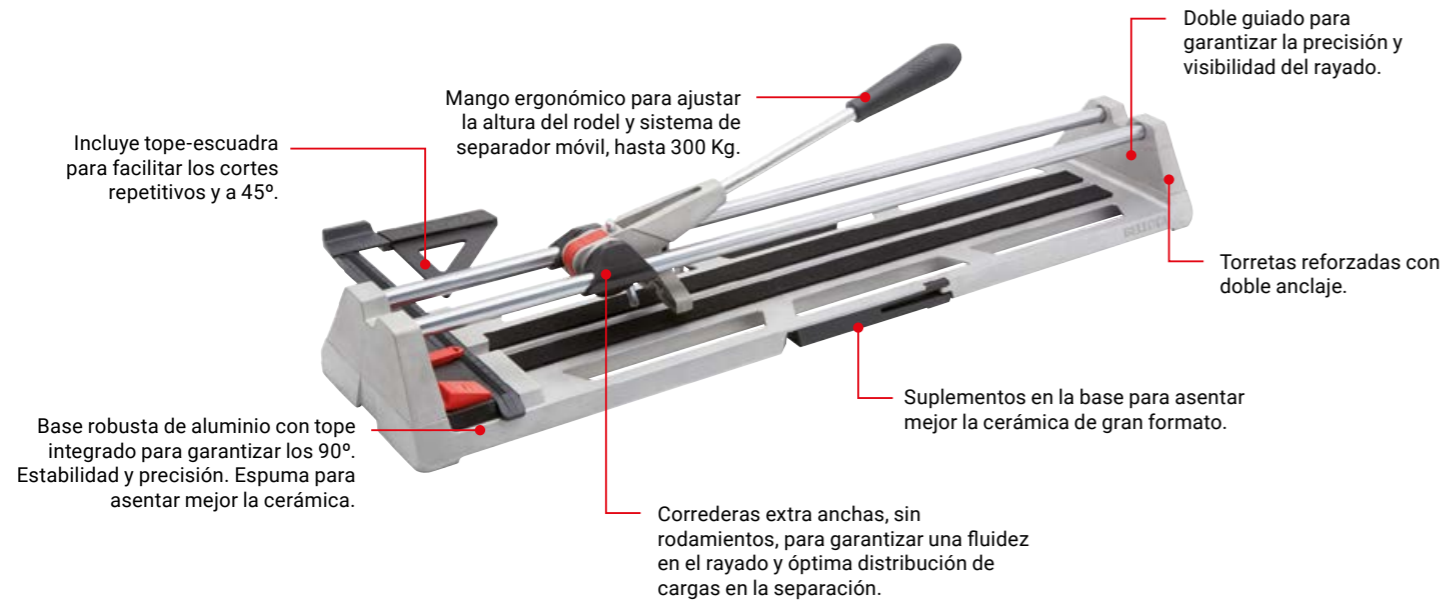

### ▶ CORTADORA DE CERÁMICA POP

REF.	€	8 41 4299	g	A mm	B mm	C mm	
POP 50-B	83,69	621969	1	4.180	695	175	85 X
POP 50-C	96,03	621976	1	4.160	695	175	95 X
POP 60-B	110,80	622355	1	4.620	795	175	95 X
POP 60-C	125,58	621990	1	4.620	795	175	95 X

REF.			
POP50-B	530 mm	380 x 380 mm	12 mm
POP50-C	530 mm	380 x 380 mm	12 mm
POP60-B	630 mm	450 x 450 mm	12 mm
POP60-C	630 mm	450 x 450 mm	12 mm

Torretas polímero plástico. Incluye rodel 6 mm. Incluye maleta rígida para POP 50-C y POP 60-C.



### ▶ MALETA DE PLÁSTICO POP POPCASE

REF.	€	8 41 4299	g	A mm	B mm	C mm	
POP60PCASE	53,64	636031	1	1.970	122	835	249

## CORTADORAS PASS

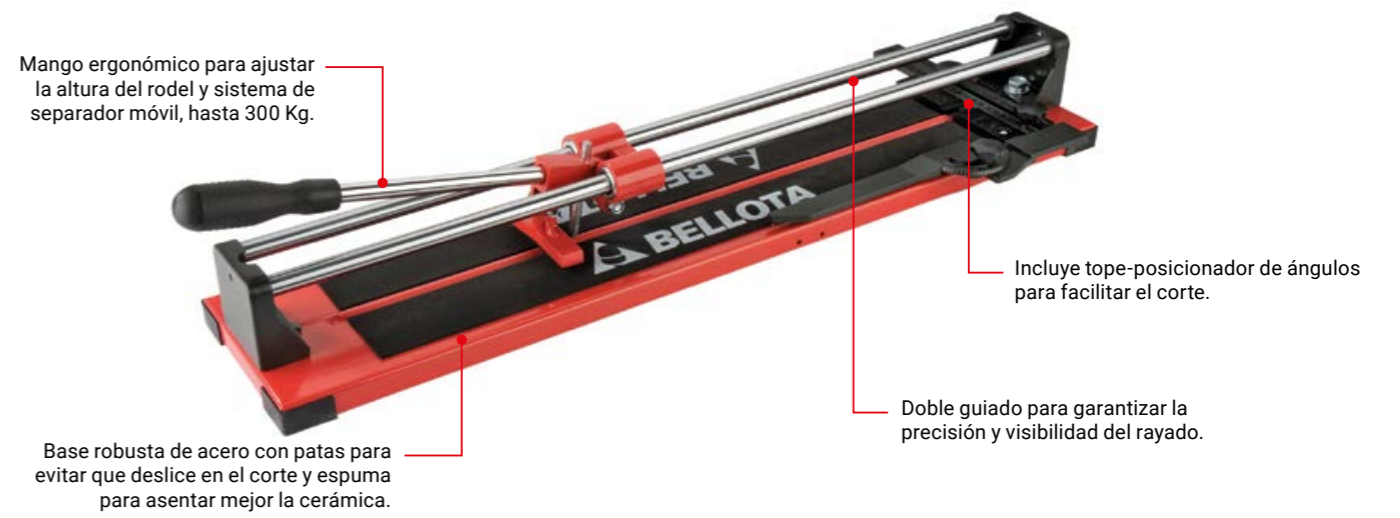

### ▶ CORTADORA CERÁMICA PASS 60

REF.	€	8 41 4299	g	A mm	B mm	C mm	
PASS 60	97,02	688801	1	7.500	800	170	110 0

REF.			
PASS60	610 mm	420 x 420 mm	12 mm

### ▶ CORTADORA DE CERÁMICA POP-R

REF.	€	8 41 4299	g	A mm	B mm	C mm	
POP 50-R-B	98,92	621983	1	4.380	695	175	95 X
POP 50-R-C	114,13	622003	1	4.340	695	175	95 X
POP 60-R-B	129,34	622010	1	4.830	795	175	95 X
POP 60-R-C	140,35	622027	1	4.840	795	176	95 X

REF.			
POP50-R-B	530 mm	380 x 380 mm	12 mm
POP50-R-C	530 mm	380 x 380 mm	12 mm
POP60-R-B	630 mm	450 x 450 mm	12 mm
POP60-R-C	630 mm	450 x 450 mm	12 mm

Torretas Aluminio. Incluye rodel 6mm y conjunto Regla-Escuadra. Incluye maleta rígida para POP 50-R-C y POP 60-R-C

\* POP50-R-B Y POP50-R-C HASTA FIN DE EXISTENCIAS

## RODELES

Precisión del corte, rulina de carburo de tungsteno de alta densidad, afilada, para una mayor vida útil.



Robustos, hechos de una sola pieza con Acero Especial Bellota. Versión XL para TECH y FIT.

Alto rendimiento, +25% metros rayados en versión estándar y +45% metros rayados en versión Titanio.

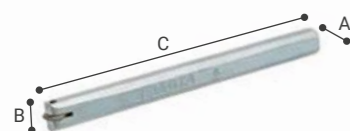

▶ RODEL 6

REF.	€	8 41 4299	g	A mm	B mm	C mm	
RODEL6	9,59	659276	10	30	5	6	83

Para uso en revestimientos de cerámica. Para POP y PRO.



▶ RODEL 8

REF.	€	8 41 4299	g	A mm	B mm	C mm	
RODEL8	10,95	659290	10	30	7	6	83,5

Para uso en gres porcelánico y cerámica. Para POP y PRO.



▶ RODEL 10

REF.	€	8 41 4299	g	A mm	B mm	C mm	
RODEL10	12,33	659320	10	30	9	9	84

Para uso en gres y gres porcelánico. Para POP y PRO.



▶ RODEL 18

REF.	€	8 41 4299	g	A mm	B mm	C mm	
RODEL18	24,14	659504	10	40	17	10	84

Para uso en pavimentos rústicos y revestimientos o pavimentos de corte difícil. Para POP y PRO.



▶ RODEL TITANIUM 8T

REF.	€	8 41 4299	g	A mm	B mm	C mm	
RODEL8T	14,15	659405	10	30	6	5	83,5

Para uso en gres porcelánico y cerámica. +20% vida útil. Para POP y PRO.



▶ RODEL TITANIUM 10T

REF.	€	8 41 4299	g	A mm	B mm	C mm	
RODEL10T	15,57	659467	10	30	10	9	84

Para uso en gres y gres porcelánico. +20% vida útil. Para POP y PRO.



▶ RODEL TITANIUM 18T

REF.	€	8 41 4299	g	A mm	B mm	C mm	
RODEL18T	26,98	659610	10	40	17	10	84

Para uso en pavimentos rústicos y revestimientos o pavimentos de corte difícil. +20% vida útil. Para PASS, POP y PRO.



▶ RODEL XL 8

REF.	€	8 41 4299	g	A mm	B mm	C mm	
RODELXL8	14,85	659597	10	40	7	6	100

Para uso en gres porcelánico y cerámica. Para TECH y FIT.



▶ RODEL XL 10

REF.	€	8 41 4299	g	A mm	B mm	C mm	
RODELXL10	16,29	659696	10	40	9	8	100

Para uso en gres y gres porcelánico. Para TECH y FIT.



▶ RODEL XL TITANIUM 8T

REF.	€	8 41 4299	g	A mm	B mm	C mm	
RODELXL8T	17,79	659658	10	40	7	6	100

Para uso en gres porcelánico y cerámica. +20% vida útil. Para TECH y FIT.



▶ RODEL XL TITANIUM 18T

REF.	€	8 41 4299	g	A mm	B mm	C mm	
RODELXL18T	30,63	659757	10	50	18	10	101

Para uso en pavimentos rústicos y revestimientos o pavimentos de corte difícil. +20% vida útil. Para TECH y FIT.



▶ RULINA 22 MM

REF.	€	8 41 4299	g	A mm	B mm	C mm	
EVORUL22	9,66	691597	1	48	22	4	



▶ RODEL XL 18

REF.	€	8 41 4299	g	A mm	B mm	C mm	
RODELXL18	27,76	659375	10	50	17	10	100

Para uso en pavimentos rústicos y revestimientos o pavimentos de corte difícil. Para TECH y FIT.



▶ RODEL XL TITANIUM 10T

REF.	€	8 41 4299	g	A mm	B mm	C mm	
RODELXL10T	19,21	659726	10	40	10	8	100

Para uso en gres y gres porcelánico. +20% vida útil. Para TECH y FIT.



▶ LEANRUL22

REF.	€	8 41 4299	g	A mm	B mm	C mm	
LEANRUL22	10,85	700329	1	48	150	40	5

Para LEAN y NEO.



▶ RODEL XL 6

REF.	€	8 41 4299	g	A mm	B mm	C mm	
RODXL6	13,95	039047	10	40	7	6	100

Para NEO.



▶ RODEL XL 8

REF.	€	8 41 4299	g	A mm	B mm	C mm	
RODXL8	14,85	021035	10	40	7	6	100

Para uso en gres porcelánico y cerámica. Para PASS y FIT120.



▶ RODEL XL 10

REF.	€	8 41 4299	g	A mm	B mm	C mm	
RODXL10	16,29	021134	10	40	9	8	100

Para uso en gres y gres porcelánico. Para PASS y FIT120.



▶ RODEL XL 18

REF.	€	8 41 4299	g	A mm	B mm	C mm	
RODXL18	27,76	021257	10	50	17	10	100

Para uso en pavimentos rústicos y revestimientos o pavimentos de corte difícil. Para PASS y FIT120.

# REPUESTOS CORTADORAS DE CERÁMICA

## CORTADORA NEO



### ► REPUESTOS CORTADORAS DE CERÁMICA NEO

REF.	€	PROYECTO 8 41 4299	Kg	A mm	B mm	C mm		
NEOBASEFLO	27,95	715521	1	0,353	300	140	10	NEO
NEOSUPPORTS	39,22	715507	1	1,228	310	190	65	NEO
NEOSLIDER	98,05	715583	1	0,982	450	70	190	NEO
NEOPITCHER	3,95	715569	1	0,066	113	24	50	NEO
NEORULER	27,54	715606	1	0,657	800	460	40	NEO
NEOHANDLE	9,95	715484	1	0,075	153	52	24	NEO
NEOWHEEL	11,68	715460	1	0,3	140	60	55	NEO

## CORTADORA LEAN



### ► REPUESTOS CORTADORAS DE CERÁMICA LEAN

REF.	€	PROYECTO 8 41 4299	Kg	A mm	B mm	C mm		
BREAKLEAN	34,98	700299	1	0,63	110	125	135	LEAN
GUIDELEAN	74,95	700282	1	1,58	20	90	1.118	LEAN
PLIERLEAN	10,36	700442	1	0,355	290	170	50	LEAN
SCRATLEAN	131,31	427738	1	0,53	100	83	90	LEAN
SUCLEAN	17,47	627985	1	0,57	50	120	145	LEAN

## CORTADORA TECH



### ► REPUESTOS CORTADORAS DE CERÁMICA TECH

REF.	€	PROYECTO 8 41 4299	Kg	A mm	B mm	C mm		
TECH BREAKERHAND	13,04	646665	1	0,071	100	50	35	TECH
TECHCLIPS	6,13	646702	1	0,065	140	80	40	TECH
TECHHANDLE	12,74	646740	1	0,42	460	35	35	TECH
TECHPADS	9,81	645743	1	0,016	110	60	30	TECH
TECHRULE	44,67	646788	1	0,68	900	130	25	TECH
TECHSCREWS	5,93	646825	1	0,52	50	70	70	TECH
TECHSLIDERS	203,69	645729	1	0,365	130	90	55	TECH
TECHSUPPORTS	15,40	646863	1	0,1	320	20	40	TECH

## CORTADORA PRO



### ► REPUESTOS CORTADORAS DE CERÁMICA PRO

REF.	€	PROYECTO 8 41 4299	Kg	A mm	B mm	C mm		
POPHANDLE	9,66	636093	20	0,33	345	32	32	PRO55/PRO72
PROSNAPHANDLE	9,66	636277	20	0,27	275	35	35	PRO55/PRO72
PROGUIDESQU	14,66	636314	30	0,3	385	97	6	PRO55/PRO72
PROGUIDESCR	6,47	636352	20	0,03	30	20	20	PRO55/PRO72
PROJAWCOVERS	3,67	636390	20	0,02	25	28	7	PRO55/PRO72
PROBROKMECH	162,15	636437	1	1,15	260	150	80	PRO55/PRO72

## CORTADORA FIT



### ► REPUESTOS CORTADORAS DE CERÁMICA FIT

REF.	€	PROYECTO 8 41 4299	Kg	A mm	B mm	C mm		
FITHANDLE	8,85	689365	1	0,485	375	30	30	FIT
FITPITCHER	3,40	689440	1	0,048	130	15	40	FIT
FITRKIT	8,58	691528	1	0,166	400	150	15	FIT
FITSUPPORTS	7,54	689372	1	0,48	340	100	35	FIT
FITFOAM	15,28	707045	1	0,06	1060	80	20	FIT

## CORTADORA POP



### ► REPUESTOS CORTADORAS DE CERÁMICA POP

REF.	€	PROYECTO 8 41 4299	Kg	A mm	B mm	C mm		
POPHANDLE	9,66	636093	1	0,33	345	32	32	POP
POPPITCHER	7,08	636130	1	0,05	70	15	50	POP
POPRKIT	10,00	636178	1	0,3	320	160	40	POP

## CORTADORA PASS



### ► REPUESTOS CORTADORAS DE CERÁMICA PASS

REF.	€	PROYECTO 8 41 4299	Kg	A mm	B mm	C mm		
PASSHANDLE	7,54	691559	1	0,435	325	30	30	PASS
PASSPITCHER	7,54	691535	1	0,05	90	20	45	PASS
PASSFOAM	6,53	707069	1	0,3	600	60	6	PASS
PASSRKIT	5,99	691542	1	0,24	280	130	30	PASS

# NIVELADORES

## ¿CUÁNTOS CALZOS NECESITAS?

### PARA CALZO ESTÁNDAR

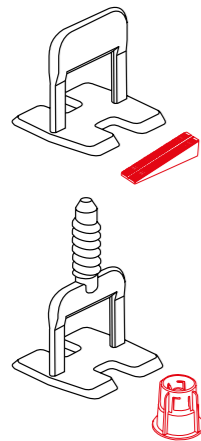

A	10	15	20	25	30	35	40	45	50	55	60	65	70	80	90	100	110	120	B
10	200																		
15	133	89																	
20	100	67	50																
25	80	53	40	32															
30	100	44	40	33	33														
35	100	67	50	40	29	28													
40	100	67	50	40	33	29	25												
45	89	59	44	36	30	25	22	20											
50	80	53	40	32	27	23	20	18	16										
55	73	48	36	29	24	21	18	16	15	13									
60	75	50	37	30	22	21	17	15	15	14	11								
65	69	46	35	28	23	20	17	15	14	13	12	11							
70	71	48	36	29	24	20	18	16	14	13	12	11	10						
80	69	46	34	28	23	20	16	14	14	12	10	10	10	9					
90	61	41	31	24	19	17	15	14	12	11	10	9	9	8	7				
100	60	40	30	24	20	17	15	13	12	11	10	9	9	9	8	8			
110	59	39	30	24	20	17	15	13	12	11	10	9	8	7	7	6			
120	54	36	27	22	18	15	14	12	10	10	8	8	8	7	7	6	6		

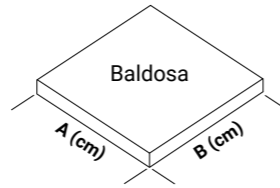

### PARA CALZO EN CRUZ

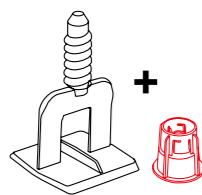

A	120	100	90	80	60	50	45	40	B
120					5	4	4	3	4
100					6	5	5	5	
90	10							4	
80		8	7		5	5			
60	11	9	8		6				
50				8					
45					10				
40						13			

## ¿CÓMO ROMPER?

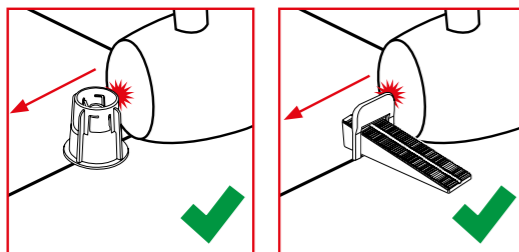

## ¿CÓMO NO ROMPER?

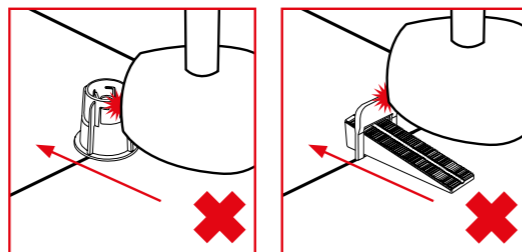

# SISTEMAS DE NIVELACIÓN Y SEPARACIÓN

## SISTEMA PUSH & LEVEL

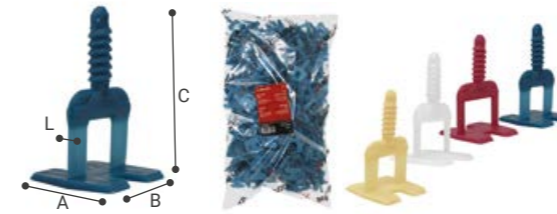

### CALZO PUSH

REF.	€	g	A mm	B mm	C mm	L mm	Uni. Box	Uni. Pack
LSS005	24,02	672954	1	880	70	260	450	0,5 200 2.000
LSS010	24,02	672992	1	880	70	260	450	1 200 2.000
LSS020	24,02	673036	1	880	70	260	450	2 200 2.000
LSS030	24,02	673074	1	880	70	260	450	3 200 2.000
LSS015	24,02	707908	1	880	70	260	450	1,5 200 2.000



NEW

### CALZO DE 1 MM PARA CERÁMICA DE 20 MM

REF.	€	g	A mm	B mm	C mm	L mm	Uni. Box	Uni. Pack
LSS010S	28,34	673111	1	892	70	260	450	1 200 2.000
LSS040S	28,34	706239	1	932	70	260	450	4 1 10
LSS050S	28,34	706253	1	975	70	260	450	5 1 10
LSS030S	28,34	706550	1	963	70	260	450	3 1 10
LSS020S	28,34	673630	1	927	80	460	260	2 200 2.000

Para baldosas hasta 20 mm de espesor.



### CALZO PUSH EN CRUZ

REF.	€	g	A mm	B mm	C mm	L mm	Uni. Box	Uni. Pack
LSS010CROSS	24,02	673142	1	970	70	260	450	1 200 2.000
LSS020CROSS	24,02	650877	1	970	70	260	450	2 200 2.000
LSS030CROSS	24,02	682090	1	970	70	260	450	3 200 2.000



REF.	€	g	A mm	B mm	C mm	L mm	Uni. Box	Uni. Pack
LSS010T	24,02	673173	1	880	70	260	450	1 200 2.000
LSS020T	24,02	682175	1	880	70	260	450	2 200 2.000
LSS030T	24,02	682250	1	880	70	260	450	3 200 2.000

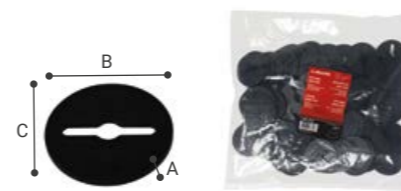

### BASE

REF.	€	g	A mm	B mm	C mm	Uni. Box	Uni. Pack	
LSPLATE	10,80	673586	1	540	30	260	310	100 2.500

Para baldosas finas de hasta 3 mm.



### ROSCA DE NIVELACIÓN

REF.	€	g	A mm	B mm	C mm	Uni. Box	Uni. Pack	
LSSCREW	67,24	673210	1	1.130	100	260	530	100 500



### KIT PUSH & LEVEL

REF.	€	g	A mm	B mm	C mm	L mm	Uni. Box	Uni. Pack
LSSKIT010	49,53	672916	1	1.950	280	280	200	1 100 100
LSSKIT020	49,53	672930	1	1.930	280	280	200	2 100 100
LSSKIT030	49,53	686982	1	1.940	280	280	200	3 100 100

100 calzos y 50 push

## SISTEMA CON CUÑA



▶ CUÑA

REF.	€	8 41 4299	g	A mm	B mm	C mm	
LSWEDGE	24,67	673517	1	1.860	70	260	500



▶ ALICATE METÁLICO

REF.	€	8 41 4299	g	A mm	B mm	C mm	Uni. Box	Uni. Pack	
LSPLIER	23,63	673296	1	360	50	170	290	1	10



▶ CALZO CUÑA

REF.	€	8 41 4299	g	A mm	B mm	C mm	L mm	Uni. Box	Uni. Pack	
LSW005	23,63	673319	1	890	70	260	450	0,5	250	2.500
LSW010	23,63	673357	1	950	70	260	450	1	250	2.500
LSW015	23,63	673371	1	990	70	260	450	1,5	250	2.500
LSW020	23,63	673418	1	980	70	260	450	2	250	2.500
LSW0202000	188,89	675436	1	7.900	470	370	365	2	2000	2.000
LSW030	24,67	673449	1	1.040	70	260	450	3	250	2.500
LSW0302000	197,18	675474	1	8.300	470	370	365	3	2000	2.000
LSW0152000	188,89	700268	1	7.800	470	370	365	1,5	2000	2.000



▶ CALZO CUÑA 1 MM

REF.	€	8 41 4299	g	A mm	B mm	C mm	L mm	Uni. Box	Uni. Pack	
LSW010S	26,92	673470	1	1.153	70	260	500	1	250	2.500
LSW030S	26,92	453584	1	1.175	70	260	500	3		
LSW040S	26,92	453690	1	1.234	70	260	500	4		
LSW050S	26,92	453799	1	1.433	70	260	500	5		
LSW020S	26,92	673616	1	1.162	80	460	260	2	250	2.500

Para baldosas hasta 20 mm de espesor.



▶ KIT CUÑA

REF.	€	8 41 4299	g	A mm	B mm	C mm	L mm	Uni. Box	Uni. Pack	
LSWKIT010	48,38	673258	1	2.020	280	280	200	1	100	100
LSWKIT020	48,38	673272	1	2.030	280	280	200	2	100	100
LSWKIT030	48,38	686999	1	2.160	280	280	200	3	100	100

100 calzos, 100 cuñas y 1 alicate.

## CRUCETAS

- Fabricadas con material plástico puros de alta calidad, sin impurezas. Calidad homogénea, sin rebabas.
- Escuadradas perfectamente a 90°: máxima precisión asegurando un excelente acabado de las juntas.
- Estructura reforzada: máxima resistencia y robustez.
- Gran rigidez, tanto horizontal como vertical. No se deforman.

### Usos:

- Para la perfecta formación de las juntas en la colocación de piezas cerámicas, tanto en revestimiento como en pavimentos.



▶ CRUCETA 1MM

REF.	€	8 41 4299	g	A mm	B mm	C mm	L mm	Uni. Box	Uni. Pack	
SPC010	1,93	672466	1	70	180	190	30	1	200	10.000
SPC020	1,93	672510	1	100	230	190	30	2	200	10.000
SPC030	2,71	672558	1	150	230	190	30	3	200	10.000
SPC050	2,95	672596	1	240	280	190	30	5	200	10.000
SPC070	3,29	672633	1	340	330	190	30	7	200	10.000
SPC100	4,77	672671	1	50	360	170	40	10	200	10.000
SPC015	1,93	686319	1	850	200	190	30	1,5	200	20.000
SPC0101000	9,27	695434	1	40	30	180	190	1	1000	20.000
SPC0151000	9,27	695458	1	70	20	230	190	1,5	1000	20.000
SPC0201000	8,88	695472	1	70	20	230	190	2	1000	20.000
SPC030500	5,21	700893	1	120	30	190	230	3	500	20.000



▶ CRUCETA T 1MM

REF.	€	8 41 4299	g	A mm	B mm	C mm	L mm	Uni. Box	Uni. Pack	
SPC010T	2,00	672718	1	50	180	190	20	1	200	10.000
SPC020T	2,00	672756	1	70	180	190	20	2	200	10.000
SPC030T	2,84	672794	1	90	180	190	20	3	200	10.000

## CUÑAS



▶ CUÑA DE 6 MM

REF.	€	8 41 4299	g	A mm	B mm	C mm	L mm	Uni. Box	Uni. Pack	
SPCWEDGE	2,59	672879	1	140	180	190	30	5	200	10.000

# COMPLEMENTOS PARA EL ALICATADO

## CUBOS DE ALICATADO Y REPUESTOS

- Cubeta de plástico de alta resistencia. Capacidad máxima 20 litros.
- Con 3 rodillos escurridores y rejilla en la base: alta capacidad de escurrido.
- Base con pendiente para el decantado de los residuos generados por la limpieza.
- Facilidad de uso y transporte. Incorpora ruedas y asa.

### Usos:

- Para trabajos de limpieza en alicatado.



► CUBO PROFESIONAL ALICATADO 5800

REF.	€	8 41 4299	g	A mm	B mm	C mm
5800-3	45,90	631081	1	1.820	515	265
5800-3 BP	41,32	631104	8	1.830	520	270

BP se sirve en caja cartón Box-Palet expositora.



► KIT CUBO ALICATADO

REF.	€	8 41 4299	g	A mm	B mm	C mm
5800-3KIT	73,45	623215	1	2.400	560	290

Incluye: Ref 5800, Ref 5898B, Ref 5888 y Ref CS121875.



► KIT DE RUEDAS Y PATAS PARA CUBO ALICATADO

REF.	€	8 41 4299	g	A mm	B mm	C mm
58003RW	4,62	656039	1	40	100	50



► SET 3 RODILLOS PARA CUBO ALICATADO

REF.	€	8 41 4299	g	A mm	B mm	C mm
58003RRD	31,95	656046	6	310	270	140

## ESPONJAS

- Fabricadas en materiales de alta calidad.
- Máxima capacidad de absorción de agua.
- Alta capacidad de lavado y arrastre de la suciedad.
- Muy resistentes y duraderas.
- La gama EXTRA ABSORBENTE de cortes longitudinales permite una mayor absorción y arrastre de la suciedad.

### Usos:

- Para trabajos de limpieza. Uso profesional.



► ESPONJA SIMPLE CS12187S

REF.	€	8 41 4299	g	A mm	B mm	C mm
CS12187S	1,99	632095	25	30	180	70

Capacidad de absorción y resistencia media.



► ESPONJA MIXTA CS12187MX

REF.	€	8 41 4299	g	A mm	B mm	C mm
CS12187MX	3,27	632132	25	40	180	70

Capacidad de absorción media y resistencia alta. Capa abrasiva de poliéster para mejor limpieza.



► ESPONJA CLOUD CSW12187

REF.	€	8 41 4299	g	A mm	B mm	C mm
CSW12187	3,39	632170	25	50	180	70

Capacidad de absorción y resistencia alta. Humedad duradera, mayor facilidad de trabajo.



► ESPONJA CLOUD EXTRA ABSORBENTE CSW12187E

REF.	€	8 41 4299	g	A mm	B mm	C mm
CSW12187E	4,09	632194	25	50	120	180

Capacidad de absorción y resistencia alta. Humedad duradera, mayor facilidad de trabajo. Cortes longitudinales para una mayor absorción y arrastre de la suciedad. \*HASTA FIN DE EXISTENCIAS.



► ESPONJA CELULOSA CS10174C

REF.	€	8 41 4299	g	A mm	B mm	C mm
CS10174C	7,08	639469	6	50	175	95

Capacidad de absorción y resistencia muy alta.

## VENTOSAS

- Ventosas con cuerpo de plástico: capacidad de sujeción de 40 kg. (simple) y 70 kg. (doble), con goma Blanca para evitar marcar las piezas. Para acabados superficiales lisos.
- Ventosas con cuerpo de aluminio: capacidad de sujeción de 40 kg. (simple), 70 kg. (doble) y 100 kg. (triple), con goma Blanca para evitar marcar las piezas. Para acabados superficiales lisos.
- Ventosa con bomba vacío: capacidad de sujeción de 120kg, con goma negra estriada para acabados superficiales rugosos, dispone de indicador de vacío, válvula de liberación manual y maleta para garantizar el transporte. Para la manipulación de materiales pesados o baldosas de gran formato sin importar el acabado superficial.

### Usos:

- Multifuncionales. Para la manipulación de materiales pesados, baldosas cerámicas de mediano o gran formato, hojas de vidrio...

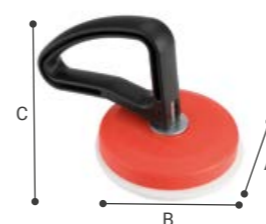

► VENTOSA CUERPO PLÁSTICO

REF.	€	8 41 4299	g	A mm	B mm	C mm
SUCP40SP	13,82	704945	1	252	120	120
SUCP70SP	26,61	704969	1	470	320	120



► VENTOSA CUERPO ALUMINIO

REF.	€	8 41 4299	g	A mm	B mm	C mm
SUCA40SP	17,01	699425	1	420	120	120
SUCA70SP	35,14	699449	1	791	320	120
SUCA100SP	50,06	699463	1	1.126	320	225



► VENTOSA BOMBA VACÍO SUCR100RBPN

REF.	€	8 41 4299	g	A mm	B mm	C mm
SUCR100RBPN	74,95	039856	1	1.510	235	110

NEW



► ESPUMA ADHESIVA DE 120MM SUCPAD

REF.	€	8 41 4299	g	A mm	B mm	C mm
SUCPAD	7,49	042740	1	31	120	120

NEW



## BANCO DE TRABAJO

- Banco de trabajo resistente y estable con patas y estructura de acero. Soporta hasta un máximo de 450kg.
- Mesa de 940 mm de largo por 480 mm de ancho, con bandeja para herramientas, clasificadores, regla y transportador y almacenaje, con asa para que vaya siempre contigo y plegable para que ocupe el mínimo.

### Usos:

- Multinacional, para todo lo que precises: Andamio, Caballete o Banco de trabajo, regulable en 3 alturas (520mm, 660mm y 800mm).



### BANCO DE TRABAJO PLEGABLE Y REGULABLE A 3 ALTURAS FWB01

REF.	€	8 41 4299	g	A mm	B mm	C mm	
FWB01	158,99	700466	1	12.000	105	480	940

Como banco de trabajo, caballete o andamio a distintas alturas. Robusto, versátil y práctico.

## APLANADOR SOLADOR



### APLANADOR DE GOMA 8056

REF.	€	8 41 4299	g	A mm	B mm	C mm	
8056	26,95	051926	6	2.337	355	146	78,5

NEW

## PLANTILLA DE FORMAS



### MARCADOR PARA AGUJEROS DE 1040 MM

REF.	€	8 41 4299	g	A mm	B mm	C mm	
MAGUJEROS	19,95	051414	12	221	175	120	30

NEW

## MARCADOR DE AGUJEROS



### PLANTILLA PARA FORMAS DE 260 MM

REF.	€	8 41 4299	g	A mm	B mm	C mm	
PFORMAS	19,95	049114	12	486	132	318	21

NEW

## RASCADOR DE JUNTAS



### HOJAS PARA EL RASCADOR RJUNTASR

REF.	€	8 41 4299	g	A mm	B mm	C mm	
RJUNTASR	3,45	048872	20	14	50,5	1	19,5

NEW



### RASCADOR DE JUNTAS

REF.	€	8 41 4299	g	A mm	B mm	C mm	
RJUNTAS	6,95	048827	6	115	191	27	62

NEW

# SIERRAS Y SERRUCHOS DE CONSTRUCCIÓN

## SIERRAS CORTE METAL

- Arcos de diseño optimizado para conseguir una gran capacidad de corte y una mayor comodidad de trabajo.
- Incorpora un mecanismo tensionador de la hoja.
- Incorpora sistema de cambio rápido de la hoja.
- Incluye una hoja ref. 4604-12.24 de 24 dientes.
- Tres posibilidades de hojas de acero de máxima calidad de 18 dientes (acabado medio) o 24 dientes (acabado fino).
  - Hoja flexible bimetal HSS: filo de acero rápido M2, para uso profesional.
  - Hoja rígida HSS de acero rápido M2. Para uso profesional, especialmente recomendado para trabajos mecánicos y de matricería.
  - Hoja flexible de acero aleado, para corte de aceros blandos, metales no férricos y plásticos.
- Mangos ergonómicos para un trabajo mas cómodo.

### Usos:

- Para corte de perfilaría, acero, aluminio, inoxidable, pvc, etc. y trabajos varios de corte

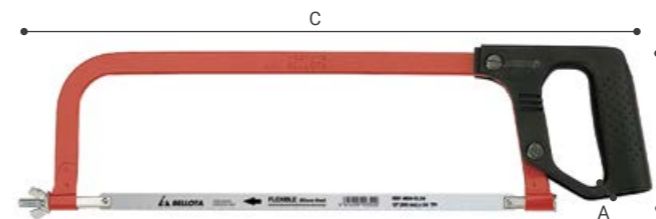

### SIERRA DE ARCO 4621

REF.	€	8 41 4299	g	A mm	B mm	C mm	
4621-12	14,24	404869	12	520	23	126	469

Pletina maciza de 5 mm. Profesional.



### SIERRA DE ARCO ALUMINIO 4630

REF.	€	8 41 4299	g	A mm	B mm	C mm	
4630-12	25,29	404883	6	560	22	153	387

Aluminio. Resistente y ligero.



### HOJA BIMETAL HSS 4601

REF.	€	8 41 4299	g	A mm	B mm	C mm	
4601-12.18	2,47	923445	100	20	1	13	311
4601-12.24	2,47	405026	100	20	1	12	311



### HOJA BIMETAL HSS 4601

REF.	€	8 41 4299	g	A mm	B mm	C mm	
4601-12.24 BS	6,69	206074	12	40	1	40	378



### HOJA RÍGIDA HSS 4602

REF.	€	8 41 4299	g	A mm	B mm	C mm	
4602-12.18	2,36	923483	100	20	1	13	312
4602-12.24	2,29	406177	100	20	1	13	311



### HOJA RÍGIDA HSS 4602

REF.	€	8 41 4299	g	A mm	B mm	C mm	
4602-12.24 BS	6,31	206166	12	40	1	40	378



### HOJA FLEXIBLE 4604

REF.	€	8 41 4299	g	A mm	B mm	C mm	
4604-12.18	1,15	923520	100	20	1	13	308
4604-12.24	1,12	405118	100	20	1	13	312



### HOJA FLEXIBLE 4604

REF.	€	8 41 4299	g	A mm	B mm	C mm	
4604-12.18	1,15	923520	100	20	1	13	308
4604-12.24	1,12	405118	100	20	1	13	312

## SERRUCHOS CARPINTERO

- Fabricados con Acero Especial Bellota.
- Dentado japonés afilado por tres caras para mayor facilidad y limpieza de corte.
- Doble tratamiento térmico para conseguir un mayor rendimiento: temple integral en la hoja y temple extra-duro en los dientes.
- Mango diseñado para transmitir la máxima fuerza a lo largo de todo el dentado.
- Dos tipos de mangos:
  - Mangos de madera barnizados, ligeros y de tacto agradable.
  - Mangos bimateriales ergonómicos con acabado SOFT TOUCH para mayor comodidad durante el trabajo.

### Usos:

- Para corte de madera, aglomerado, yeso, plástico y otros materiales.

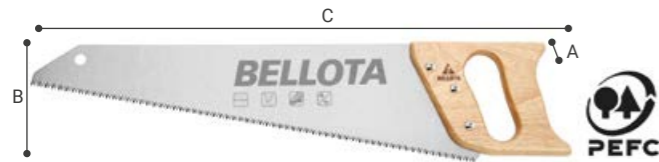

#### ► SERRUCHO CARPINTERO 4551

REF.	€	8 41 4299	g	A mm	B mm	C mm	L mm
4551-14	27,80	300901	6	410	25	130	345
4551-16	29,72	301007	6	420	25	130	505
4551-19	34,10	360899	6	490	25	140	580
4551-22	37,84	301304	6	510	25	140	660



#### ► SERRUCHO CARPINTERO MANGO BIMATERIAL 4555

REF.	€	8 41 4299	g	A mm	B mm	C mm	L mm
4555-14	23,50	313611	6	450	35	135	345
4555-16	24,82	313628	6	450	35	135	515
4555-19	28,52	447194	6	540	35	140	585
4555-22	32,13	313659	6	560	35	145	670



#### ► SERRUCHO COSTILLA 4561

REF.	€	8 41 4299	g	A mm	B mm	C mm	L mm
4561-12	36,36	302707	6	480	24,9	150	400
4561-14	38,88	302806	6	550	25	150	450

Nervio en la zona superior de la hoja que garantiza rigidez durante el corte.



#### ► SERRUCHO COSTILLA MANGO BIMATERIAL 4565

REF.	€	8 41 4299	g	A mm	B mm	C mm	L mm
4565-12	32,43	313734	6	530	35	150	410
4565-14	34,97	313741	6	580	35	150	460

Nervio en la zona superior de la hoja que garantiza rigidez durante el corte.

## SERRUCHOS EBANISTA



#### ► SERRUCHO EBANISTA 4568-S

REF.	€	8 41 4299	g	A mm	B mm	C mm	L mm
4568-S	16,38	623345	6	190	30	66	250



#### ► SERRUCHO EBANISTA 4568-L

REF.	€	8 41 4299	g	A mm	B mm	C mm	L mm
4568-L	16,38	624328	6	220	49	71	375

Mango angulado que permite el corte en bisel.\* DISPONIBILIDAD HASTA FIN DE EXISTENCIAS.

## SERRUCHOS PUNTA



#### ► SERRUCHO PUNTA 4572

REF.	€	8 41 4299	g	A mm	B mm	C mm	L mm
4572-10	19,59	303001	6	170	20	105	265
4572-12	19,95	303100	6	190	25	105	455

Uso en zonas de difícil acceso.



#### ► SERRUCHO DE PUNTA 4521

REF.	€	8 41 4299	g	A mm	B mm	C mm	L mm
4521	22,70	199093	6	138	27	55	310

Punta afilada y grosor de hoja 1,8 mm. Especial para corte de yeso laminado.

## SERRUCHOS PLACA



#### ► SERRUCHO PLACA 4520

REF.	€	8 41 4299	g	A mm	B mm	C mm	L mm
4520-15	31,28	561449	6	440	35	150	478

Extremo de la hoja en punta que facilita el corte en encuentros techo-paredes.

## FORMONES

### FORMÓN

- Hoja de Acero Cromo-Vanadio reafilable en toda su longitud. Perfectamente rectificadas y torneadas.
- Tratamiento térmico de precisión en la hoja: máxima duración y resistencia al desgaste.
- Sección cuadrada de la espiga para evitar la rotación del mango.
- Enmangado mediante prensa neumática para asegurar perfecta unión entre hoja y espiga.
- Hojas barnizadas para proteger de la oxidación.
- Dos tipos de mangos:
  - Mangos de madera barnizados, ligeros y de tacto agradable.

### Usos:

Para trabajos de talla, ajustes y acabados varios sobre madera.

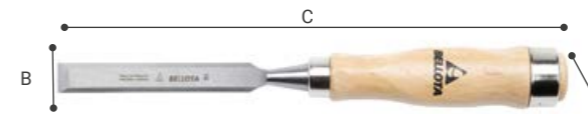

#### ► FORMÓN 4651

REF.	€	8 41 4299	g	A mm	B mm	C mm	L mm
4651-4	14,60	417234	6	120	28	32	262
4651-6	14,71	417272	6	120	28	32	262
4651-8	15,03	415032	6	130	28	32	264
4651-10	15,47	417357	6	140	28	32	266
4651-12	16,07	417449	6	490	28	32	268
4651-14	16,60	417487	6	150	28	32	270
4651-16	16,81	417524	6	160	28	32	272
4651-18	17,34	417562	6	160	28	32	274
4651-20	18,07	417609	6	180	28	32	276
4651-22	19,07	417647	6	180	28	32	278
4651-24	20,07	417685	6	180	28	32	280
4651-26	20,96	417722	6	180	28	32	282
4651-28	21,54	417760	6	200	28	32	284
4651-30	22,14	417807	6	210	28	32	286
4651-32	23,62	417845	6	210	28	32	288



#### ► KIT FORMONES MANGO MADERA 8910

REF.	€	8 41 4299	g	A mm	B mm	C mm	L mm
8910	125,76	429879	4	302	43	335	232 6;10;16;20;26

Contiene Ref.: 4651-6, 4651-10, 4651-16, 4651-20, 4651-26.

# HERRAMIENTAS DE CORTE

## CUTTERS

- Cuchillas de acero al carbono de alta calidad tratadas térmicamente: máxima duración y vida útil.
- Cambio rápido de la hoja, sin necesidad de abrir el cutter.
- Posibilidad de bloqueo de la punta mediante rueda: ref. 51404 y 51406.
- Guías de acero inoxidable que garantizan un perfecto deslizamiento de la cuchilla.
- Muy ergonómicos, cómodos y fáciles de usar.

### Usos:

- Para corte de todo tipo de materiales de forma continuada.
- Especialmente recomendados para el corte de placa de yeso laminado y lana de roca.

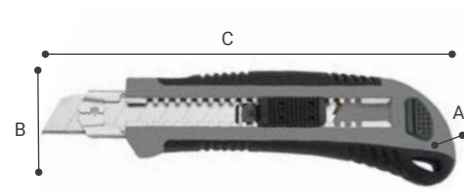

▶ CUTTER BIMATERIAL 51404

REF.	€	8 41 4299	g	A mm	B mm	C mm	L mm
51404-18	9,68	561487	12	160	25	172	18

Incluye 5 cuchillas.



▶ HOJA PARA CUTTER BIMATERIAL 51404

REF.	€	8 41 4299	g	A mm	B mm	C mm	L mm
H51404-18	4,42	561593	10	10	0,5	18	110

Se presentan en blister 10 cuchillas.



▶ CUTTER BIMATERIAL 51405

REF.	€	8 41 4299	g	A mm	B mm	C mm	L mm
51405-25	10,61	561531	12	110	21	188	25

Incluye 1 cuchilla de 25 mm.



▶ HOJA PARA CUTTER BIMATERIAL 51405

REF.	€	8 41 4299	g	A mm	B mm	C mm	L mm
H51405-25	5,86	561630	10	20	0,7	25	137

Se presentan en blister 10 cuchillas.



▶ CUTTER BIMATERIAL TITANIUM 51406

REF.	€	8 41 4299	g	A mm	B mm	C mm	L mm
51406-18	16,59	561555	12	160	25	48	169

Incluye 6 cuchillas de 18 mm. Duración 8 veces superior al resto de cuchillas.



▶ HOJA PARA CUTTER BIMATERIAL TITANIUM 51406

REF.	€	8 41 4299	g	A mm	B mm	C mm	L mm
H51406-18	6,48	561654	10	10	0,5	18	110

Se presentan en blister 10 cuchillas.



▶ CUTTER METÁLICO 51407

REF.	€	8 41 4299	g	A mm	B mm	C mm	L mm
51407	16,81	561579	12	158	20	40	139

Incluye 5 cuchillas trapecio.



▶ HOJA PARA CUTTER METÁLICO 51407

REF.	€	8 41 4299	g	A mm	B mm	C mm	L mm
H51407	4,25	562538	10	10	0,5	19	60

Se presentan en blister 5 cuchillas.

## TIJERA CORTACHAPA

- Fabricadas en acero al Cromo Molibdeno de alta calidad, templado y revenido. Máxima duración.
- Cuchillas forjadas, de filos aserrados, con mecanismo multiplicador para reducir el esfuerzo de corte.
- Capacidad de corte de hasta 1,5 mm.
- Cumplen la normativa USA. ASMEB107.16.1998 y DIN 6438/11.71.

### Usos:

- Para corte de maestras, perfilera además de otros materiales de chapa galvanizada, aluminio o PVC.

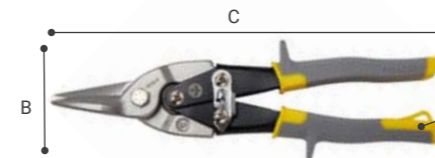

▶ TIJERA CORTE RECTO 6006-S

REF.	€	8 41 4299	g	A mm	B mm	C mm	L mm
6006-S	17,45	561388	6	390	25	74	250



▶ TIJERA CORTACHAPA CORTE DERECHA 6006R

REF.	€	8 41 4299	g	A mm	B mm	C mm	L mm
6006R	17,45	561401	6	390	25	74	250

NEW



▶ TIJERA CORTACHAPA CORTE IZQUIERDA 6006L

REF.	€	8 41 4299	g	A mm	B mm	C mm	L mm
6006L	17,45	561425	6	390	25	74	250

NEW

## PUNZONADORA

- Fabricada en materiales de alta calidad: máxima duración.
- Punzón de acero aleado y templado, alta calidad: alta capacidad de perforación.
- Excelente fijación, punzonado sólido y duradero.

### Usos:

- Para unir perfiles a la guía maestra.



▶ PUNZONADORA 6008

REF.	€	8 41 4299	g	A mm	B mm	C mm	L mm
6008	25,78	700916	1	860	25	75	310

## REMACHADORA



▶ REMACHADORA 6170

REF.	€	8 41 4299	g	A mm	B mm	C mm	L mm
6170	23,63	340778	6	538	25	80	260

# NIVELACIÓN Y MEDICIÓN LÁSER

1  
2  
3

## ▶ Autonivelante:

En superficies inclinadas de hasta 4° con alarma visual y/o auditiva de nivel y bloqueo de péndulo. Garantiza tu trabajo.

## ▶ Haz láser Clase II:

Con precisión de 0,3 mm/m y carcasas robusta con topes laterales anti impacto y protección IP54 a polvo y salpicaduras de agua desde todos los ángulos.

## ▶ Kits completos:

Incluyen rosca 1/4", soporte magnético y todo lo necesario para cada usuario.

### CARACTERÍSTICAS

- ▶ Proyecta su luz hasta 20 metros de distancia.
- ▶ Dispone de plano horizontal de nivel y plano vertical. Ambos con una amplitud de 120°.
- ▶ Dispone de imán, pilas y funda para su transporte.

### USOS

- ▶ Para sacar niveles y 1 escuadra. Para cualquier tipo de reformista o instalador.

### NIV20R NIV20V



### NIV30V



### NIV30360R NIV30360V NIV30360VT



### MED50R



- ▶ Proyecta su luz hasta 30 metros de distancia y dispone de 2 puntos de plomada verdes. Alcanza 50 metros con receptor.
- ▶ Dispone de plano horizontal de nivel con una amplitud de 120° y plano vertical con una amplitud 180°. 2 intensidades.
- ▶ Dispone de imán giratorio, pinza, placa reflectora, gafas, pilas y maletín resistente para su transporte.

- ▶ Para sacar niveles, 1 escuadra y obtener plomadas. Especialmente dirigido a albañiles y alicatadores y para cualquier tipo de reforma.

- ▶ Para sacar niveles y 2 escuadras.
- ▶ NIV30360R / NIV30360V: Especialmente dirigido a plaquistas y albañiles y para cualquier tipo de reforma.
- ▶ NIV30360VT: Especialmente dirigido a alicatadores para realizar la primera hilera.

- ▶ Dispone de imán giratorio, pinza, placa reflectora, batería cargada, cargador y maletín resistente para su transporte.
- ▶ Dispone de múltiples operaciones sumas, restas, área, volumen y Pitágoras y diferentes unidades de medida (mm, cm, Ft, inch...).
- ▶ Almacenamiento de memoria de 99 unidades. Incluye maleta, escuadra y rodillos de 6 y 10 mm.
- ▶ Dispone de funda textil, correa y pilas. Autonomía mínima de 8.000 pulsaciones.

- ▶ Para medir y calcular distancias, áreas y volúmenes y realizar presupuestos con facilidad.
- ▶ Para cualquier tipo de reformista.

# ¿QUÉ QUIERES HACER?



	NIV20R	NIV20V	NIV30V	NIV30360R	NIV30360V	NIV30360VT
Color						
Alcance	20	20	30 (hasta 50 m con receptor)	30 (hasta 50 m con receptor)	30 (hasta 50 m con receptor)	30 (hasta 50 m con receptor)
Batería / Pilas	Pilas	Pilas	Pilas	Batería	Batería	Batería
Apertura de haz	120x120	120x120	120x180 y 2 plomadas	360 x 3	360 x 3	360 x 3 (Plano bajo)



NIVEL DIGITAL

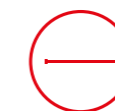

DISTANCIA



ÁREA



VOLUMEN

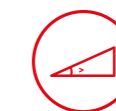

PITÁGORAS



OPERACIONES

# MEDICIÓN, MARCAJE Y NIVELACIÓN

## NIVELACIÓN LÁSER



► NIVEL LÁSER 20M

► NIVEL LÁSER VERDE CON PLOMADA NIV30V

REF.	€	8 41 4299	g	A mm	B mm	C mm	m	Color	
NIV20R	86,23	710731	1	210	75	64	73	20	●
NIV20V	106,53	710748	1	210	75	64	73	20	●

REF.	€	8 41 4299	g	A mm	B mm	C mm	m	Color	
NIV30V	202,95	710755	1	365	113	60	95	30	●



► NIVEL LÁSER 3X3600

► NIVEL LÁSER VERDE 3X3600 ESPECIAL ALICATADO NIV30360VT

NEW

REF.	€	8 41 4299	g	A mm	B mm	C mm	m	Color	
NIV30360V	405,95	713480	1	420	133	86	120	30	●
NIV30360R	304,45	710762	1	420	133	86	120	30	●

REF.	€	8 41 4299	g	A mm	B mm	C mm	m	Color	
NIV30360VT	405,95	039023	1	420	145	330	290	30	●



► BATERÍA NIVBAT

REF.	€	8 41 4299	g	A mm	B mm	C mm	
NIVBAT	30,40	710847	1	120	30	50	80



► SOPORTE MAGNÉTICO NIVIMAN

REF.	€	8 41 4299	g	A mm	B mm	C mm	
NIVIMAN	22,28	710823	1	270	100	60	130



► PINZA NIVPINZA

REF.	€	8 41 4299	g	A mm	B mm	C mm	
NIVPINZA	17,21	710854	1	300	70	90	190



NEW

► SOPORTE MAGNÉTICO NIVSOPM

REF.	€	8 41 4299	g	A mm	B mm	C mm	
NIVSOPM	44,95	042696	20	300	100	60	130



► TRÍPODE 1,5M NIVTRIPD15

REF.	€	8 41 4299	g	A mm	B mm	C mm	
NIVTRIPD15	37,51	710830	1	1.100	1.000	1.000	1.500

## MEDICIÓN LÁSER



► MEDIDOR LÁSER MED50R

REF.	€	8 41 4299	g	A mm	B mm	C mm	m	Color	
MED50R	71,00	710724	1	110	25	50	111	50	●

## CINTAS MÉTRICAS

- Máxima duración y resistencia.
- Carcasas compactas y ergonómicas, para mejor agarre y manejo muy fáciles de usar.
- Cinta con marcaje con graduación milimétrica.
  - 50021/50022: Cinta de fibra de vidrio muy resistente, flexible y lavable.
  - 50023: Cinta de acero al carbono con recubrimiento de nylon, máxima resistencia y mejor lectura de la cinta.
- Gancho de acero con forma abatible, fácil fijación en diferentes superficies.

### Usos:

- Para realizar trabajos de medición de larga distancia



► CINTA MÉTRICA 50021

REF.	€	8 41 4299	g	A mm	B mm	C mm	L mm
50021-10	12,94	447040	6	200	100	25	100
50021-20	16,85	618068	6	300	130	25	130
50021-30	21,85	618082	6	420	160	25	160
50021-50	28,38	618105	6	660	200	25	200

Cinta de fibra de vidrio de 24 hilos con marcaje por los dos lados. Carcasa de plástico. Con asa trasera en 30 y 50m. Sistema métrico, escalado milimétrico. Accionamiento rápido de palanca

\* 50021-10 HASTA FIN DE EXISTENCIAS



► CINTA MÉTRICA 50022

REF.	€	8 41 4299	g	A mm	B mm	C mm	L mm
50022-30	34,53	618129	2	940	220	40	300
50022-50	46,57	618143	2	1.250	350	40	270

Cinta de fibra de vidrio de 40 hilos ultra resistente con marcaje por los dos lados. Carcasa abierta ABS con zona de agarre ergonómica bimaterial. Sistema de rebobinado rápido x3. Sistema métrico, escalado milimétrico

\* 50022-30 HASTA FIN DE EXISTENCIAS



► CINTA MÉTRICA METÁLICA 50023

REF.	€	8 41 4299	g	A mm	B mm	C mm	L mm
50023-20	32,21	618167	6	400	125	30	125
50023-30	40,31	618181	6	480	125	30	125

Cinta de acero gama alta precisión. Clase II. Carcasa compacta de muy fácil manejo de acero anti-impactos recubierta de piel. Fleje metálico. Recubrimiento de Nylon. Carcasa metálica. Certificado Clase II

\* 50023-20 Y 50023-30 HASTA FIN DE EXISTENCIAS

## FLEXÓMETRO

- Cinta fabricada con acero especial, de gran duración y resistencia, sin torsión.
- Fleje de acero recubierto de barniz mate o de nylon, máxima resistencia y mejor lectura de la cinta.
- Carcasas compactas y ergonómicas, para mejor agarre y manejo: muy fáciles de usar.
- Gancho punta resistente con varios remaches, según producto.
- Amortiguador de retroceso de la hoja, evita roturas del gancho.
- Provistos de clip para sujeción en cinturón.
- Etiquetas con zona prevista para identificación y personalización.

### Usos:

- Para realizar trabajos de medición.



► FLEXÓMETRO BIMATERIAL INOXIDABLE 50014

REF.	€	8 41 4299	g	A mm	B mm	C mm	L mm
50014-3	4,59	706437	24	120	63	30	68
50014-5	6,13	706451	12	200	70	35	70
50014-8	10,25	706475	12	390	80	40	80
50014-5 IMP	7,16	706512	12	200	70	35	70 5m/16'
50014-8 IMP	10,25	706536	12	390	80	40	80 8m/26'

Gancho con 2 remaches. Carcasa de plástico y caucho muy resistente a los impactos. Antichoque. IMP: marcaje en mm y pulgadas

\* 500145IMP Y 500148IMP HASTA FIN DE EXISTENCIAS



► FLEXÓMETRO BIMATERIAL INOXIDABLE 50014M

REF.	€	8 41 4299	g	A mm	B mm	C mm	L mm
50014M-5	7,16	706499	12	200	75	35	70



► FLEXÓMETRO CROMADO 50012

REF.	€	8 41 4299	g	A mm	B mm	C mm	L mm
50012-5 BL	12,32	618280	6	230	70	40	70
50012-8 BL	18,45	618327	6	380	80	40	80

Ancho de cinta 25 mm. Marcaje por los dos lados. Gancho de 3 remaches extra-agarre. Botón inferior de bloqueo de la cinta. Recubrimiento de Nylon. Gancho de uso por los dos lados. Botón de bloqueo.



► FLEXÓMETRO CROMADO CON IMÁN 50012

REF.	€	8 41 4299	g	A mm	B mm	C mm	L mm
50012M-5 BL	14,14	618303	6	210	70	38	70

50012 con punta imantada con dos imanes de ferrita protegidos con un revestimiento antideslizante de caucho, máxima resistencia y evita su pérdida. Recubrimiento de Nylon. Punta imantada. Botón de bloqueo.



► FLEXÓMETRO BIMATERIAL INOXIDABLE 50013

REF.	€	8 41 4299	g	A mm	B mm	C mm	L mm
50013-5 BL	19,67	618341	6	370	70	50	70
50013-8 BL	23,04	618365	6	500	80	55	80

Ancho de cinta 33 mm, hasta 3 metros sin torsión. Gancho de 5 remaches extra-agarre. Carcasa bimaterial antideslizante de resistencia extrema ante impactos. Recubrimiento de Nylon. Fleje hasta 3 metros sin torsión.



► FLEXÓMETRO BIMATERIAL 50015

REF.	€	8 41 4299	g	A mm	B mm	C mm	L mm
500155	12,95	005776	12	290	70	45	70

NEW

## LÁPICES

- Lápices profesionales excelente marcaje y durabilidad.
- Minas de grafito alta calidad y gran grosor entre 4 mm y 7,5 mm.

### Usos:

- Para realizar trabajos de marcaje.

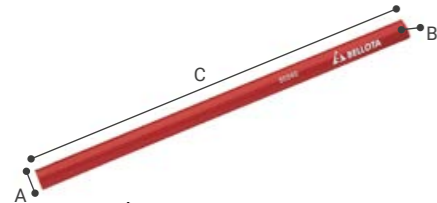

▶ LÁPIZ CARPINTERO 50240

REF.	€	8 41 4299	g	A mm	B mm	C mm
50240	2,41	044744	50	10	240	13 19



▶ LÁPIZ ESPECIAL PIEDRA 50241

REF.	€	8 41 4299	g	A mm	B mm	C mm
50241	2,57	044782	50	10	240	13 19



▶ LÁPIZ MULTIUSO 50243

REF.	€	8 41 4299	g	A mm	B mm	C mm
50243	6,49	044768	50	20	240	12 12



▶ LÁPIZ ESPECIAL SUPERFICIES HÚMEDAS 50244

REF.	€	8 41 4299	g	A mm	B mm	C mm
50244	2,23	044775	50	10	175	8 8



Marcaje resistente a la intemperie.



▶ KIT 3 LÁPICES DUO 50245

REF.	€	8 41 4299	g	A mm	B mm	C mm
50245-3	9,86	565652	20	40	175	10 10



MADERA SECA    MADERA HÚMEDA    PIEDRA/HORMIGÓN    METAL    CERÁMICA    PLÁSTICO    CRISTAL

50240	▲▲▲	▲	▲	▲		
50241	▲	▲	▲▲▲	▲		
50243	▲▲	▲▲	▲▲	▲▲	▲▲▲	▲
50244	▲▲▲	▲▲▲	▲▲	▲▲	▲	▲▲▲
50245	▲▲	▲▲	▲▲	▲	▲	▲▲▲

- ▲▲▲ Rendimiento óptimo
- ▲▲ Rendimiento excelente
- ▲ Rendimiento bueno

## NIVEL TUBULAR

- Alta precisión en la nivelación 0,5 mm/m. Fiolas resistentes al impacto y estables frente a los rayos ultravioletas. garantía de 15 años.
- Superficies de trabajo mecanizadas para mayor precisión y uso por ambos lados.
- Perfil tubular con doble nervadura para garantizar la máima resistencia.
- Topes antichoque monomateriales (50101) o bimateriales (50107)

### Usos:

- Para trabajos de nivelación



▶ NIVEL TABULAR 50101

REF.	€	8 41 4299	g	A mm	B mm	C mm
50101-30	17,88	600346	5	200	50	20 300
50101-40	19,61	600353	5	250	50	20 400
50101-50	20,86	600360	5	300	50	20 500
50101-60	22,63	600377	5	360	50	20 600
50101-80	25,43	600384	5	460	50	20 800
50101-100	28,99	600391	5	566	50	20 1.000
50101-120	35,56	611502	5	672	50	20 1.200
50101-150	42,30	611526	1	836	50	20 1.500
50101-180	50,32	611540	1	1.032	80	40 1.800
50101-200	57,11	611564	1	1.240	80	40 2.000

Con dos fiolas vertical y horizontal.



▶ NIVEL TABULAR MAGNÉTICO 50101

REF.	€	8 41 4299	g	A mm	B mm	C mm
50101M-40	24,52	611601	5	280	50	20 400
50101M-50	26,91	611625	5	340	50	25 500
50101M-60	29,15	611649	5	390	50	20 600
50101M-80	34,06	611663	5	480	50	20 800
50101M-100	38,84	611687	5	600	50	20 1.000
50101M-120	46,20	611700	5	780	50	20 1.200
50101M-30	22,34	611588	5	230	50	20 300

Nivel 50101 con imanes de ferrita de alta potencia. Hasta 4 imanes en longitudes superiores a 60 cm.



▶ NIVEL TUBULAR EXTRA 50107

REF.	€	8 41 4299	g	A mm	B mm	C mm
50107-40	31,24	611724	5	440	60	25 400
50107-60	40,78	503760	5	610	60	25 600
50107-80	44,31	503821	5	790	60	25 800
50107-100	49,94	611779	5	930	60	25 1.000
50107-120	52,63	611793	5	1.100	60	25 1.200

Perfil extra ancho con asas reforzadas de gran comodidad. Tres fiolas verticales y horizontales.



▶ NIVEL TUBULAR EXTRA MAGNÉTICO 50107

REF.	€	8 41 4299	g	A mm	B mm	C mm
50107M-40	42,25	611816	5	400	60	25 400
50107M-60	55,08	611830	5	660	60	25 600
50107M-80	59,85	611854	5	810	60	25 800
50107M-100	72,42	611878	5	960	60	25 1.000
50107M-120	76,32	611892	5	1.180	60	25 1.200

Nivel 50107 con imanes de neodimio ultra potentes, hasta 4 imanes en longitudes superiores a 80 cm.



▶ NIVEL TORPEDO MAGNÉTICO 50109

REF.	€	8 41 4299	g	A mm	B mm	C mm
50109-9	8,09	324594	10	90	38	20 230

Ranura en V para fácil lectura en tuberías y similares. Precisión 1 mm/m.

## NIVEL FUNDIDO

- Alta precisión en la nivelación 0,5 mm/m. Fiolas resistentes al impacto y estables frente a los rayos ultravioletas. Garantía de 15 años.
- Superficies de trabajo mecanizadas para mayor precisión.
- Perfil de aluminio fundido alta resistencia.

### Usos:

- Para trabajos de nivelación.



#### ► NIVEL FUNDIDO ALA DE AVIÓN 50102

REF.	€	8 41 4299	g	A mm	B mm	C mm	
50102-40	36,13	600407	5	380	42	21	400
50102-50	39,10	600414	5	540	42	21	500
50102-60	43,69	600421	5	490	42	21	600
50102-80	52,21	600438	5	780	42	21	800

Con dos fiolas vertical y horizontal.



#### ► NIVEL FUNDIDO ALA DE AVIÓN MAGNÉTICO 50106

REF.	€	8 41 4299	g	A mm	B mm	C mm	
50106-60	68,88	564976	5	510	45	20	600

Nivel 50102 con imanes de neodimio ultra potentes.



#### ► NIVEL FUNDIDO DOBLE T 50103

REF.	€	8 41 4299	g	A mm	B mm	C mm	
50103-60	53,48	942705	5	820	50	23	600
50103-80	64,09	942736	5	970	50	23	800

Con dos fiolas vertical y horizontal. Con asa para mayor comodidad.

## ESCUADRA

- Gran resistencia, duración y precisión.
- Escuadra de acero inoxidable, con talón de aluminio anodizado reforzado.

### Usos:

- Para realizar trabajos de medición y marcaje.

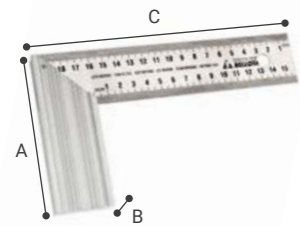

#### ► ESCUADRA INOXIDABLE 50215

REF.	€	8 41 4299	g	A mm	B mm	C mm	
50215-200	31,92	040142	6	150	115	15	200
50215-250	35,15	040173	6	190	140	15	253
50215-300	38,40	040203	6	230	165	15	300
50215-400	41,52	040234	6	260	165	15	400

## TIRALÍNEAS

- Carcasa de aluminio o polipropileno, compacta y muy resistente.
- Forma ergonómica para mejor agarre.
- Dispositivo de llenado fácil y rápido en el caso del tiralínea 50221, no requiere ni de apertura ni cierre.
- Cuerda de 30 m con alta retención de polvo trazador.
- Bloqueo de la cuerda al cerrar la manivela.
- Gancho de acero para facilitar la fijación en diferentes superficies.

### Usos:

Para realizar trabajos de marcaje.

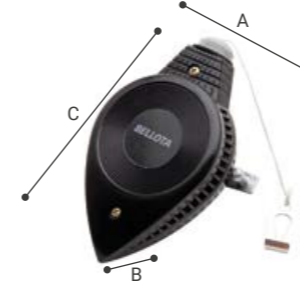

#### ► TIRALÍNEAS ALUMINIO 50220

REF.	€	8 41 4299	g	A mm	B mm	C mm	
50220	15,57	040104	6	230	75	30	125

Rellenado fácil.



#### ► TIRALÍNEAS BIMATERIAL 50221

REF.	€	8 41 4299	g	A mm	B mm	C mm	
50221	15,12	040128	6	160	80	40	135

Carcasa de plástico semitransparente con total visibilidad del polvo trazador facilitando así la detección de la necesidad de llenado- 50221-2. Doble carcasa. Rellenado fácil.



#### ► KIT TIRALÍNEAS BIMATERIAL 50222

REF.	€	8 41 4299	g	A mm	B mm	C mm	
50222	17,40	040081	6	370	190	55	250

50221 + Polvo trazador azul 113 grs. Rellenado fácil.



#### ► KIT TIRALÍNEAS METÁLICO 50223

REF.	€	8 41 4299	g	A mm	B mm	C mm	
50223	18,31	046106	6	440	140	50	160

50220 + Polvo trazador azul 113 grs. Rellenado fácil.



#### ► POLVO TRAZADOR 500 GRs. AZUL 50230

REF.	€	8 41 4299	g	A mm	B mm	C mm	
50230	8,66	040043	6	590	80	80	222



## PLOMADAS

- Plomada, tornillo y pletina de acero zincado para evitar corrosión.
- Cuerda de nylon muy resistente de 5 metros.

### Usos:

- Para verificar y alinear elementos verticales de obra, tales como paredes pilares, muros, etc.



► PLOMADA 50250

REF.	€	8 41 4299	g	A mm	B mm	C mm
50250-200	12,98	057683	4	300	180	45 200
50250-500	16,56	069532	4	780	180	45 200



► ESCUADRA MAGNÉTICA 50251

REF.	€	8 41 4299	g	A mm	B mm	C mm
50251	23,01	612851	4	275	90	43 140

## DISCOS DE DIAMANTE

### DISCOS DIAMANTE CORTE SECO

- Fabricados con diamantes de máxima calidad, gran tamaño y forma octogonal para conseguir el máximo rendimiento y vida útil del disco.
- Homogeneidad de los diamantes que asegura la calidad en el recorrido completo de la banda del disco.
- Perfecta unión entre el alma y el segmento que convierte las dos partes en un único elemento.
- Marcado láser que evita la pérdida de información, y la ralentización o posible embotamiento del disco.
- Diferentes tipos de segmentos: Los discos segmentados proporcionan una mayor velocidad de corte.
  - Los discos turbo proporcionan una mayor calidad de acabado y un corte más limpio que el segmentado.
  - Los discos de banda continua aseguran un corte fino y preciso.

### Usos:

- Para uso en máquinas portátiles con refrigeración por aire.
- General de obra: para corte de materiales que no tienen valores extremos ni en dureza ni abrasión: tejas, tejas de hormigón, ladrillos, terrazo, bloques de hormigón, baldosas...
- Materiales duros: para corte de materiales con valores extremos en dureza y medios en abrasión: granito, Klinker, cuarcita, pórfido, ladrillo refractario, hormigón curado, etc.
- Materiales abrasivos: para corte de materiales de baja dureza y alta capacidad abrasiva: hormigón fresco, bloques de hormigón aireado, hormigón viejo, terrazo silíceo, asfalto, ladrillo, arenisca, etc.
- Materiales cerámicos: para corte de cerámica y porcelánico.

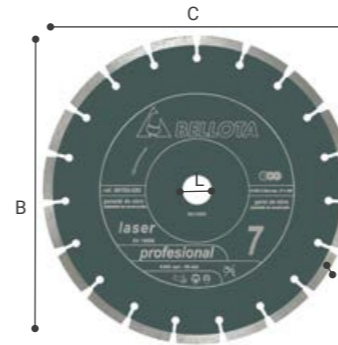

► DISCO GENERAL DE OBRA.SEGMENTADO. PROFESIONAL 50702

REF.	€	8 41 4299	g	A mm	B mm	C mm	L mm	Mbox	D mm	Nº	E mm
50702-115	29,98	051452	1	120	10	115	115	11	4	22,2	7 2,4
50702-125	32,65	051476	1	140	2	125	125	11	4	22,2	8 2,4
50702-230	61,01	051513	1	590	3	230	230	11	4	22,2	15 2,6



► DISCO GENERAL DE OBRA.TURBO. PROFESIONAL 50703

REF.	€	8 41 4299	g	A mm	B mm	C mm	L mm	Mbox	D mm	E mm
50703-115	18,19	051537	1	100	2	115	115	7	4	22,2 2
50703-125	20,24	051551	1	110	2	125	125	7	4	22,2 2,4
50703-230	46,03	051599	1	540	3	230	230	7	4	22,2 2,6



► DISCO GENERAL DE OBRA.SEGMENTADO. PRO 50701

REF.	€	8 41 4299	g	A mm	B mm	C mm	L mm	Mbox	D mm	Nº	E mm
50711-115	17,52	405453	1	100	2	115	115	7	4	22,2	9 1,8
50711-125	26,85	405484	1	120	2	125	125	7	4	22,2	10 1,8
50711-180	37,87	405514	1	310	3	180	180	7	4	22,2	14 2,2
50711-230	42,17	405545	1	520	3	230	230	7	4	22,2	16 2,4



► DISCO GENERAL DE OBRA.TURBO.PRO 50712

REF.	€	8 41 4299	g	A mm	B mm	C mm	L mm	Mbox	D mm	E mm
50712-115	17,15	405576	1	100	2	115	115	7	4	22,2 2
50712-125	19,99	405613	1	120	2	125	125	7	4	22,2 2,4
50712-180	32,98	405644	1	320	3	180	180	7	4	22,2 2,4
50712-230	44,75	405675	1	540	2,5	230	230	7	4	22,2 2,6



DISCO MATERIALES DUROS.SEGMENTADO.PROFESIONAL.50704

REF.	€	8 41 4299	g	A mm	B mm	C mm	L mm	Mbox	D mm	Nº	E mm
50704-115	29,15	051612	1	120	3	115	115	11	4	22,2	7 2,4
50704-125	33,35	051636	1	150	2	125	125	11	4	22,2	8 2,4
50704-230	59,97	051674	1	580	3	230	230	11	4	22,2	15 2,6



DISCO MATERIALES DUROS.TURBO.PROFESIONAL.50705

REF.	€	8 41 4299	g	A mm	B mm	C mm	L mm	Mbox	D mm	E mm
50705-115	20,26	051698	1	120	2	115	115	10	4	22,2 2,2
50705-125	25,18	051711	1	140	2	125	125	10	4	22,2 2
50705-230	49,99	051759	1	560	3	230	230	10	4	22,2 2,6



DISCO MATERIALES ABRASIVOS.SEGMENTADO.PROFESIONAL.50706

REF.	€	8 41 4299	g	A mm	B mm	C mm	L mm	Mbox	D mm	Nº	E mm
50706-230	85,44	051773	1	610	3	230	230	13	4	22,2	16 2,6
50706-350	181,79	051810	1	1.790	3	350	350	13	20	25,4	21 3,2



DISCO MATERIALES ABRASIVOS.TURBO.PROFESIONAL.50707

REF.	€	8 41 4299	g	A mm	B mm	C mm	L mm	Mbox	D mm	E mm
50707-230	50,14	051834	1	580	3	230	230	10	4	22,2 2,6



DISCO CERÁMICA. BANDA CONTINUA. PROFESIONAL 50722

REF.	€	8 41 4299	g	A mm	B mm	C mm	L mm	Mbox	D mm	E mm
50722-115	21,24	222838	1	100	1	115	115	7	4	22,2 1,5
50722-125	24,18	222890	1	120	2	125	125	7	4	22,2 1,5

Dentro de los materiales cerámicos encontramos el azulejo, el baldosin catalán, barro cocido... de uso en suelos y paredes tanto interiores como exteriores.



DISCO PORCELÁNICO. BANDA CONTINUA. PROFESIONAL 50734

REF.	€	8 41 4299	g	A mm	B mm	C mm	L mm	Mbox	D mm	E mm
50734-115	29,98	525670	1	100	2	115	115	7	4	22,2 1,6
50734-125	35,35	525700	1	120	2	125	125	7	4	22,2 1,6

El gres porcelánico es un material cerámico que, a diferencia del resto tiene muy baja absorción de agua lo que le confiere de un mayor nivel de dureza.



DISCO DIAMANTE FINO PARA CORTE PORCELÁNICO 50734-S

REF.	€	8 41 4299	g	A mm	B mm	C mm	L mm	Mbox	D mm	E mm
50734-S115	32,15	623192	1	100	2	115	115	10	4	22,2 1,2
50734-S125	37,78	641325	1	120	2	125	125	10	4	22,2 1,2



DISCO HORMIGÓN ARMADO.SEGMENTADO.PROFESIONAL 50735

REF.	€	8 41 4299	g	A mm	B mm	C mm	L mm	Mbox	D mm	E mm
50735-230	106,94	569308	1	590	3	230	230	13	4	22,2 2,6

Se trata de un material duro por efecto de la armadura, lo que condiciona la composición de los ligantes del disco.

## DISCOS DIAMANTE CORTE HÚMEDO

- Fabricados con diamantes de máxima calidad, gran tamaño y forma octogonal para conseguir el máximo rendimiento y vida útil del disco.
- Homogeneidad de los diamantes que asegura la calidad en el recorrido completo de la banda del disco.
- Perfecta unión entre el alma y el segmento que convierte las dos partes en un único elemento.
- Marcado láser que evita la pérdida de información, y la ralentización o posible embotamiento del disco.

### Usos:

- Para uso en máquinas estacionarias refrigeradas por agua tanto mesas de corte de diamante como cortadoras de cerámica.
- General de obra para corte de materiales que no tienen valores extremos ni en dureza ni abrasión tejas, tejas de hormigón, ladrillos, terrazo, bloques de hormigón, baldosas...
- Materiales duros para corte de materiales con valores extremos en dureza y medios en abrasión granito, Klinker, cuarcita, pórfido, ladrillo refractario, hormigón curado, etc.
- Materiales cerámicos para corte de cerámica y porcelánico



DISCO GENERAL DE OBRA.SEGMENTADO. PROFESIONAL 50708

REF.	€	8 41 4299	g	A mm	B mm	C mm	L mm	Mbox	D mm	Nº	E mm
50708-300	181,66	051896	1	1.020	3	300	300	11	1000	25,4	20 2,8
50708-350	235,73	051919	1	1.680	3	350	350	11	1000	25,4	24 3,2

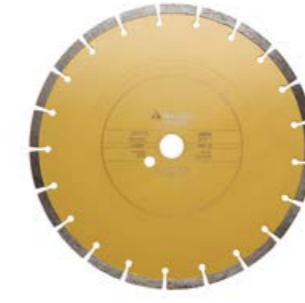

DISCO GENERAL DE OBRA.SEGMENTADO. PRO 50713

REF.	€	8 41 4299	g	A mm	B mm	C mm	L mm	Mbox	D mm	Nº	E mm
50713-300	109,07	405712	1	1.010	3	300	300	11	384	25,4	20 2,8
50713-350	133,79	314236	1	1.630	3	350	350	11	1000	25,4	21 3



DISCO MATERIALES DUROS.SEGMENTADO.PROFESIONAL.50724

REF.	€	8 41 4299	g	A mm	B mm	C mm	L mm	Mbox	D mm	Nº	E mm
50724-300	147,82	223491	1	1.300	2	300	300	13	1000	25,4	18 2,8
50724-350	205,68	223569	1	1.770	3	350	350	13	1	25,4	21 3

Entre estos materiales encontramos el granito, klinker, cuarcita, pórfido, hormigón curado...



DISCO PORCELÁNICO. BANDA CONTINUA. PROFESIONAL 50732

REF.	€	8 41 4299	g	A mm	B mm	C mm	L mm	Mbox	D mm	E mm
50732-180	41,23	373479	1	240	2	180	180	7	4	25,4 1,9
50732-230	70,64	373486	1	400	2	230	230	7	120	25,4 1,9
50732-300	97,94	373493	1	1.010	3	300	300	7	1000	25,4 2
50732-350	118,72	373516	1	1.500	3	350	350	7	16	25,4 2

El gres porcelánico es un material cerámico que, a diferencia del resto tiene muy baja absorción de agua lo que le confiere de un mayor nivel de dureza.

# CORONAS DE DIAMANTE



## CORONA DE DIAMANTE EN SECO M14 50750

REF.	€	8 41 4299	g	A mm	B mm	C mm	L mm	
507506	20,91	649963	10	130	35	35	120	35
507508	24,03	649987	1	140	35	35	120	35
5075010	25,97	650006	10	140	35	35	120	35
5075012	28,39	650020	1	140	35	35	120	35
5075014	31,05	650044	10	150	35	35	120	35
5075015	31,77	650068	10	150	35	35	120	35
5075018	39,02	650082	10	150	35	35	120	35
5075020	42,16	650105	1	160	35	35	120	50
5075022	45,80	650129	10	170	35	35	120	50
5075025	49,17	650143	1	180	35	35	120	50
5075035	61,96	650167	10	290	52	52	125	50
5075045	70,90	650181	10	340	52	52	125	50
5075050	81,52	650204	10	360	52	52	125	40
5075060	96,49	650228	1	520	73	73	125	40
5075065	102,28	650242	10	550	73	73	125	40
5075068	108,07	653670	10	570	73	73	125	40
5075028	52,89	065145	1	120	45	45	120	50
5075080	113,38	670455	1	570	73	73	125	40

## CORONA DE DIAMANTE EN SECO HEX6,5 50751

REF.	€	8 41 4299	g	A mm	B mm	C mm	L mm	
507516	21,40	650280	10	110	35	35	120	35
507518	23,57	650303	10	110	35	35	120	35
5075110	25,25	650327	10	110	35	35	120	35
5075112	27,44	650341	10	120	35	35	120	35
5075114	30,09	650365	10	120	35	35	120	35

## MINI KIT M14 50750 KIT

REF.	€	8 41 4299	g	A mm	B mm	C mm	L mm
50750KIT	101,32	650389	1	710	200	140	90

## MINI KIT HEX 6,5 50751 KIT

REF.	€	8 41 4299	g	A mm	B mm	C mm	L mm
50751KIT	98,91	650402	4	940	200	140	90



## MINI KIT M14 50750 KIT

REF.	€	8 41 4299	g	A mm	B mm	C mm	L mm
50750KIT1	197,48	656602	1	720	200	150	80



## ADAPTADOR DE M14 A HEX12 50750 M14

REF.	€	8 41 4299	g	A mm	B mm	C mm	L mm
50750M14	9,66	650266	1	150	52	52	125



## GUÍA PARA CORONAS CORTE SECO 50750 M14

REF.	€	8 41 4299	g	A mm	B mm	C mm	L mm
50750GUIDE	28,62	656640	1	180	70	70	125

## DISCOS FLEXIBLES DE DIAMANTE PARA PULIDO

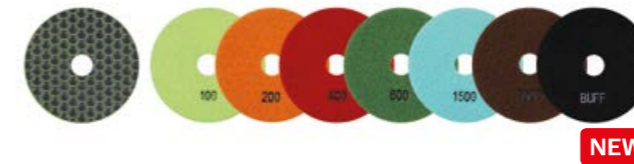

NEW



NEW

## DISCO FLEXIBLE DIAMANTADO DFDIAM

REF.	€	8 41 4299	g	A mm	B mm	C mm	
DFDIAM100	9,95	050639	6	25	100	100	3
DFDIAM200	9,95	050820	6	25	100	100	3
DFDIAM400	9,95	051117	6	25	100	100	3
DFDIAM800	9,95	051377	6	25	100	100	3
DFDIAM1500	9,95	050738	6	25	100	100	3
DFDIAM3000	9,95	051094	6	25	100	100	3
DFDIAMA	9,95	049664	6	25	100	100	3

## SOORTE PARA DISCOS FLEXIBLES DIAMANTADOS DFDIAMSM14

REF.	€	8 41 4299	g	A mm	B mm	C mm	
DFDIAMSM14	11,95	049695	6	151	93	93	30

## TACOS DE DIAMANTE PARA PULIDO



NEW

## TACO DIAMANTADO PARA DESBASTE Y PULIDO TDIAM

REF.	€	8 41 4299	g	A mm	B mm	C mm	
TDIAM60	19,95	045949	15	23	92	58	29,5
TDIAM120	19,95	046007	15	23	92	58	29,5
TDIAM200	19,95	046083	15	23	92	58	29,5
TDIAM400	19,95	046526	15	23	92	58	29,5

# LIMPIEZA

## HIDROLIMPIADORAS



**NEW**

HIDROLIMPIADORA DE 120 BAR HL1400E

REF.	€	8 41 4299	g	A mm	B mm	C mm	Kw	bar	l/h
HL1400E	110,60	032680	1	5.000	295	270	400	1,4	120 330



**NEW**

HIDROLIMPIADORA DE 140 BAR HL1700E

REF.	€	8 41 4299	g	A mm	B mm	C mm	Kw	bar	l/h
HL1700E	172,30	032819	1	9.000	307	307	651	1,7	140 380



**NEW**

HIDROLIMPIADORA DE 150 BAR HL2400PROE

REF.	€	8 41 4299	g	A mm	B mm	C mm	Kw	bar	l/h
HL2400PROE	312,30	032833	1	19.000	360	400	770	2,4	150 500



**NEW**

ASPIRADOR LÍQUIDOS Y SÓLIDOS SINCRONIZADO ASL2500SE

REF.	€	8 41 4299	g	A mm	B mm	C mm	Kw	L	kPa
ASL2500SE	88,06	032666	1	6.700	345	345	590	2	25 16

## ACCESORIOS PARA HIDROLIMPIADORAS



ACCESORIOS PARA HIDROLIMPIADORA HL1400E / HL1700E / HL2400PROE

REF.	€	8 41 4299	g	REF.	€	8 41 4299	g
AC59HL2400PRO	0,40	37968	1	HL2400PROE			
AC61HL1400	9,32	34639	1	HL1400E			
AC62HL1400	7,98	34738	1	HL1400E			
AC66HL1400	19,33	35292	1	HL1400E / HL2400PROE / HL2400PROE			
AC68HL1400	0,40	24807	1	HL1400E / HL1700E			
AC80HL	21,31	76608	1	HL1400E / HL1700E			
AC81HL	8,67	76646	1	HL1400E / HL1700E			
AC82HL	8,67	76660	1	HL1400E / HL1700E			
AC83HL	13,40	76707	1	HL1400E / HL1700E			
AC84HL	6,84	76738	1	HL1400E / HL1700E / HL2400PROE			
AC84HL1700	7,98	37111	1	HL1700E			
AC85HL	2,48	76752	1	HL1400E / HL1700E / HL2400PROE			
AC85HL1700	9,32	37135	1	HL1700E			
AC85HL2400PRO	26,26	38279	1	HL2400PROE			
AC86HL1700	25,74	37159	1	HL1700E			
AC86HL2400PRO	12,47	38309	1	HL2400PROE			
AC87HL2400PRO	10,96	38323	1	HL2400PROE			
AC89HL2400PRO	38,42	38361	1	HL2400PROE			
AC91HL2400PRO	8,24	38422	1	HL2400PROE			
MSF3HL	25,82	49091	1	HL1400E / HL1700E / HL2400PROE			

## ACCESORIOS PARA ASPIRADORAS



ACCESORIOS PARA ASPIRADORA ASL2500SE

REF.	€	8 41 4299	g	REF.	€	8 41 4299	g
AC16ASL2500S	6,14	38750	1	ASL2500SE			
AC20ASL2500S	7,68	38774	1	ASL2500SE			
AC27ASL2500S	14,29	38866	1	ASL2500SE			
AC38ASL2500S	16,82	38910	1	ASL2500SE			
AC43ASL2500S	21,02	38941	1	ASL2500SE			
AC44ASL2500S	10,23	38965	1	ASL2500SE			
AC45ASL2500S	2,52	38989	1	ASL2500SE			
AC46ASL2500S	2,52	39009	1	ASL2500SE			



Herramientas para  
dar vida a cualquier  
proyecto que quieras

# PARA EL TALLER

# DESTORNILLADORES

- Varilla Cromo-Molibdeno-Vanadio: máxima robustez y resistencia para soportar las tensiones de apriete.
- Tratamiento integral de temple y revenido en la varilla garantizando una dureza de 59Hrc.
- Mango con diseño trilobular: mayor transmisión de la fuerza de apriete, con geometría que se adapta perfectamente al movimiento natural de la mano, permitiendo hacer giros de 120 grados.
- Geometría de la espiga que garantiza un óptimo enmangado, evitando la rotación de la varilla en el mango.

## Usos:

- Ajuste perfecto entre la punta y el tornillo.

## BOCA VACIADA

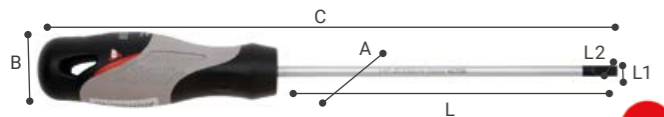

### ▶ DESTORNILLADOR BOCA VACIADA 66200

REF.	€	g	A mm	B mm	C mm	L mm	L1 mm	L2 mm
66200-3x75	3,67	148367	6	40	27	27	160	75
66200-3x100	3,80	148169	6	40	27	27	185	100
66200-3.5x100	4,09	148534	6	40	27	27	185	100
66200-4x100	4,71	148695	6	40	27	27	185	100
66200-4x125	4,56	148848	6	50	27	27	210	125
66200-5.5x125	5,86	148893	6	80	32	32	225	125
66200-5.5x150	6,65	148947	6	90	32	32	250	150
66200-6.5x150	7,90	148992	6	110	35	35	260	150

Para trabajos de apriete y para soltar tornillos.

## PHILIPS



### ▶ DESTORNILLADOR BOCA PHILLIPS 66220

REF.	€	g	A mm	B mm	C mm	L mm	L1 mm	L2 mm
66220-PH0	4,36	149814	6	40	27	27	160	75
66220-PH1	5,39	149869	6	70	31	31	200	100
66220-PH2	6,62	149920	6	100	34	34	235	125
66220-PH3	10,51	149982	6	170	38	38	270	150

Para trabajos de apriete y para soltar tornillos.

## JUEGO DESTORNILLADORES



### ▶ JUEGO DESTORNILLADORES MECÁNICO 66292

REF.	€	g	A mm	B mm	C mm
66292-MEC	35,22	153170	4	590	165
66200-3x100		66200-4x125		66210-5,5x125	
66210-6,5x150		66220-PH1		66220-PH2	

### ▶ JUEGO DESTORNILLADORES ELECTRICISTA 66291

REF.	€	g	A mm	B mm	C mm
66291-ELEC	31,38	333060	4	470	165
66200-3x100		66200-4x125		66200-5,5x125	
66220-PH0		66220-PH1		66220-PH2	

## BOCA PLANA



### ▶ DESTORNILLADOR BOCA ESTAMPADA 66210

REF.	€	g	A mm	B mm	C mm	L mm	L1 mm	L2 mm
66210-4x100	4,43	149319	6	40	27	27	185	100
66210-5.5x100	5,69	149364	6	80	32	32	200	100
66210-5.5x125	5,68	149425	6	80	32	32	225	125
66210-6.5x125	7,37	149470	6	100	35	35	235	125
66210-6.5x150	8,23	149531	6	110	34	35	260	150
66210-8x175	9,50	149647	6	150	36	38	300	175
66210-10x200	12,17	149692	6	180	38	38	320	200
66210-12x250	15,71	149753	6	230	35	38	370	250

Para trabajos de apriete y para soltar tornillos.

## POZIDRIV



### ▶ DESTORNILLADOR BOCA POZIDRIV 66230

REF.	€	g	A mm	B mm	C mm	L mm	L1 mm	L2 mm
66230-PZ0	5,32	150261	6	30	27	27	160	75
66230-PZ1	5,85	150315	6	70	32	32	200	100
66230-PZ2	7,13	150391	6	100	34	34	240	125
66230-PZ3	10,97	150452	6	170	38	38	270	150

Para trabajos de apriete y para soltar tornillos.

# LLAVES

- Fabricadas en Acero Cromo-Vanadio.
- Forjadas en una sola pieza, irrompibles.
- Tratamiento térmico 3+ para alargar la vida útil de la herramienta: no se rompe, no se deforma, no se desgasta.
- Alta precisión dimensional y ajuste de bocas.
- Pares de apriete 50% superior a la norma.
- Bocas largas, cuello ancho y mayor espesor de la cabeza para óptima sujeción de la cabeza del Tornillo.
- Cumplen exigencias de las normas DIN.

## Usos:

- Para trabajos de apriete y ajuste de todo tipo de tornillos.

## FIJA



### ▶ LLAVE FIJA 6400

REF.	€	g	A mm	B mm	C mm	L1 mm	L2 mm
6400-6x7	3,54	445558	6	20	4	15	120
6400-8x9	3,59	445619	6	30	4	21	130
6400-10x11	3,87	445671	6	60	5	26	150
6400-12x13	4,78	445749	6	70	5	30	168
6400-14x15	5,09	445800	6	140	5,5	20	145
6400-16x17	5,86	445862	6	130	6	37	200
6400-18x19	6,52	445930	6	180	7	40	216
6400-20x22	8,01	445992	6	210	7	45	235
6400-21x23	8,71	446081	6	260	8	50	240
6400-24x26	10,20	446173	6	350	8	55	260
6400-25x28	11,73	446210	6	400	9	60	267
6400-27x29	14,03	801231	6	440	9	60	267
6400-30x32	15,52	446296	6	510	10	65	296

Cumplen DIN 3110 y DIN 475.



### ▶ JUEGO LLAVES FIJAS 6490 CLIP

REF.	€	g	A mm	B mm	C mm	L1 mm	L2 mm
6490-8	45,22	781175	1	850	45	235	170
6400-6x7		6400-8x9		6400-10x11		6400-12x13	
6400-14x15		6400-16x17		6400-18x19		6400-20x22	
6490-10	67,34	781212	1	1.400	260	55	160
6400-6x7		6400-8x9		6400-10x11		6400-12x13	
6400-12x13		6400-14x15		6400-16x17		6400-18x19	
6400-18x19		6400-20x22		6400-21x23		6400-24x26	
6490-12	97,51	781250	1	2.440	290	67	185
6400-6x7		6400-8x9		6400-10x11		6400-12x13	
6400-12x13		6400-14x15		6400-16x17		6400-18x19	
6400-18x19		6400-20x22		6400-21x23		6400-24x26	
6400-24x26		6400-25x28		6400-30x32			



### ▶ JUEGO LLAVES FIJAS 6490 BOLSA

REF.	€	g	A mm	B mm	C mm	L1 mm	L2 mm
6490-8 BS	46,61	018400	1	830	60	60	290
6400-6x7		6400-8x9		6400-10x11		6400-12x13	
6400-14x15		6400-16x17		6400-18x19		6400-20x22	

## COMBINADA



▶ LLAVE COMBINADA 6410

REF.	€	g	A mm	B mm	C mm	L1 mm	L2 mm		
6410-6	4,79	446456	6	20	5	15	100	16	10,6
6410-7	4,79	446524	6	20	5	15	110	16,8	11,6
6410-8	4,92	446586	6	30	6	15	120	18,8	12,8
6410-9	5,91	446647	6	40	7	20	130	20,9	14,4
6410-10	5,98	446715	6	40	7	20	139	22,6	16
6410-11	6,52	446777	6	50	10	23	150	24	17,2
6410-12	6,88	446838	6	60	11	27	160	25,4	18,5
6410-13	7,09	446890	6	80	13	27	170	28,1	20,2
6410-14	7,43	446968	6	90	13	30	180	30,1	21,2
6410-15	7,63	447026	6	90	15	30	190	32,1	23
6410-16	8,21	447088	6	110	15	34	200	34,2	24,4
6410-17	8,76	447187	6	130	13	35	210	36	25
6410-18	9,23	447248	6	150	12	35	220	37,5	27,5
6410-19	10,40	447316	6	180	15	40	230	40,2	28,6
6410-20	10,65	447392	6	190	15	40	240	41,4	30,4
6410-21	12,05	447446	6	200	16	42	245	43,2	31,8
6410-22	12,46	447484	6	250	20	45	255	45,8	33

Cumplen DIN 3113 y DIN 475.



▶ JUEGO LLAVES COMBINADAS 6491 CLIP

REF.	€	g	A mm	B mm	C mm	L1 mm	L2 mm
6491-8	70,28	781298	1	800	260	36	130
6410-8		6410-10		6410-11			
6410-13		6410-14		6410-17			
6410-19		6410-22					
6491-12	98,76	781373	1	1.210	40	254	225
6410-8		6410-9		6410-10			
6410-11		6410-12		6410-13			
6410-14		6410-15		6410-16			
6410-17		6410-19		6410-22			

## ACODADA

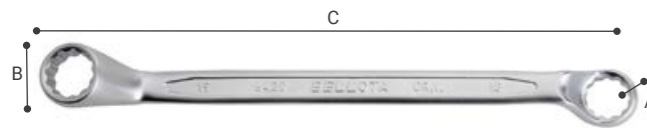

▶ LLAVE ESTRELLA ACORDADA 6420

REF.	€	g	A mm	B mm	C mm	L1 mm	L2 mm		
6420-6x7	7,77	447958	6	50	20	10	180	10,5	11,4
6420-8x9	8,50	447996	6	70	22	12	190	13,2	14,5
6420-10x11	9,09	448030	6	100	25	16	205	16,8	17,9
6420-12x13	9,67	448078	6	130	25	20	225	19,5	20,6
6420-14x15	10,40	448115	6	150	30	20	235	22,2	23
6420-16x17	12,54	448153	6	190	30	22	274	24,8	26
6420-18x19	14,39	448191	6	270	35	30	300	28,2	29,2
6420-20x22	16,55	448238	6	300	35	31	295	30,9	31,8
6420-21x23	18,65	448276	6	370	36	40	330	32	33,8
6420-24x26	23,06	448382	6	430	38	35	340	36,7	40,9

Cumplen DIN 837 y DIN 475.



▶ JUEGO LLAVES ESTRELLA ACORDADAS 6492 BOLSA

REF.	€	g	A mm	B mm	C mm	L1 mm	L2 mm
6492-8	88,44	781410	1	1.300	330	35	130
6420-6x7		6420-8x9		6420-10x11			
6420-12x13		6420-14x15		6420-16x17			
6420-18x19		6420-20x22					



▶ JUEGO LLAVES ESTRELLA ACORDADAS 6492 CLIP

REF.	€	g	A mm	B mm	C mm	L1 mm	L2 mm
6492-8 BS	88,44	018622	1	1.280	80	80	310
6420-6x7		6420-8x9		6420-10x11			
6420-12x13		6420-14x15		6420-16x17			
6420-18x19		6420-20x22					
6492-12 BS	189,19	018592	1	3.320	165,4	110,4	370
6420-6x7		6420-8x9		6420-10x11			
6420-12x13		6420-14x15		6420-16x17			
6420-18x19		6420-20x22		6420-21x23			
6420-24x26		6420-25x28		6420-30x32			

## TUBO

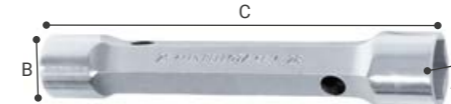

▶ LLAVE TUBO 6440

REF.	€	g	A mm	B mm	C mm	L1 mm	L2 mm		
6440-6x7	9,72	449266	6	40	10	10	105	10	11
6440-8x9	9,89	449310	6	60	13	13	110	13	14
6440-10x11	10,17	449358	6	90	15	15	120	15	16
6440-12x13	11,93	449396	6	140	18	18	140	18	19
6440-14x15	13,85	449433	6	100	20	22	185	20	22
6440-16x17	16,01	449471	6	190	23	24	155	23	24
6440-18x19	19,13	449518	6	240	25	26	165	25	26
6440-20x22	21,74	449556	6	300	28	30	170	28	30
6440-21x23	24,13	449594	6	340	30	31	185	29	31
6440-24x26	25,79	449693	6	410	33	35	185	33	35
6440-25x28	29,70	449730	6	480	34	37	205	34	37
6440-30x32	38,16	449815	6	640	40	42	210	40	42

Cumplen DIN 899. Posibilidad de utilizar con llave fija o ajustable. Agujero pasante desde la medida 10 x 11.



▶ JUEGO DE LLAVES 6495 BOLSA

REF.	€	g	A mm	B mm	C mm	L1 mm	L2 mm
6495-6 BS	57,66	618600	1	440	55	55	283
6441-6x7		6441-8x9		6441-10x11			
6441-12x13		6441-14x15		6441-16x17			



▶ LLAVE TUBO HUECA 6441

REF.	€	g	A mm	B mm	C mm	L1 mm	L2 mm		
6441-6x7	6,70	641905	6	30	10	11	110	10	11
6441-8x9	7,32	618587	6	40	10	10	120	12,5	13,5
6441-10x11	7,64	618617	6	50	12	12	125	14,5	16
6441-12x13	8,95	618648	6	70	15	15	136	17	18
6441-14x15	9,16	641936	6	70	18	18	137	19	20
6441-16x17	10,04	641967	6	120	21	21	146	22	23
6441-17x19	11,76	641998	6	140	25	25	165	23	28
6441-21x23	14,16	642025	6	190	27	27	167	28	30



▶ JUEGO LLAVES TUBO 6494 BOLSA

REF.	€	g	A mm	B mm	C mm	L1 mm	L2 mm
6494-6 BS	81,13	029741	1	850	180	26	170
6440-6x7		6440-8x9		6440-10x11			
6440-12x13		6440-14x15		6440-16x17			
6494-8 BS	112,47	029765	1	1.290	90	90	230
6440-6x7		6440-8x9		6440-10x11			
6440-12x13		6440-14x15		6440-16x17			
6440-18x19		6440-20x22					

## LLAVE STILSON

- Fabricadas en Acero Cromo-Vanadio.
- Cuerpo forjado en una sola pieza, irrompibles.
- Tratamiento térmico 3+ para alargar la vida útil de la herramienta: no se rompe, no se deforma, no se desgasta.
- Alta precisión dimensional y ajuste de bocas.
- Pares de apriete 30% superior a la norma.
- Bocas largas y delgadas para llegar a lugares difíciles y mejor sujeción de la tuerca.
- Perfecto rectificado, ajuste total suave y sin holguras.
- Sección del mango en doble T para mayor robustez, resistencia y ergonomía.
- Cumplen exigencias de las normas UNE 16-532.

Usos: Para trabajos de apriete y ajuste de todo tipo de tornillos.

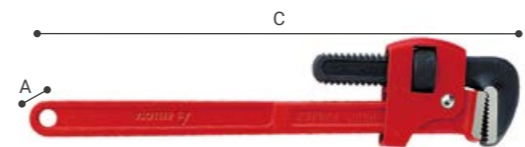

▶ LLAVE STILLSON 6800

REF.	€	g	A mm	B mm	C mm	L mm	L1 mm	L2 mm		
6600-8	21,14	967326	6	290	20	50	190	200	27	17
6600-10	24,86	967364	6	560	25	62	225	250	34	22
6600-12	27,52	967401	6	750	27	65	265	310	42	25
6600-14	34,28	967449	6	1.080	30	80	320	350	49	27
6600-18	42,15	967487	1	1.790	40	87	410	450	60	30
6600-24	69,61	967524	1	2.930	50	110	535	600	76	38
6600-36	129,15	967562	1	5.880	53	130	820	900	102	48

## LLAVE AJUSTABLE

- Fabricadas con Acero Especial Bellota.
- Cabeza con dientes de alta dureza, mínimo 55 HRC.
- Sección del mango en doble T para mayor robustez, resistencia y ergonomía.
- Acabado pavonado en zonas de uso y contacto para mayor durabilidad.
- Cumplen exigencias de las normas GGG-W-00651d (GSA-FSS) tipo 2 clase A.

### Usos:

- Para apretar, aflojar o ajustar piezas grandes.
- Para trabajos de fontanería.

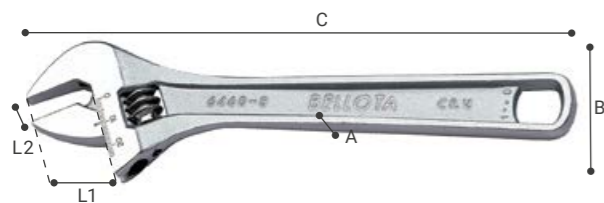

▶ LLAVE AJUSTABLE MOLETA CENTRAL 6460

REF.	€	8 41 4299	g	A mm	B mm	C mm	L1 mm	L2 mm
6460-6	20,31	451504	6	120	10	42	150	19,3
6460-8	23,37	451542	6	230	10	50	200	24
6460-10	28,29	451580	6	390	12	61	250	28,9
6460-12	37,37	451627	6	660	20	80	305	36
6460-15	54,43	451665	1	1.140	20	95	375	46



▶ LLAVE AJUSTABLE MOLETA LATERAL 6464

REF.	€	8 41 4299	g	A mm	B mm	C mm	L1 mm	L2 mm
6464-6	28,97	114430	6	150	12	52	152	18
6464-8	31,10	114133	6	270	12	65	205	26
6464-10	37,20	114317	6	500	15	80	260	32
6464-12	49,27	114379	6	820	20	93	307	36
6464-16	72,21	576245	1	1.510	25	117	405	48

PATENTADA UN 167063.



NEW

▶ LLAVE AJUSTABLE MOLETA CENTRAL BIMATERIAL 26461

REF.	€	8 41 4299	g	A mm	B mm	C mm	L1 mm	L2 mm
2646108	20,31	710045	6	300	15	80	260	73,3
2646110	23,37	710069	6	550	15	80	260	98

## LLAVE ALLEN

- Fabricadas en Acero Cromo-Vanadio.
- Dureza 50 HRC, para máxima resistencia.
- Chafán que facilita el embocado de la llave en el tornillo.
- Cumplen exigencias de las normas ISO 2936.

### Usos:

Para trabajos de apriete y ajuste de tornillos con cabeza Allen.

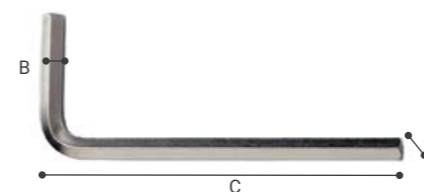

▶ LLAVE ALLEN NIQUELADA 6450

REF.	€	8 41 4299	g	A mm	B mm	C mm
6450-1.5 N	0,71	449853	12	5	1,5	15
6450-2 N	0,72	449914	12	8	2	18
6450-2.5 N	0,78	449952	12	10	2,5	19
6450-3 N	0,80	449990	12	10	3	21
6450-4 N	0,96	450033	12	10	5	27
6450-5 N	1,15	450071	12	20	5	34
6450-6 N	1,38	450118	12	30	7	37
6450-7 N	1,76	450156	12	40	6	40
6450-8 N	1,89	450194	12	60	8	45
6450-9 N	2,60	450231	12	70	9	45
6450-10 N	2,81	450279	12	100	11	45
6450-12 N	4,18	450446	1	170	12	55
6450-14 N	5,25	509120	1	270	15	70



▶ JUEGO NAVAJAS 8 LLAVES ALLEN 6455

REF.	€	8 41 4299	g	A mm	B mm	C mm
6455-8	16,75	618976	6	170	25	42
1,5		2				2,5
3		4				5
6		8				



▶ JUEGO 9 LLAVES ALLEN BOLA PAVONADAS 6457

REF.	€	8 41 4299	g	A mm	B mm	C mm
6457-9 P	22,01	507218	6	450	42	70
1,5		2				2,5
3		4				5
6		8				10



▶ JUEGO 9 LLAVES TORX INVOLABLES PAVONADAS 6459

REF.	€	8 41 4299	g	A mm	B mm	C mm
6459-9 TIP	23,98	610284	6	260	45	65
T9		T10				T15
T20		T25				T27
T30		T40				T50



▶ JUEGO 3 NAVAJAS 8 LLAVES ALLEN Y TORX

REF.	€	8 41 4299	g	A mm	B mm	C mm
6455-P3	43,00	618815	6	480	40	105
1,5		2				2,5
3		4				5
6		8				5/64'
3/32'		7/64'				1/8'
9/64'		5/32'				3/16'
7/32'		1/4'				T9
T10		T15				T20
T25		T27				T30
T40						



▶ JUEGO 9 LLAVES ALLEN NIQUELADAS 6458

REF.	€	8 41 4299	g	A mm	B mm	C mm
6458-9 N	18,84	507294	6	80	40	70
1,5		2				2,5
3		4				5
6		8				10



## LLAVE VASO

- Fabricadas en Acero Cromo-Vanadio.
- Forjadas en una sola pieza, irrompibles.
- Tratamiento térmico 3+ para alargar la vida útil de la herramienta: no se rompe, no se deforma, no se desgasta.
- Acabado niquelado y cromado mate.
- Cumplen exigencias de las normas DIN 3123 y 3124.

### Usos:

Para trabajos de apriete y ajuste de tornillos de cabeza hexagonal.

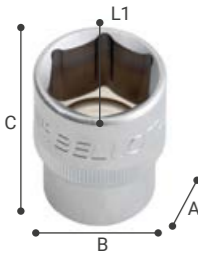

### ▶ LLAVE DE VASO 1/2" BOCA HEXAGONAL 6520

REF.	€	8 41 4299	g	A mm	B mm	C mm	L1 mm	L2 mm
6520-10	5,05	453010	6	60	20	38	15,5	22
6520-11	5,29	453058	30	60	20	38	16,7	22
6520-12	5,51	453096	30	60	20	38	18	22
6520-13	5,69	453133	30	30	20	38	19,2	22
6520-14	5,92	453171	30	60	20	38	20,5	22
6520-15	6,35	453218	30	60	22	38	22	21
6520-16	6,44	453256	30	60	21	38	22	21
6520-17	6,48	453294	30	70	23	38	24	22
6520-18	6,66	453331	30	80	24	38	25	23
6520-19	6,80	453379	30	80	25	38	26	24
6520-20	7,35	453416	50	90	28	38	28	26
6520-21	7,35	453454	6	80	28	38	28	26
6520-22	7,57	453492	50	100	30	38	30	26
6520-23	7,99	453539	50	120	30	38	32	28
6520-24	8,58	453591	6	120	30	38	32	28
6520-25	8,71	453638	6	140	33	42	34	30
6520-26	8,87	453676	30	170	36	42	36	36
6520-27	9,14	453713	6	160	36	42	36	36
6520-28	9,77	453775	30	200	36	42	38	38
6520-30	10,22	453867	20	210	40	44	40	40
6520-32	10,22	453911	20	230	42	44	42	42

### ▶ JUEGO 27 PIEZAS LLAVES DE VASO 1/2" 6592

REF.	€	8 41 4299	g	A mm	B mm	C mm	L1 mm	L2 mm
6592-1/2 H1	179,04	780611	1	5.230	80	380	305	

22 llaves de vaso, 2 alargaderas, 1 carraca, 1 mango corredizo y 1 articulación universal.



### ▶ ARTICULACIÓN UNIVERSAL 1/2" 6521

REF.	€	8 41 4299	g	A mm	B mm	C mm	L1 mm	L2 mm
6521	25,71	485110	1	166	25	25	135	



### ▶ MANGO CORREDIZO 1/2" 6524

REF.	€	8 41 4299	g	A mm	B mm	C mm	L1 mm	L2 mm
6524	18,16	485233	1	380	45	25	250	



### ▶ ALARGADERA 1/2" 6523

REF.	€	8 41 4299	g	A mm	B mm	C mm	L1 mm	L2 mm
6523-5	11,85	485158	10	230	22	22	185	
6523-10	14,93	485196	1	430	23	23	312	



### ▶ CARRACA PALAQUITA 1/2" 6528

REF.	€	8 41 4299	g	A mm	B mm	C mm	L1 mm	L2 mm
6528	50,57	485431	1	545	40	40	320	

## ALICATES

- Fabricadas con Acero Especial Bellota.
- Cabeza y cuerpo forjados: irrompibles.
- Tratamiento diferenciado en cabeza temple y revenido y filo temple por inducción para alargar la vida útil de la herramienta: no se rompe, no se deforma, no se desgasta.
- Mangos bimateriales ergonómicos con acabado SOFT TOUCH para mayor comodidad durante el trabajo.
- Cumplen exigencias de las normas DIN.

### Usos:

- Para trabajos de sujeción, amarre, corte o manipulación.
- Universales: Combinan sujeción, agarre y corte en una sola herramienta.
  - Sujeción: dentado liso y fino, sujeta sin marcar la superficie.
  - Amarre: dentado grueso para amarre redondos y tubos.
  - Corte: Materiales duros y semiduros hasta un diámetro de 2,5 mm.
- Cortante: Para corte de alambres.
- Manipulación y Multiapertura: para todo tipo de trabajos de sujeción.

## UNIVERSAL

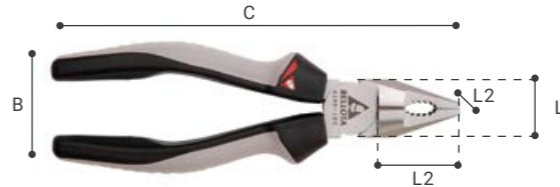

### ▶ ALICATE UNIVERSAL REFORZADO 6100

REF.	€	8 41 4299	g	A mm	B mm	C mm	L1 mm	L2 mm	Dmm	
6100-160 BIM	18,94	332797	6	210	35	54	165	25	9	35
6100-180 BIM	20,20	332926	6	270	38	54	185	25,8	9,6	38
6100-200 BIM	23,04	333022	6	300	40	57	210	28,5	9,8	40



### ▶ ALICATE UNIVERSAL 6102

REF.	€	8 41 4299	g	A mm	B mm	C mm	L1 mm	L2 mm	Dmm	
6102-160 BIM	19,22	333121	6	210	35	54	165	25	9,7	36
6102-180 BIM	21,28	333220	6	280	38	50	185	28	10	37
6102-200 BIM	23,88	333329	6	340	40	50	210	27,6	10,4	42

## CORTANTE



### ▶ ALICATE CORTANTE DIAGONAL 6110

REF.	€	8 41 4299	g	A mm	B mm	C mm	L1 mm	L2 mm	Dmm
6110-160 BIM	21,39	333527	6	240	23	53	165	21,8	20
6110-180 BIM	23,98	333626	6	290	23	56	185	23,4	20

Doble tratamiento en filos.



### ▶ ALICATE CORTANTE DIAGONAL REFORZADO 6112

REF.	€	8 41 4299	g	A mm	B mm	C mm	L1 mm	L2 mm	Dmm
6112-180 BIM	21,59	333725	6	250	23	53	190	26,8	21
6112-200 BIM	24,41	333909	6	290	23	55	200	26,9	21

Doble tratamiento en filos.



### ▶ ALICATE CORTANTE FRONTAL 6114

REF.	€	8 41 4299	g	A mm	B mm	C mm	L1 mm	L2 mm	Dmm
6114-160 BIM	24,31	333954	6	250	27	52	175	28,5	26

Doble tratamiento en filos.

## MANIPULACIÓN



▶ Alicate manipulación bocas semireondas rectas 6120

REF.	€	8 41 4299	g	A mm	B mm	C mm	L1 mm	L2 mm	D mm
6120-160 BIM	21,59	334050	6	110	18	53	164	16,7	2,5 52
6120-200 BIM	24,88	334159	6	190	20,5	53	203	17,5	1,7 76



▶ Alicate manipulación bocas semireondas curvas 6122

REF.	€	8 41 4299	g	A mm	B mm	C mm	L1 mm	L2 mm	D mm
6122-200 BIM	25,45	334258	6	190	22	52	200	17,5	2,5 71



▶ Alicate manipulación bocas planas 6130

REF.	€	8 41 4299	g	A mm	B mm	C mm	L1 mm	L2 mm	D mm
6130-160 BIM	22,90	334357	6	150	20	54	160	15,8	9,2 33



▶ Alicate pelacables 6150

REF.	€	8 41 4299	g	A mm	B mm	C mm	L1 mm	L2 mm	D mm
6150-160 BIM	26,21	334555	6	150	20	54	165	20	9

## MULTIAPERTURA

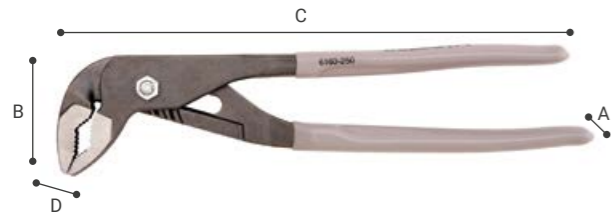

▶ Alicate multiapertura cremallera 6160

REF.	€	8 41 4299	g	A mm	B mm	C mm	L1 mm	L2 mm	D mm
6160-250 PVC	18,94	445367	6	250	12	55	250		34

\* HASTA FIN DE EXISTENCIAS



▶ Alicate multiapertura caja 6162

REF.	€	8 41 4299	g	A mm	B mm	C mm	L1 mm	L2 mm	D mm
6162-250 PVC	27,47	445442	6	310	13	50	245		34

## ALICATES AISLADOS

- Mangos aislados para trabajos eléctricos con tensión hasta 1.000V, con certificados VDE y acorde a normas DIN.
- Fabricadas con Acero Especial Bellota.
- Cabeza y cuerpo forjados en una sola pieza, irrompibles.
- Cabezas con tratamiento de temple y revenido diferenciado en cabeza y filo, para alargar la vida útil de la herramienta: no se rompe, no se deforma, no se desgasta.

### Usos:

- Para trabajos eléctricos de sujeción, amarre, corte o manipulación con tensión hasta 1.000V.



▶ Alicate universal aislado 26102

REF.	€	8 41 4299	g	A mm	B mm	C mm	L1 mm	L2 mm	D mm
26102160VDE	21,84	710083	12	210	32	58	170	25	10 35



▶ Alicate universal aislado 26110

REF.	€	8 41 4299	g	A mm	B mm	C mm	L1 mm	L2 mm	D mm
26110160VDE	22,86	710106	6	200	32	58	165	22	20



▶ Alicate manipulación bocas semireondas rectas aislado 26120

REF.	€	8 41 4299	g	A mm	B mm	C mm	L1 mm	L2 mm	D mm
26120160VDE	25,40	710144	6	150	28	55	170	17	2 72
26120200VDE	27,44	710168	12	200	30	55	210	18	3 100



▶ Alicate manipulación bocas semireondas curvas aislado 26122

REF.	€	8 41 4299	g	A mm	B mm	C mm	L1 mm	L2 mm	D mm
26122200VDE	27,44	710182	12	210	30	58	205	18	1,5 95



▶ Alicate pelacables aislado 26150

REF.	€	8 41 4299	g	A mm	B mm	C mm	L1 mm	L2 mm	D mm
26150160VDE	28,46	710120	12	200	30	60	170	20	8

## TIJERAS ELECTRICISTA

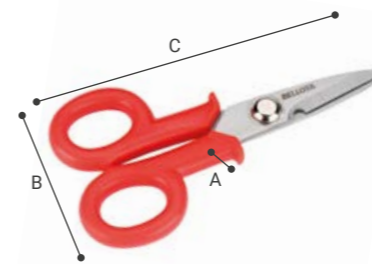

▶ Tijera electricista inoxidable 26010

REF.	€	8 41 4299	g	A mm	B mm	C mm	L1 mm	L2 mm	D mm
26010	8,10	714814	12	70	16	72	145		



▶ Tijera universal inoxidable 26011

REF.	€	8 41 4299	g	A mm	B mm	C mm	L1 mm	L2 mm	D mm
26011	10,13	714838	12	120	18	58	180		

# DISCOS ABRASIVOS

## DISCOS ABRASIVOS DE CORTE

- Cumplimiento de la normativa EN-12413.
- Fabricados con materias primas de la más alta calidad.
- Mezclas desarrolladas para conseguir una óptima relación entre rendimiento y sensación de corte.
- Homogeneidad de los discos, asegurando gran fiabilidad durante su vida útil.
- Excelente velocidad, sensación de corte y acabado.

### Usos:

- Para cortar, desbastar o sanear con máquina electroportátil o estacionaria.
- Discos Inoix-Metal: Modelos espesor 1-2 mm para trabajos en chapa fina y perfiles de hasta 33 mm y montajes con un acabado perfecto.
- Modelos 2-3 mm para trabajos exigentes de corte y trabajos en perfiles gruesos.
- Discos Piedra: Modelo 1 mm para trabajos en piedra, cerámica, perflería de cobre, aluminio, latón y plástico.
- Modelos 3 mm para trabajos exigentes en hormigón, ladrillo, piedra y cerámica.
- Tres tipos de grano:
  - A- Corindón: grano de elevada tenacidad adecuada para corte y desbaste profesional. Especialmente recomendado para trabajos en metal.
  - AS- Corindón Semifriable: grano de elevada friabilidad y buena tenacidad. Ideal para corte de acero inoxidable.
  - C- Carburo de silíceo: para materiales frágiles (piedra, marmol y granito) y materiales blandos (aluminio, cobre).



DISCO CORTE INOIX-METAL EXTRAFINO 50300-50310-50320

REF.	€	8 41 4299	g	A mm	B mm	C mm	mm/inch	E mm
50300-115	1,69	014785	25	30	1	115	115	22,23
50300-125	1,83	014808	25	30	1	125	125	22,23

Disco plano. Disco centro en depresión.



DISCO CORTE INOIX-METAL EXTRAFINO 50300-50310-50320

REF.	€	8 41 4299	g	A mm	B mm	C mm	mm/inch	E mm
50310-115	1,83	014822	25	40	2	115	115	22,23
50310-125	2,09	014839	25	40	1	125	125	22,23

Disco plano. Disco centro en depresión.



DISCO CORTE INOIX-METAL EXTRAFINO 50300-50310-50320

REF.	€	8 41 4299	g	A mm	B mm	C mm	mm/inch	E mm
50320-180	3,29	139617	25	80	3	180	180	22,23
50320-230	3,40	139679	25	180	4	230	230	22,23

Disco plano. Disco centro en depresión.



DISCO CORTE INOIX-METAL FINO 50330

REF.	€	8 41 4299	g	A mm	B mm	C mm	mm/inch	E mm
50330-115	1,88	373806	25	60	7	115	115	22,23
50330-125	2,06	374001	25	70	6	125	125	22,23
50330-180	2,60	374179	25	160	10	180	180	22,23
50330-230	3,80	374292	25	220	5	230	230	22,23

Disco centro en depresión.



DISCO CORTE INOIX-METAL 50301

REF.	€	8 41 4299	g	A mm	B mm	C mm	mm/inch	E mm
50301-115	1,88	600711	25	70	7	115	115	22,23
50301-125	2,06	600728	25	90	6	125	125	22,23
50301-180	2,60	600735	25	180	6	180	180	22,23
50301-230	3,70	600742	25	270	7	230	230	22,23

Disco centro en depresión.



DISCO CORTE METAL MAQUINA ESTACIONARIA 50431-50442-50321

REF.	€	8 41 4299	g	A mm	B mm	C mm	mm/inch	E mm
50441-300	10,05	941005	25	550	4	300	300	25,4

Disco plano.



DISCO CORTE PIEDRA EXTRAFINO 50322

REF.	€	8 41 4299	g	A mm	B mm	C mm	mm/inch	E mm
50322-115	2,10	606768	25	20	1	115	115	22,23

Disco plano.



DISCO CORTE INOIX-METAL FINO 50420

REF.	€	8 41 4299	g	A mm	B mm	C mm	mm/inch	E mm
50420-115	2,53	388923	25	50	7	115	115	22,23
50420-230	5,06	389265	25	220	5	230	230	22,23

Disco centro en depresión.



DISCO CORTE METAL MAQUINA ESTACIONARIA 50431-50442-50321

REF.	€	8 41 4299	g	A mm	B mm	C mm	mm/inch	E mm
50431-300	10,05	940961	25	560	4	300	300	22,23

Disco plano.



DISCO CORTE METAL MAQUINA ESTACIONARIA 50431-50442-50321

REF.	€	8 41 4299	g	A mm	B mm	C mm	mm/inch	E mm
50321-350	16,07	600926	25	770	4	350	350	25,4

Disco plano.



DISCO CORTE PIEDRA 50302

REF.	€	8 41 4299	g	A mm	B mm	C mm	mm/inch	E mm
50302-115	2,09	600759	25	60	9	115	115	22,23
50302-125	2,21	600766	25	70	8	125	125	22,23
50302-230	4,25	600780	25	230	5	230	230	22,23

Disco centro en depresión.



DISCO CORTE INOIX-METAL 50421

REF.	€	8 41 4299	g	A mm	B mm	C mm	mm/inch	E mm
50421-115	2,53	924596	25	70	10	115	115	22,23
50421-125	2,68	924633	25	80	10	125	125	22,23
50421-180	3,49	924671	25	180	7	180	180	22,23
50421-230	5,06	924718	25	290	5	230	230	22,23

Disco centro en depresión.



DISCO CORTE INOX-METAL EXTRAFINO 50400

REF.	€	g	A mm	B mm	C mm	mm/inch	E mm
50400-115	1,09	556506	25	20	2	115/115	22,23 1 AS 60 INOX - BF
50400-125	1,25	586848	25	30	2	125/125	22,23 1 AS 60 INOX - BF

Disco plano.



DISCO CORTE INOX-METAL 50480

REF.	€	g	A mm	B mm	C mm	mm/inch	E mm
50480-115	1,02	446999	25	70	6	115/115	22,23 3 A 24 R - BF
50480-125	1,12	512656	25	80	7	125/125	22,23 3 A 24 R - BF
50480-230	2,35	447057	25	280	7	230/230	22,23 3 A 24 R - BF

Disco centro en depresión.



DISCO CORTE PIEDRA 50482

REF.	€	g	A mm	B mm	C mm	mm/inch	E mm
50482-115	1,17	447118	25	60	6	115/115	22,23 3 C 24 R - BF
50482-230	2,37	447163	25	230	6	230/230	22,23 3 C 24 R - BF

Disco centro en depresión.

## DISCOS ABRASIVOS DE DESBASTE



DISCO DESBASTE INOX-METAL/DURO 50351

REF.	€	g	A mm	B mm	C mm	mm/inch	E mm
50351-115	2,70	124422	10	160	10	115/115	22,23 7 A 30 T - BF
50351-125	3,07	124552	10	190	15	125/125	22,23 7 A 30 T - BF
50351-180	5,22	124828	10	410	10	180/180	22,23 7 A 30 T - BF
50351-230	7,00	124958	10	620	9	230/230	22,23 7 A 30 T - BF

Disco centro en depresión.



DISCO DESBASTE INOX-METAL/BLANDO 50361

REF.	€	g	A mm	B mm	C mm	mm/inch	E mm
50361-115	2,70	125221	10	160	10	115/115	22,23 7 AS 30 Q - BF
50361-125	3,07	125337	10	200	12	125/125	22,23 7 AS 30 Q - BF
50361-180	5,22	125429	10	410	10	180/180	22,23 7 AS 30 Q - BF
50361-230	7,00	125535	10	650	10	230/230	22,23 7 AS 30 Q - BF

Disco centro en depresión.



DISCO DESBASTE PIEDRA 50352

REF.	€	g	A mm	B mm	C mm	mm/inch	E mm
50352-115	3,01	124576	10	140	12	115/115	22,23 7 C 30 S - BF

Disco centro en depresión.

# DISCOS DE LÁMINAS

## BASE DE POLIAMIDA

- Base plana para trabajos en superficies planas.
- No ensucia ni raya la superficie trabajada.
- Mayor aprovechamiento del disco ya que la base se desgasta junto con el abrasivo durante el uso.
- Telas con soporte de algodón que proporcionan muy buena sensación de repasado y evitan marcas de quemado en el material. Ideal para trabajos en acero inoxidable.
- Vida útil 15% superior a discos con base fibra de vidrio

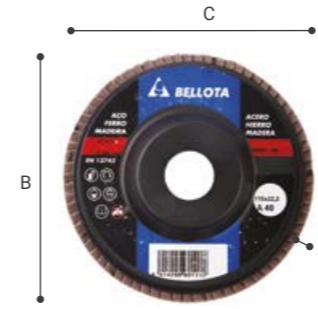

DISCO DESBASTE METAL. GRANO 50501

REF.	€	g	A mm	B mm	C mm	mm/inch
50501-40	8,17	601152	10	100	20	108/108 22,2 A 40
50501-60	8,17	601169	10	90	19	108/108 22,2 A 60
50501-80	8,17	601176	10	90	18	108/108 22,2 A 80
50501-120	8,17	601220	10	90	17	108/108 22,2 A 120

Disco centro en depresión.



DISCO DESBASTE INOX-METAL. GRANO AZ 50502

REF.	€	g	A mm	B mm	C mm	mm/inch
50502-40	9,13	601190	10	100	20	108/108 22,2 AZ 40
50502-60	9,13	601206	10	100	19	108/108 22,2 AZ 60
50502-80	9,13	601213	10	90	18	108/108 22,2 AZ 80
50502-120	9,13	601237	10	80	17	108/108 22,2 AZ 120

Disco centro en depresión.



DISCO DESBASTE PIEDRA. GRANO SIC 50503

REF.	€	g	A mm	B mm	C mm	mm/inch
50503-40	8,82	601244	10	90	20	108/108 22,2 SIC 40
50503-60	8,82	601251	10	90	19	108/108 22,2 SIC 60
50503-80	8,82	601268	10	80	18	108/108 22,2 SIC 80
50503-120	8,82	601275	10	80	17	108/108 22,2 SIC 120

Disco centro en depresión.

## BASE DE FIBRA DE VIDRIO

- Base inclinada para trabajos de repasado sobre canto.
- No ensucia, ni raya la superficie trabajada.
- Telas con soporte de poliéster que aportan gran rendimiento.



► DISCO DESBASTE METAL. GRANO A 50511-50551-50611

REF.	€	8 41 4299	g	A mm	B mm	C mm	Ø mm/inch
50511-40	5,72	941302	10	80	10	108	22,2 A 40
50511-60	5,72	941333	10	70	10	108	22,2 A 60
50511-80	5,72	941364	10	70	10	108	22,2 A 80
50511-120	5,72	941395	10	70	11	108	22,2 A 120

Disco centro en depresión.



► DISCO DESBASTE METAL. GRANO A 50511-50551-50611

REF.	€	8 41 4299	g	A mm	B mm	C mm	Ø mm/inch
50551-60	6,47	300314	10	100	12	116	22,2 A 60

Disco centro en depresión

\* 50551-60 HASTA FIN DE EXISTENCIAS



► DISCO DESBASTE METAL. GRANO A 50511-50551-50611

REF.	€	8 41 4299	g	A mm	B mm	C mm	Ø mm/inch
50611-40	11,22	941661	10	200	11	170	22,2 A 40
50611-60	11,22	941692	10	210	10	170	22,2 A 60
50611-80	11,22	941722	10	210	10	170	22,2 A 80

Disco centro en depresión.

\* 50611-60 Y 50611-80 HASTA FIN DE EXISTENCIAS.



► DISCO DESBASTE PIEDRA. GRANO SIC 50513

REF.	€	8 41 4299	g	A mm	B mm	C mm	Ø mm/inch
50513-40	6,25	941548	10	70	14	108	22,2 SIC 40
50513-60	6,25	941579	10	70	13	108	22,2 SIC 60
50513-80	6,25	941609	10	70	12	108	22,2 SIC 80
50513-120	6,25	941630	10	70	10	108	22,2 SIC 120

Disco centro en depresión.

## CEPILLOS

- Fabricados con materiales de alta calidad para garantizar un excelente rendimiento.
- Alta resistencia al desgaste del alambre.
- Óptima combinación de materiales y tipos de alambre para garantizar la precisión de acabado requerida.

### Usos:

- Para trabajos de cepillado, limpieza y eliminación de pinturas, barnices, cascarilla, óxidos y pequeñas rebabas.
- Cuatro materiales de alambre:
  - Acero Inoxidable: ideal para limpiar sin contaminar, manchas de oxidación y hollín en acero inoxidable, aluminio o aleaciones especiales.
  - Acero Latonado: ideal para trabajar cobre, plástico, plomo, aluminio, vidrio y acero.
  - Latón: ideal para metales no férricos y trabajos antichispa.
  - Nylon: ideal para zonas de difícil acceso. Grano grueso (Rojo) acabado basto. Grano Fino (Azul) acabado fino.
- Tres materiales de alambre:
  - Alambre trenzado: ideal para obtener un máximo rendimiento en trabajos pesados y trabajos que requiere rapidez y firmeza.
  - Alambre ondulado: ideal para labores de cepillado continuo y remover rebabas ligeras. Acabados finos.
  - Alambre recto: Ideal para todo tipo de cepillado. Acabado Medio.

## CEPILLOS MANUALES

- Para trabajos ligeros de cepillado. Uso general.



► CEPILLO ACERO LATONADO ALAMBRE RECTO 50801

REF.	€	8 41 4299	g	A mm	B mm	C mm	H
50801-3	1,52	372380	24	100	45	27	292 3
50801-4	1,75	372427	24	130	47	33	295 4
50801-5	2,34	372465	24	130	46	38	295 5

Acero latonado. Alambre recto Ø 0,3.



► CEPILLO ACERO INOXIDABLE ALAMBRE RECTO 50802

REF.	€	8 41 4299	g	A mm	B mm	C mm	H
50802-3	5,57	372502	24	100	45	28	295 3
50802-4	6,72	372540	24	100	45	32	290 4
50802-5	8,02	372588	24	120	35	40	300 5

Acero latonado. Alambre recto Ø 0,3.



► CEPILLO LATÓN ALAMBRE ONDULADO 50803

REF.	€	8 41 4299	g	A mm	B mm	C mm	H
50803-3	3,30	372625	24	80	45	27	295 3
50803-4	4,40	372663	24	110	45	30	295 4
50803-5	5,88	372700	24	140	45	36	291 5

Latón. Alambre ondulado Ø 0,3.



► CEPILLO ACERO LATONADO ALAMBRE RECTO 50804

REF.	€	8 41 4299	g	A mm	B mm	C mm	H
50804-5	2,66	372748	24	130	47	36	290 5

Sin mango para trabajos fuertes.



► CEPILLO ACERO LATONADO ALAMBRE RECTO 50806-A

REF.	€	8 41 4299	g	A mm	B mm	C mm	H
50806-A	2,08	372823	24	110	20	65	260

Muy estrechos para lugares de difícil acceso.



► CEPILLO LATÓN ALAMBRE ONDULADO 50806-L

REF.	€	8 41 4299	g	A mm	B mm	C mm	H
50806-l	6,41	372861	24	110	20	65	255

Muy estrechos para lugares de difícil acceso.



▶ CEPILLO ACERO INOXIDABLE ALAMBRE ONDULADO 50806-I

REF.	€	8 41 4299	g	A mm	B mm	C mm	H
50806-L	6,10	372908	24	110	20	65	250

Muy estrechos para lugares de difícil acceso.



▶ LIMPIABUJÍAS 50805L

REF.	€	8 41 4299	g	A mm	B mm	C mm	H
50805-L	4,03	633832	24	40	20	72	172

Latón alambre ondulado 0,15 mm diámetro.

## CEPILLOS BRICOLAJE

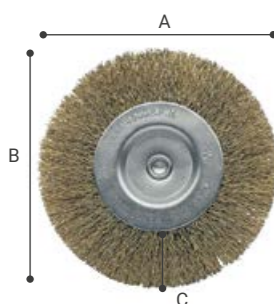

▶ CEPILLOS CIRCULARES ACERO LATONADO ALAMBRE ONDULADO 50807

REF.	€	8 41 4299	g	A mm	B mm	C mm	L1 mm	L2 mm	RPM max
50807-50	1,86	373066	24	40	50	50	35	10	8 4500
50807-60	1,86	373103	24	50	60	60	37	14	8 4500
50807-75	2,29	373141	24	70	75	75	40	16	10 4500
50807-100	3,51	373189	12	110	100	100	40	23	10 4500

Alambre ondulado 0,30 mm diámetro. Perno de 6 mm.



▶ CEPILLO BRICOLAJE CIRCULAR ACERO INOXIDABLE ALAMBRE ONDULADO 50807-I

REF.	€	8 41 4299	g	A mm	B mm	C mm	L1 mm	L2 mm	RPM max
50807-50 I	4,51	686784	24	40	50	50	35	10	8 4500
50807-75 I	5,94	686869	24	70	75	75	40	16	10 4500



▶ CEPILLOS TAZA ACERO LATONADO ALAMBRE ONDULADO 50808

REF.	€	8 41 4299	g	A mm	B mm	C mm	L1 mm	L2 mm	RPM max
50808-50	2,39	373226	24	70	55	55	64	18	50 4500
50808-75	3,46	373264	24	120	70	70	25	75	4500
50808-80	4,26	936193	12	200	75	80	25	75	4500

Alambre ondulado 0,30 mm diámetro. Perno de 6 mm.



▶ CEPILLOS TAZA ACERO INOXIDABLE ALAMBRE ONDULADO 50808-I

REF.	€	8 41 4299	g	A mm	B mm	C mm	L1 mm	L2 mm	RPM max
50808-50 I	8,43	633733	24	70	55	55	64	18	50 4500

Alambre ondulado 0,30 mm diámetro. Perno de 6 mm.



▶ CEPILLOS BROCHA ACERO LATONADO ALAMBRE ONDULADO 50809

REF.	€	8 41 4299	g	A mm	B mm	C mm	L1 mm	L2 mm	RPM max
50809-25	3,26	373301	24	60	30	30	75	31	25 4500

Alambre ondulado 0,30 mm diámetro. Perno de 6 mm.



▶ EXPOSITOR CEPILLOS BRICOLAJE 50850

REF.	€	8 41 4299	g	A mm	B mm	C mm	L1 mm	L2 mm	RPM max
50850	100,16	904031	1	3.093	358	220	122		4500

## CEPILLOS INDUSTRIALES CIRCULARES

• Para trabajar en esmeriladoras de banco fijo.



▶ CEPILLOS CIRCULARES ACERO LATONADO ALAMBRE ONDULADO 50810

REF.	€	8 41 4299	g	A mm	B mm	C mm	L1 mm	L2 mm	RPM max
50810-10016	11,87	373387	6	300	100	100	20	22	16 8000
50810-10020	16,66	373424	6	250	100	100	25	22	20 8000
50810-12518	12,80	373462	6	300	125	125	20	30	18 8000
50810-15018	16,02	373547	6	560	150	150	30	27,5	18 6000
50810-20020	21,27	373707	6	850	200	200	30	42,5	20 4500
50810-20025	29,99	373745	6	740	200	200	30	42,5	25 4500

Alambre ondulado 0,30 mm diámetro.



▶ CEPILLOS CIRCULARES ACERO TEMPLADO ALAMBRE TRENZADO 50811

REF.	€	8 41 4299	g	A mm	B mm	C mm	L1 mm	L2 mm	RPM max
50811-100	20,80	373783	6	180	100	100	15	20,5	12 12500
50811-115	21,27	373936	6	220	115	115	20	22	12 12500
50811-150	25,77	374124	6	480	150	150	20	36,5	13 9000
50811-175	29,12	374162	6	660	175	175	20	42,5	13 9000

## CEPILLOS INDUSTRIALES TAZA

• Para trabajar grandes superficies metálicas en amoladoras angulares y en miniamoladoras para zonas de difícil acceso.



▶ CEPILLOS TAZA ACERO LATONADO ALAMBRE ONDULADO 50812

REF.	€	8 41 4299	g	A mm	B mm	C mm	L1 mm	L2 mm	RPM max
50812-80	16,43	374209	6	240	85	85	60	28	80 8500
50812-100	20,12	374247	6	460	105	105	70	30	100 8500
50812-125	29,52	374285	6	490	120	120	80	35	125 8500

Alambre ondulado 0,30 mm diámetro.



▶ CEPILLOS TAZA ACERO INOXIDABLE ALAMBRE ONDULADO 50812-I

REF.	€	8 41 4299	g	A mm	B mm	C mm	L1 mm	L2 mm	RPM max
50812-80 I	32,17	633771	12	230	85	85	60	28	80 8500

Alambre ondulado 0,30 mm diámetro.



▶ CEPILLOS TAZA ACERO TEMPLADO ALAMBRE TRENZADO 50813

REF.	€	8 41 4299	g	A mm	B mm	C mm	L1 mm	L2 mm	RPM max
50813-80	23,41	374322	6	670	85	85	75	28	85 8500
50813-100	24,88	374360	6	1.000	105	105	80	21	100 8500
50813-120	31,39	374407	6	1.180	120	120	78	23	120 8500



▶ CEPILLOS TAZA ACERO LATONADO ALAMBRE ONDULADO 50814

REF.	€	8 41 4299	g	A mm	B mm	C mm	L1 mm	L2 mm	RPM max
50814-75	15,48	374445	12	220	75	75	58	28	75 12500

Para uso en miniamoladoras. Alambre ondulado 0,30 mm diámetro.



▶ CEPILLOS TAZA ACERO TEMPLADO ALAMBRE TRENZADO 50814

REF.	€	8 41 4299	g	A mm	B mm	C mm	L1 mm	L2 mm	RPM max
50814-65	14,91	374483	12	280	73	73	50	21,5	12500

Para uso en miniamoladoras. Alambre ondulado 0,30 mm diámetro.

## CEPILLOS INDUSTRIALES CÓNICOS

• Para uso en mini-amoladoras



▶ CEPILLOS CÓNICOS ACERO LATONADO ALAMBRE ONDULADO 50815

REF.	€	8 41 4299	g	A mm	B mm	C mm	L1 mm	L2 mm	RPM max
50815-1001	16,43	374520	12	180	100	100	30	20	12500
50815-1002	30,62	374568	12	260	100	100	40	20	12500

Alambre ondulado 0,30 mm diámetro.



▶ CEPILLOS CÓNICOS ACERO INOXIDABLE ALAMBRE ONDULADO 50816

REF.	€	8 41 4299	g	A mm	B mm	C mm	L1 mm	L2 mm	RPM max
50816-1001	34,40	374605	12	180	100	100	30	20	12500
50816-1002	51,79	374643	12	260	100	100	40	20	12500

Alambre ondulado 0,30 mm diámetro.



▶ CEPILLOS CÓNICOS ACERO TEMPLADO ALAMBRE TRENZADO 50817

REF.	€	8 41 4299	g	A mm	B mm	C mm	L1 mm	L2 mm	RPM max
50817-1001	17,27	374681	12	210	100	100	30	20	12500
50817-1151	20,12	374728	12	270	110	110	35	20	12500



▶ CEPILLOS CÓNICOS ACERO INOXIDABLE ALAMBRE TRENZADO 50817-I

REF.	€	8 41 4299	g	A mm	B mm	C mm	L1 mm	L2 mm	RPM max
50817-1001 I	37,78	633818	12	210	100	100	33	20	12500

Alambre ondulado 0,30 mm diámetro.



▶ CEPILLO INDUSTRIAL BROCHA ACERO LATONADO ALAMBRE ONDULADO 50818

REF.	€	8 41 4299	g	A mm	B mm	C mm	L1 mm	L2 mm	RPM max
50818-25	5,94	686708	24	60	25	25	76	30	20000



▶ CEPILLOS BROCHA ACERO INOXIDABLE ALAMBRE ONDULADO 50818-I

REF.	€	8 41 4299	g	A mm	B mm	C mm	L1 mm	L2 mm	RPM max
50818-25I	9,84	633757	24	60	25	25	76	30	20000

Alambre ondulado 0,30 mm diámetro. Perno de 6 mm.

## CEPILLOS INDUSTRIALES NYLON

- Fabricados con filamentos de nylon de gran flexibilidad que evita su rotura, con granos de abrasivo SiC.
- Dos tipos de grano:
  - Color rojo, 80 grano basto (B).
  - Color azul, 180 grano fino (F).
- Con espiga de 6 mm, para fijación en taladros standard



▶ CEPILLO CIRCULAR NYLON 50825

REF.	€	8 41 4299	g	A mm	B mm	C mm	L1 mm	L2 mm	RPM max	
50825-100B	8,48	375329	12	90	100	100	40	23	10	4500
50825-75B	7,00	375244	24	70	75	75	40	16	10	4500

Perno de 6 mm.



▶ CEPILLO CIRCULAR NYLON 50825

REF.	€	8 41 4299	g	A mm	B mm	C mm	L1 mm	L2 mm	RPM max	
50825-75F	7,33	375602	24	70	75	75	40	16	10	4500
50825-100F	8,82	375282	12	90	100	100	40	23	10	4500

Perno de 6 mm.



▶ CEPILLO TAZA NYLON 50826

REF.	€	8 41 4299	g	A mm	B mm	C mm	L1 mm	L2 mm	RPM max	
50826-75B	7,33	375480	24	100	75	75	72	25	75	4500
50826-50B	6,85	375404	24	50	50	50	65	18	50	4500

Perno de 6 mm.



▶ CEPILLO TAZA NYLON 50826

REF.	€	8 41 4299	g	A mm	B mm	C mm	L1 mm	L2 mm	RPM max	
50826-50F	7,00	375367	24	50	50	50	65	18	50	4500
50826-75F	7,56	375442	24	100	75	75	73	25	75	4500

Perno de 6 mm.



▶ CEPILLO BROCHA NYLON 50827

REF.	€	8 41 4299	g	A mm	B mm	C mm	L1 mm	L2 mm	RPM max	
50827-25B	5,61	375565	24	40	25	25	70	25	25	4500

Perno de 6 mm.



▶ CEPILLO BROCHA NYLON 50827

REF.	€	8 41 4299	g	A mm	B mm	C mm	L1 mm	L2 mm	RPM max	
50827-25F	5,84	375527	24	40	25	25	70	25	25	4500

Perno de 6 mm.



▶ CEPILLO ABANICO NYLON 50829

REF.	€	8 41 4299	g	A mm	B mm	C mm	L1 mm	L2 mm	RPM max	
50829-100B	9,04	961034	12	70	100	100	55	25	100	3500



▶ CEPILLO ABANICO NYLON 50829

REF.	€	8 41 4299	g	A mm	B mm	C mm	L1 mm	L2 mm	RPM max	
50829-100F	9,04	961072	12	70	100	100	50	25	100	3500

# SUJECCIÓN

## TORNILLO DE BANCO

- Fabricados con Acero Especial Bellota.
- Mordazas tratadas térmicamente y moleteadas para garantizar un mejor agarre.
- Amplio yunque que proporciona una mayor superficie de trabajo.
- Apoyo sobre guía cuadrada, mayor estabilidad.
- Muy robustos.

### Usos:

- Para trabajos de sujeción, amarre y fijación de piezas o perfiles.

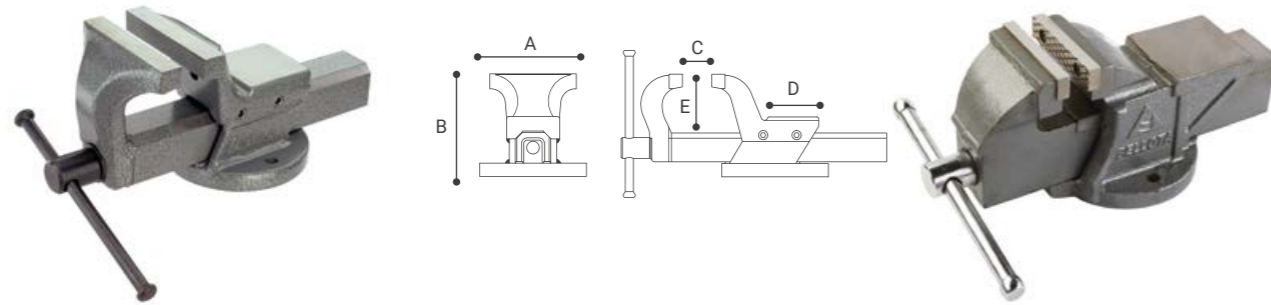

### ▶ TORNILLO DE BANCO FORJADO 6700

REF.	€	8 41 4299	g	A mm	B mm	C mm	L mm
6700-100	237,03	026313	1	6.580	122	300	125
6700-125	335,75	026337	1	9.790	140	355	150
6700-150	433,18	019872	1	16.390	162	456	200
6700-175	579,03	019858	1	25.670	200	515	220

### ▶ TORNILLO DE BANCO FUNDIDO 6710

REF.	€	8 41 4299	g	A mm	B mm	C mm	L mm
6710-80	76,14	365375	1	5.220	109	266	175
6710-100	107,49	353419	1	6.080	110	275	177
6710-125	139,61	353457	1	11.350	135	340	190
6710-150	181,26	353488	1	14.750	159	395	220

## SARGENTOS

- Cabeza de fundición nodular.
- Llanta de acero calibrada y dentada, protegida frente a la oxidación.
- Freno antideslizante en cabeza móvil.
- Superficie de fijación plana.

### Usos:

- Para trabajos de sujeción, amarre, fijación de piezas y perfiles.



### ▶ SARGENTO MARQUETERÍA 51200

REF.	€	8 41 4299	g	A mm	B mm	C mm	L1 mm	L2 mm
51200-15	13,02	215236	10	530	25	90	220	150
51200-20	13,79	215298	10	570	25	100	270	200
51200-25	14,90	215366	10	610	25	95	320	250
51200-30	15,66	215434	10	680	25	106	370	300

Mango madera.



### ▶ SARGENTO MARQUETERÍA 51201

REF.	€	8 41 4299	g	A mm	B mm	C mm	L1 mm	L2 mm
51201-15	13,02	215564	12	500	20	95	220	150
51201-20	13,79	215632	12	550	20	95	270	200
51201-25	14,90	215694	12	590	20	95	320	250
51201-30	15,66	215755	12	650	20	95	380	300

Mango en cruz.



### ▶ SARGENTO PROFESIONAL 51210

REF.	€	8 41 4299	g	A mm	B mm	C mm	L1 mm	L2 mm
51210-25	24,03	215960	12	1.410	140	25	350	90
51210-30	25,52	216035	14	1.500	140	28	400	90
51210-40	28,78	216097	14	1.680	140	30	500	90
51210-50	31,68	216165	12	1.870	140	28	600	90
51210-60	34,35	216233	12	2.050	140	30	700	90
51210-80	39,24	216295	10	2.400	140	28	900	90

Mango madera.



### ▶ SARGENTO PROFESIONAL EXTRA DE ÉMBOLO 51215

REF.	€	8 41 4299	g	A mm	B mm	C mm	L1 mm	L2 mm
51215-30	25,87	216561	14	1.760	30	142	400	90
51215-40	29,23	216639	14	1.920	28	145	502	90
51215-50	31,82	216691	12	2.090	26	145	602	90
51215-60	34,80	216752	12	2.240	140	25	700	90
51215-80	39,41	216813	10	2.610	140	23	900	90

Mango en cruz.



### ▶ SARGENTO PROFESIONAL EXTRA DE ÉMBOLO 51225

REF.	€	8 41 4299	g	A mm	B mm	C mm	L1 mm	L2 mm
51225-35	29,56	217490	12	2.320	180	34	470	120
51225-40	31,00	217568	12	2.490	185	34	523	120
51225-50	33,47	217636	10	2.630	185	34	610	120
51225-60	36,05	217698	8	2.840	180	34	720	120
51225-80	41,24	217766	8	3.260	185	34	915	120
51225-100	46,38	217834	6	3.720	180	34	1.120	1000

Mango en cruz.



# LIMAS Y ESCOFINAS

- Fabricadas con Acero Especial Bellota.
- Forjadas en una sola pieza, irrompibles.
- Tratamiento térmico 3+ para alargar la vida útil de la herramienta: no se rompe, no se deforma, no se desgasta.
- Nivel de dureza estudiado para cada lima en función del trabajo a realizar para conseguir la máxima duración.
- Dentado uniforme en función del tipo de picado para obtener el mejor resultado.
- Posibilidad de incorporar mango Bimaterial ergonómico con acabado SOFT TOUCH para mayor comodidad durante el trabajo.

## MECÁNICO

- Para trabajos de repasado, afilado, raspado y acabado en talleres mecánicos e industria en general.

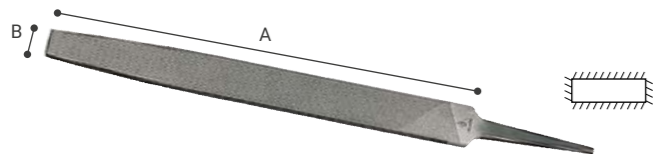

### ► LIMA PLANA PUNTA 4001

REF.	€	8 41 4299	g	A mm	B mm	M
4001-4 BAS.	7,05	400106	12 25 100	7,9-11,2	4089-2/4090-2/4093-B4	
4001-4 ENT.	7,35	400304	12 25 100	7,9-11,2	4089-2/4090-2/4093-B4	
4001-4 FIN.	8,10	400502	12 25 100	7,9-11,2	4089-2/4090-2/4093-B4	
4001-6 BAS.	8,07	400700	12 70 150	10,5-15,1	4089-4/4090-3/4093-B3	
4001-6 ENT.	8,45	400908	12 70 150	10,5-15,1	4089-4/4090-3/4093-B3	
4001-6 FIN.	9,38	401301	12 70 150	10,5-15,1	4089-4/4090-3/4093-B3	
4001-8 BAS.	10,43	401509	12 150 200	13,3-19,2	4089-7/4090-4/4093-A4	
4001-8 ENT.	10,86	401707	12 150 200	13,3-19,2	4089-7/4090-4/4093-A4	
4001-8 FIN.	11,93	402100	12 150 200	13,3-19,2	4089-7/4090-4/4093-A4	
4001-10 BAS.	14,65	402308	12 271 250	16-24,4	4090-5/4093-A2	
4001-10 ENT.	15,08	402506	12 271 250	16-24,4	4090-5/4093-A2	
4001-10 FIN.	16,46	402704	12 271 250	16-24,4	4090-5/4093-A2	
4001-12 BAS.	19,62	402902	6 463 300	19-29	4090-6/4093-A2	
4001-12 ENT.	20,43	403107	6 463 300	19-29	4090-6/4093-A2	
4001-12 FIN.	21,90	403305	6 463 300	19-29	4090-6/4093-A2	
4001-14 BAS.	23,77	403503	6 720 350	22,5-34	4090-6/4093-A1	
4001-14 ENT.	25,04	403701	6 720 350	22,5-34	4090-6/4093-A1	
4001-14 FIN.	26,56	403909	6 720 350	22,5-34	4090-6/4093-A1	

Lima plana. Dos caras.



### ► LIMA PLANA PUNTA MANGO BIMATERIAL 4001

REF.	€	8 41 4299	g	A mm	B mm	M
4001-4 BAS. MB	9,44	097818	6 63 100	7,9-11,2	4093-B4	
4001-4 ENT. MB	9,61	093650	6 63 100	7,9-11,2	4093-B4	
4001-6 BAS. MB	10,23	093865	6 125 150	10,5-15,1	4093-B3	
4001-6 ENT. MB	10,87	093759	6 125 150	10,5-15,1	4093-B3	
4001-6 FIN. MB	12,26	098051	6 125 150	10,5-15,1	4093-B3	
4001-8 BAS. MB	11,98	098242	6 220 200	13,3-19,2	4093-A4	
4001-8 ENT. MB	12,99	098549	6 220 200	13,3-19,2	4093-A4	
4001-8 FIN. MB	13,69	098679	6 220 200	13,3-19,2	4093-A4	
4001-10 BAS. MB	16,88	131666	6 353 250	16-24,4	4093-A2	
4001-10 ENT. MB	16,61	099171	6 353 250	16-24,4	4093-A2	
4001-10 FIN. MB	18,17	099294	6 353 250	16-24,4	4093-A2	

Lima plana. Dos caras.



### ► LIMA PLANA PARALELA 4002

REF.	€	8 41 4299	g	A mm	B mm	M
4002-4 BAS.	7,27	404203	12 27 100	11,2	4089-2 / 4090-2 / 4093-B4	
4002-4 ENT.	7,35	404401	12 27 100	11,2	4089-2 / 4090-2 / 4093-B4	
4002-4 FIN.	7,89	404609	12 27 100	11,2	4089-2 / 4090-2 / 4093-B4	
4002-6 BAS.	8,32	404807	12 75 150	15,1	4089-4 / 4090-3 / 4093-B3	
4002-6 ENT.	8,45	405002	12 75 150	15,1	4089-4 / 4090-3 / 4093-B3	
4002-6 FIN.	9,38	405200	12 75 150	15,1	4089-4 / 4090-3 / 4093-B3	
4002-8 BAS.	10,75	405606	12 156 200	19,2	4089-7 / 4090-4 / 093-A4	
4002-8 ENT.	10,86	405804	12 156 200	19,2	4089-7 / 4090-4 / 4093-A4	
4002-8 FIN.	11,93	406009	12 156 200	19,2	4089-7 / 4090-4 / 4093-A4	
4002-10 BAS.	14,65	406207	12 279 250	24,4	4090-5 / 4093-A2	
4002-10 ENT.	15,52	406405	12 279 250	24,4	4090-5 / 4093-A2	
4002-10 FIN.	16,46	406603	12 279 250	24,4	4090-5 / 4093-A2	
4002-12 BAS.	19,62	406801	6 476 300	29	4090-6 / 4093-A2	
4002-12 ENT.	20,43	407006	6 476 300	29	4090-6 / 4093-A2	
4002-12 FIN.	21,90	407204	6 476 300	29	4090-6 / 4093-A2	
4002-14 BAS.	23,77	407402	6 750 350	34	4090-6 / 4093-A1	
4002-14 ENT.	25,04	407600	6 750 350	34	4090-6 / 4093-A1	

Lima plana. Tres caras.



### ► LIMA MEDIACAÑA 4003

REF.	€	8 41 4299	g	A mm	B mm	M
4003-4 BAS.	10,99	408102	12 18 100	8,9-10,6	4089-2 / 4090-2 / 4093-B4	
4003-4 ENT.	11,30	408300	12 18 100	8,9-10,6	4089-2 / 4090-2 / 4093-B4	
4003-4 FIN.	12,14	408508	12 18 100	8,9-10,6	4089-2 / 4090-2 / 4093-B4	
4003-6 BAS.	11,78	408706	12 53 150	12,7-15	4089-4 / 4090-3 / 4093-B3	
4003-6 ENT.	12,32	408904	12 53 150	12,7-15	4089-4 / 4090-3 / 4093-B3	
4003-6 FIN.	13,23	409307	12 53 150	12,7-15	4089-4 / 4090-3 / 4093-B3	
4003-8 BAS.	13,72	409505	12 123 200	14,8-19,8	4089-7 / 4090-4 / 4093-A4	
4003-8 ENT.	14,66	409703	12 123 200	14,8-19,8	4089-7 / 4090-4 / 4093-A4	
4003-8 FIN.	16,09	410105	12 123 200	14,8-19,8	4089-7 / 4090-4 / 4093-A4	
4003-10 BAS.	19,25	410303	12 230 250	19-24	4090-5 / 4093-A3	
4003-10 ENT.	20,01	410501	12 230 250	19-24	4090-5 / 4093-A3	
4003-10 FIN.	21,82	410709	12 230 250	19-24	4090-5 / 4093-A3	
4003-12 BAS.	25,73	410907	6 385 300	19,5-28,5	4090-6 / 4093-A2	
4003-12 ENT.	26,69	411102	6 385 300	19,5-28,5	4090-6 / 4093-A2	
4003-12 FIN.	28,81	411300	6 385 300	19,5-28,5	4090-6 / 4093-A2	
4003-14 BAS.	31,60	411508	6 586 350	23-33,2	4090-6 / 4093-A1	
4003-14 ENT.	33,31	411706	6 586 350	23-33,2	4090-6 / 4093-A1	

Lima mediacaña.



### ► LIMA REDONDA 4004

REF.	€	8 41 4299	g	A mm	B mm	M
4004-4 BAS.	6,59	412109	12 10 100	2-3,8	4089-1 / 4090-1 / 4093-B5	
4004-4 ENT.	6,70	412307	12 10 100	2-3,8	4089-1 / 4090-1 / 4093-B5	
4004-4 FIN.	7,17	412505	12 10 100	2-3,8	4089-1 / 4090-1 / 4093-B5	
4004-6 BAS.	8,32	413304	12 29 150	3,5-5,8	4089-2 / 4090-2 / 4093-B4	
4004-6 ENT.	8,37	413502	12 29 150	3,5-5,8	4089-2 / 4090-2 / 4093-B4	
4004-6 FIN.	8,92	413908	12 29 150	3,5-5,8	4089-2 / 4090-2 / 4093-B4	
4004-8 BAS.	9,55	414103	12 73 200	5-7,5	4089-3 / 4090-3 / 4093-B4	
4004-8 ENT.	9,85	414301	12 73 200	5-7,5	4089-3 / 4090-3 / 4093-B4	
4004-8 FIN.	10,94	414707	12 73 200	5-7,5	4089-3 / 4090-3 / 4093-B4	
4004-10 BAS.	13,23	414905	12 143 250	6-9,4	4089-4 / 4090-4 / 4093-B3	
4004-10 ENT.	13,46	415100	12 143 250	6-9,4	4089-4 / 4090-4 / 4093-B3	
4004-10 FIN.	14,70	415308	12 143 250	6-9,4	4089-4 / 4090-4 / 4093-B3	
4004-12 BAS.	17,06	415506	6 278 300	7-11,4	4089-4 / 4090-4 / 4093-B3	
4004-12 ENT.	18,11	415704	6 278 300	7-11,4	4089-4 / 4090-4 / 4093-B3	
4004-12 FIN.	19,14	415902	6 278 300	7-11,4	4089-4 / 4090-4 / 4093-B3	

Lima redonda.



### ► LIMA PLANA PARALELA MANGO BIMATERIAL 4002

REF.	€	8 41 4299	g	A mm	B mm	M
4002-4 BAS. MB	9,61	109986	6 67 100	11,2	4093-B4	
4002-4 ENT. MB	9,68	110043	6 67 100	11,2	4093-B4	
4002-6 BAS. MB	10,40	111064	6 130 150	15,1	4093-B3	
4002-6 ENT. MB	10,23	120585	6 130 150	15,1	4093-B3	
4002-6 FIN. MB	11,18	131741	6 130 150	15,1	4093-B3	
4002-8 BAS. MB	12,33	131819	6 223 200	19,2	4093-A4	
4002-8 ENT. MB	12,75	131871	6 223 200	19,2	4093-A4	
4002-8 FIN. MB	13,69	131932	6 223 200	19,2	4093-A4	
4002-10 BAS. MB	16,54	109900	6 392 250	24,4	4093-A2	
4002-10 ENT. MB	17,08	109962	6 392 250	24,4	4093-A2	
4002-10 FIN. MB	18,17	132045	6 392 250	24,4	4093-A2	

Lima plana. Tres caras.



### ► LIMA MEDIACAÑA MANGO BIMATERIAL 4003

REF.	€	8 41 4299	g	A mm	B mm	M
4003-4 BAS. MB	13,00	132465	6 57 100	8,9-10,6	4093-B4	
4003-4 ENT. MB	13,08	132526	6 57 100	8,9-10,6	4093-B4	
4003-4 FIN. MB	13,69	132588	6 57 100	8,9-10,6	4093-B4	
4003-6 BAS. MB	13,45	132656	6 103 150	12,7-15	4093-B3	
4003-6 ENT. MB	14,82	132724	6 103 150	12,7-15	4093-B3	
4003-6 FIN. MB	15,57	132786	6 103 150	12,7-15	4093-B3	
4003-8 BAS. MB	15,88	132847	6 173 200	14,8-19,8	4093-A4	
4003-8 ENT. MB	17,85	132915	6 173 200	14,8-19,8	4093-A4	
4003-8 FIN. MB	18,89	132977	6 173 200	14,8-19,8	4093-A4	
4003-10 BAS. MB	21,53	133042	6 283 250	19-24	4093-A3	
4003-10 ENT. MB	21,68	133110	6 283 250	19-24	4093-A3	
4003-10 FIN. MB	23,27	133172	6 283 250	19-24	4093-A3	

Lima mediacaña.



### ► LIMA REDONDA MANGO BIMATERIAL 4004

REF.	€	8 41 4299	g	A mm	B mm	M
4004-4 BAS. MB	8,68	133769	6 40 100	2-3,8	4093-B5	
4004-4 ENT. MB	8,64	133820	6 40 100	2-3,8	4093-B5	
4004-4 FIN. MB	8,95	133868	6 40 100	2-3,8	4093-B5	
4004-6 BAS. MB	10,27	133929	6 75 150	3,5-5,8	4093-B4	
4004-6 ENT. MB	10,23	133998	6 75 150	3,5-5,8	4093-B4	
4004-6 FIN. MB	10,82	134070	6 75 150	3,5-5,8	4093-B4	
4004-8 BAS. MB	11,38	134124	6 135 200	5-7,5	4093-B4	
4004-8 ENT. MB	11,55	134193	6 135 200	5-7,5	4093-B4	
4004-8 FIN. MB	12,55	134278	6 135 200	5-7,5	4093-B4	
4004-10 BAS. MB	15,21	134346	6 203 250	6-9,4	4093-B3	
4004-10 ENT. MB	15,09	134414	6 203 250	6-9,4	4093-B3	
4004-10 FIN. MB	16,54	134476	6 203 250	6-9,4	4093-B3	

Lima redonda.

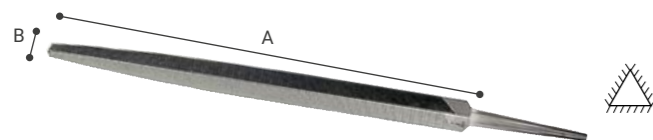

► LIMA TRIANGULAR 4005

REF.	€	8 41 4299	g	A mm	B mm	M
4005-4 BAS.	7,04	416800	12	22	100	5,5-8,5 4089-2/4090-1/4093-B4
4005-4 ENT.	7,27	417005	12	22	100	5,5-8,5 4089-2/4090-1/4093-B4
4005-4 FIN.	7,79	417203	12	22	100	5,5-8,5 4089-2/4090-1/4093-B4
4005-6 BAS.	9,43	418002	12	77	150	8-12,5 4089-3/4090-3/4093-B3
4005-6 ENT.	9,78	418200	12	77	150	8-12,5 4089-3/4090-3/4093-B3
4005-6 FIN.	10,75	418606	12	77	150	8-12,5 4089-3/4090-3/4093-B3
4005-8 BAS.	11,88	418903	12	160	200	10,5-15,6 4089-4/4090-4/4093-B2
4005-8 ENT.	12,54	419108	12	160	200	10,5-15,6 4089-4/4090-4/4093-B2
4005-8 FIN.	13,39	419405	12	160	200	10,5-15,6 4089-4/4090-4/4093-B2
4005-10 BAS.	17,06	419603	12	285	250	11-17,8 4089-7/4090-5/4093-B1
4005-10 ENT.	18,21	419801	12	285	250	11-17,8 4089-7/4090-5/4093-B1
4005-10 FIN.	19,48	420005	12	285	250	11-17,8 4089-7/4090-5/4093-B1
4005-12 BAS.	23,02	420203	6	450	300	12,5-20,6 4090-6/4093-B1
4005-12 ENT.	24,21	420401	6	450	300	12,5-20,6 4090-6/4093-B1
4005-12 FIN.	25,82	420609	6	450	300	12,5-20,6 4090-6/4093-B1

Lima triangular.



► LIMA CUADRADA 4006

REF.	€	8 41 4299	g	A mm	B mm	M
4006-4 BAS.	8,48	422009	12	13	100	1,6-3,8 4089-1/4090-1/4093-B5
4006-4 ENT.	8,63	422207	12	13	100	1,6-3,8 4089-1/4090-1/4093-B5
4006-4 FIN.	8,82	422405	12	13	100	1,6-3,8 4089-1/4090-1/4093-B5
4006-6 BAS.	9,54	423204	12	39	150	2,9-5,4 4089-2/4090-2/4093-B4
4006-6 ENT.	9,84	423402	12	39	150	2,9-5,4 4089-2/4090-2/4093-B4
4006-6 FIN.	10,52	423600	12	39	150	2,9-5,4 4089-2/4090-2/4093-B4
4006-8 BAS.	10,94	423907	12	91	200	4,5-7,1 4089-3/4090-3/4093-B4
4006-8 ENT.	11,32	424102	12	91	200	4,5-7,1 4089-3/4090-3/4093-B4
4006-8 FIN.	12,14	424300	12	91	200	4,5-7,1 4089-3/4090-3/4093-B4
4006-10 BAS.	14,39	424508	12	180	250	5,6-9 4089-4/4090-4/4093-B3
4006-10 ENT.	15,52	424706	12	180	250	5,6-9 4089-4/4090-4/4093-B3
4006-12 BAS.	19,48	425109	6	313	300	6,6-11,6 4089-4/4090-4/4093-B2
4006-12 ENT.	20,29	425307	6	313	300	6,6-11,6 4089-4/4090-4/4093-B2
4006-12 FIN.	21,75	425505	6	313	300	6,6-11,6 4089-4/4090-4/4093-B2

Lima cuadrada.



► LIMA PLANA DELGADA 4007

REF.	€	8 41 4299	g	A mm	B mm	M
4007-6 BAS.	10,99	426908	12	30	150	1,8-15,6 4089-4/4090-3/4093-B3
4007-6 ENT.	11,32	427103	12	30	150	1,8-15,6 4089-4/4090-3/4093-B3
4007-6 FIN.	11,78	427301	12	30	150	1,8-15,6 4089-4/4090-3/4093-B3

Lima plana. Cuatro caras.



► LIMA TRIANGULAR MANGO BIMATERIAL 4005

REF.	€	8 41 4299	g	A mm	B mm	M
4005-4 ENT. MB	8,96	134728	6	60	100	5,5-8,5 4093-B4
4005-6 BAS. MB	11,34	134797	6	127	150	8-12,5 4093-B3
4005-6 ENT. MB	11,55	134872	6	127	150	8-12,5 4093-B3
4005-6 FIN. MB	12,33	134940	6	127	150	8-12,5 4093-B3
4005-8 BAS. MB	13,69	135015	6	225	200	10,5-15,6 4093-B2
4005-8 ENT. MB	13,84	135077	6	225	200	10,5-15,6 4093-B2
4005-8 FIN. MB	15,21	135145	6	225	200	10,5-15,6 4093-B2
4005-10 BAS. MB	18,74	135282	6	357	250	11-17,8 4093-B1
4005-10 ENT. MB	19,50	135350	6	357	250	11-17,8 4093-B1
4005-10 FIN. MB	20,82	135428	6	357	250	11-17,8 4093-B1

Lima triangular.



► LIMA CUADRADA MANGO BIMATERIAL 4006

REF.	€	8 41 4299	g	A mm	B mm	M
4006-4 BAS. MB	10,50	135688	6	43	100	1,6-3,8 4093-B5
4006-4 ENT. MB	10,60	135756	6	43	100	1,6-3,8 4093-B5
4006-4 FIN. MB	10,77	135824	6	43	100	1,6-3,8 4093-B5
4006-6 BAS. MB	11,91	135848	6	77	150	2,9-5,4 4093-B4
4006-6 ENT. MB	11,98	135916	6	77	150	2,9-5,4 4093-B4
4006-6 FIN. MB	12,33	136081	6	77	150	2,9-5,4 4093-B4
4006-8 BAS. MB	13,47	135978	6	140	200	4,5-7,1 4093-B4
4006-8 ENT. MB	13,85	136043	6	140	200	4,5-7,1 4093-B4
4006-8 FIN. MB	13,90	136234	6	140	200	4,5-7,1 4093-B4
4006-10 BAS. MB	16,35	136296	6	243	250	5,6-9 4093-B3
4006-10 ENT. MB	17,08	136357	6	243	250	5,6-9 4093-B3
4006-10 FIN. MB	18,36	136425	6	243	250	5,6-9 4093-B3

Lima cuadrada.

AGUJA

• Para trabajos de relojería, joyería y grabación

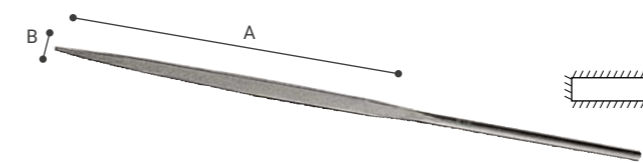

► LIMA PLANA PUNTA 4071

REF.	€	8 41 4299	g	A mm	B mm	
4071-16 BAS.	8,69	444506	12	8	92	5,96
4071-16 ENT.	8,69	444902	12	8	92	5,96
4071-16 FIN.	8,69	445107	12	8	92	5,96

Lima plana. Cuatro caras.



► LIMA MEDIACAÑA 4074

REF.	€	8 41 4299	g	A mm	B mm	
4074-16 BAS.	14,11	446906	12	9	92	5,5
4074-16 ENT.	14,11	447309	12	9	92	5,5
4074-16 FIN.	14,11	447507	12	9	92	5,5

Lima mediacaña.



► LIMA PLANA PARALELA 4076

REF.	€	8 41 4299	g	A mm	B mm	
4076-16 BAS.	8,69	448702	12	9	92	6
4076-16 ENT.	8,69	449105	12	9	92	6
4076-16 FIN.	8,69	449303	12	9	92	6

Lima plana. Cuatro caras.



► JUEGO LIMAS AGUJA 4077

REF.	€	8 41 4299	g	A mm	B mm	C mm	
4077-16	104,57	466201	1	150	170	45	20
4071-16 BAS				4071-16 FIN		4072-16 BAS	
4072-16 FIN				4073-16 BAS		4073-16 FIN	
4074-16 BAS				4074-16 FIN		4075-16 BAS	
4075-16 FIN				4076-16 BAS		4076-16 FIN	



► LIMA REDONDA 4072

REF.	€	8 41 4299	g	A mm	B mm	
4072-16 BAS.	7,30	445305	12	9	92	2,92
4072-16 ENT.	7,30	445701	12	9	92	2,92
4072-16 FIN.	7,30	445909	12	9	92	2,92

Lima redonda.



► LIMA TRIANGULAR 4075

REF.	€	8 41 4299	g	A mm	B mm	
4075-16 BAS.	8,24	447903	12	9	92	3,5
4075-16 ENT.	8,24	448306	12	9	92	3,5
4075-16 FIN.	8,24	448504	12	9	92	3,5

Lima triangular.



► JUEGO LIMAS AGUJA 4078

REF.	€	8 41 4299	g	A mm	B mm	C mm	
4078-16	52,34	466300	1	60	190	120	7
4071-16 BAS				4072-16 BAS		4073-16 BAS	
4074-16 BAS				4075-16 BAS		4076-16 BAS	

## ESCOFINAS MADERA

• Para trabajos en carpintería de madera.

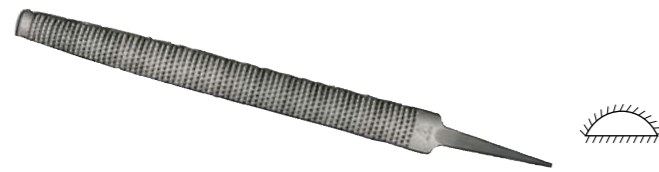

▶ ESCOFINA MEDIACAÑA CARPINTERO 4101

REF.	€	8 41 4299	g	A mm	B mm	M
4101-6 BAS.	17,58	453805	12	59	150	15
4101-6 ENT.	17,59	454000	12	59	150	15
4101-6 FIN.	18,70	454208	12	59	150	14
4101-8 BAS.	19,56	454406	12	119	200	19,5
4101-8 ENT.	20,58	454604	12	119	200	19,5
4101-8 FIN.	25,01	454802	12	119	200	19,5
4101-10 BAS.	23,06	455007	12	229	250	24
4101-10 ENT.	26,70	455205	12	229	250	24
4101-10 FIN.	31,56	455403	12	229	250	24
4101-12 BAS.	27,58	455601	6	375	300	28,5
4101-12 ENT.	31,17	455809	6	375	300	28,5
4101-12 FIN.	36,63	456004	6	375	300	28,5

Lima mediacaña.



▶ ESCOFINA MEDIACAÑA EBANISTA 4102

REF.	€	8 41 4299	g	A mm	B mm	M
4102-6 ENT.	17,65	456400	12	59	150	19
4102-8 BAS.	19,18	457001	12	59	150	19
4102-8 ENT.	20,78	457209	12	121	200	24
4102-10 BAS.	23,06	457803	12	121	200	24
4102-10 ENT.	25,09	458008	12	121	250	29

Lima mediacaña.



▶ ESCOFINA PLANA PUNTA 4103

REF.	€	8 41 4299	g	A mm	B mm	M
4103-8 ENT.	21,20	459708	12	154	200	20

Lima plana. Cuatro caras.



▶ ESCOFINA REDONDA 4104

REF.	€	8 41 4299	g	A mm	B mm	M
4104-6 BAS.	9,21	461008	12	29	150	6
4104-6 ENT.	10,24	461206	12	29	150	6
4104-8 ENT.	13,72	462005	12	71	200	8
4104-10 BAS.	15,45	462609	12	71	200	8
4104-10 ENT.	17,03	462807	12	143	250	10

Lima redonda.



▶ ESCOFINA MEDIACAÑA CARPINTERO MANGO BIMATERIAL 4101

REF.	€	8 41 4299	g	A mm	B mm	M
4101-6 BAS. MB	19,99	136487	6	107	150	15
4101-6 ENT. MB	19,85	137583	6	107	150	15
4101-8 BAS. MB	22,51	137637	6	177	200	19,5
4101-8 ENT. MB	23,78	137699	6	177	200	19,5
4101-10 BAS MB	25,62	137767	6	290	250	24
4101-10 ENT MB	28,11	137835	6	290	250	24

Lima mediacaña.



▶ ESCOFINA MEDIACAÑA EBANISTA MANGO BIMATERIAL 4102

REF.	€	8 41 4299	g	A mm	B mm	M
4102-6 BAS. MB	20,24	138023	6	123	150	19
4102-6 ENT. MB	19,99	138085	6	123	150	19
4102-8 BAS. MB	22,22	138146	6	192	200	24
4102-8 ENT. MB	24,57	138214	6	192	200	24
4102-10 BAS MB	25,33	138276	6	300	250	29
4102-10 ENT MB	27,24	138337	6	300	250	29

Lima mediacaña.



▶ ESCOFINA PLANA PUNTA MANGO BIMATERIAL 4103

REF.	€	8 41 4299	g	A mm	B mm	M
4103-8 ENT. MB	23,73	086133	6	237	200	20

Lima plana. Cuatro caras.



▶ ESCOFINA REDONDA MANGO BIMATERIAL 4104

REF.	€	8 41 4299	g	A mm	B mm	M
4104-6 BAS. MB	12,23	138436	6	75	150	6
4104-6 ENT. MB	12,91	138498	6	75	150	6
4104-8 ENT. MB	16,04	138610	6	138	200	8
4104-10 BAS MB	17,87	138658	6	200	250	10
4104-10 ENT MB	19,38	138702	6	200	250	10

Lima redonda.

## ESCOFINAS Y LIJADORAS PLACA

## ESCOFINAS:

- Hoja de acero al carbono templado y revenido: Máxima duración y vida útil.
- Cuerpo metálico muy resistente.
- Paso de los filos de las hojas de 4,6 mm: acabado rápido y fino.

## Usos:

- Para desbaste o ajuste del corte de placas de yeso laminado.

## LIJADORA:

- Material ABS con base de goma de caucho para mejor adaptación a la superficie a lijar.
- Equipada con lija grano 100: lijado rápido y buen acabado.
- Diseño del mango adaptado al uso y usuario: muy ergonómica.
- Incorpora sistema de cambio rápido de las lijas.
- Muy ligera y resistente.

## Usos:

- Para el lijado de juntas y otras zonas enlucidas.



▶ ESCOFINA METÁLICA 4107-140

REF.	€	8 41 4299	g	A mm	B mm	C mm
4107-140	13,77	561340	6	190	42	150



▶ ESCOFINA METÁLICA 4107-260

REF.	€	8 41 4299	g	A mm	B mm	C mm
4107-260	23,66	561364	6	380	45	280



▶ LIJADORA MANUAL 50272

REF.	€	8 41 4299	g	A mm	B mm	C mm
50272	14,02	564624	2	342	78	80

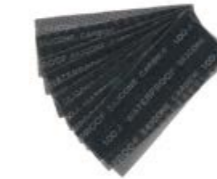

▶ LIJAS PARA LIJADORA MANUAL 50273

REF.	€	8 41 4299	g	A mm	B mm	C mm
50273	10,75	565195	5	203	107	315



▶ HOJA REPUESTO ESCOFINA METÁLICA H4107-140

REF.	€	8 41 4299	g	A mm	B mm	C mm
H4107-140	6,80	563573	10	30	13	42

Se sirven en pack de 2 unidades.



▶ HOJA REPUESTO ESCOFINA METÁLICA H4107-260

REF.	€	8 41 4299	g	A mm	B mm	C mm
H4107-260	7,78	563603	10	40	13	42

Se sirven en pack de 2 unidades.



***Siéntete libre.***  
*Pisa seguro.*

Soluciones  
para protegerte  
cuando más lo necesitas

**PARA  
TU SEGURIDAD**

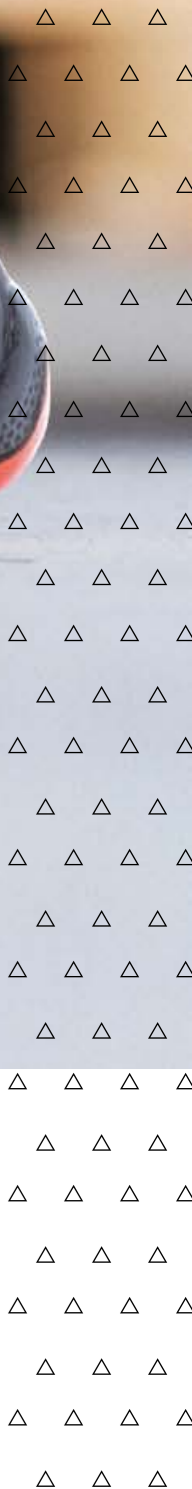

# CALZADO

1

## ► Pensados para ti:

Diferentes modelos para cada tipo de uso. Se adaptan a tu pie y a tus necesidades.

2

## ► Más confortables:

Interior acolchado, cómodo y flexible. No notarás que los llevas puestos.

3

## ► No resbalan:

Con suela SR antideslizamiento. Aportan seguridad y resistencia extra. Pisa fuerte y alcanza tus metas.

## CARACTERÍSTICAS

- Trabaja seguro con nuestro calzado de uso profesional.
- Botas y zapatos antideslizantes, resistentes al agua, a aceites y hidrocarburos, con puntera reforzada, plantilla antiperforación... Pon tus pies a salvo con Bellota.

## USOS

Calzado para todo tipo de usos:

- Para almacenes
- Para el transporte
- Para la industria
- Para la construcción
- Para la agricultura

## CATEGORÍAS DE SEGURIDAD

### 20345:2012

<b>SB</b>	Calzado con puntera resistente a 200 J.
<b>A</b>	Calzado antiestático.
<b>E</b>	Absorción de energía en el talón.
<b>FO</b>	Resistencia a aceites e hidrocarburos.
<b>P</b>	Resistencia a la perforación no inferior a 1100N.
<b>WRU</b>	Resistencia a la absorción y penetración de agua.
<b>WR</b>	Calzado resistente al agua.
<b>HRO</b>	Suela resistente al calor por contacto.
<b>HI</b>	Suela aislante frente al calor del piso.
<b>CI</b>	Suela aislante frente al frío del piso.
<b>SRA</b>	Máxima resistencia al deslizamiento en suelo de cerámica con lubricante: agua con detergente.
<b>SRC</b>	Máxima resistencia al deslizamiento (suelo de cerámica con lubricante: agua con detergente y suelo de acero inoxidable con lubricante: glicerina).
<b>ESD</b>	Desvía la descarga electrostática acumulada en el cuerpo hacia el exterior, evitando dañar los componentes electrónicos (UNE EN 61340-5-1:2016).
<b>S1P</b>	SB + A + E + FO + zona talón cerrado + P.
<b>S3</b>	S1P + WRU + Suela con resaltes.
<b>S5</b>	SB + A + E + FO + P + Suela con resaltes.

### 20345:2022

<b>SB</b>	Calzado con puntera resistente a 200 J.
<b>A</b>	Calzado antiestático.
<b>E</b>	Absorción de energía en el talón.
<b>FO</b>	Resistencia a aceites e hidrocarburos.
<b>P</b>	Resistencia a la perforación metálica no inferior a 1100N.
<b>PL</b>	Resistencia a la perforación TEXTIL no inferior a 1100N con una punta de 4,5mm
<b>PS</b>	Resistencia a la perforación TEXTIL no inferior a 1100N con una punta de 3 mm
<b>WPA</b>	Resistencia a la absorción y penetración de agua.
<b>WR</b>	Calzado resistente al agua.
<b>HRO</b>	Suela resistente al calor por contacto.
<b>HI</b>	Suela aislante frente al calor del piso.
<b>CI</b>	Suela aislante frente al frío del piso.
<b>SR</b>	Máxima resistencia al deslizamiento en suelo de cerámica con glicerina. Test en tacón y tenar.
<b>ESD</b>	Desvía la descarga electrostática acumulada en el cuerpo hacia el exterior, evitando dañar los componentes electrónicos (UNE EN 61340-5-1:2016).
<b>S1P/PL/PS</b>	SB + A + E + zona talón cerrado + P/PL/PS.
<b>S2</b>	SB + A + E + zona talón cerrado
<b>S3/PL/PS</b>	S1P/PL/PS + WPA + Suela con resaltes.
<b>S5/PL/PS</b>	SB + A + E + P/PL/PS + Suela con resaltes.
<b>S7/PL/PS</b>	S3P/PL/PS + WR

# NUESTRO CALZADO

GAMA	REF.	CATEGORÍA DE SEGURIDAD 2012	CATEGORÍA DE SEGURIDAD 2022	PUNTERA	PLANTILLA ANTIPERFORCIÓN	
CLASSIC	72305S1P	S1P (SB A E FO P) SRC	S1P (SB A E P WPA) FO SR	Metálica	Metálica	
	72304S1P	S1P (SB A E FO P) SRC	S1P (SB A E P WPA) FO SR	Metálica	Metálica	
	72306S1P	S1P (SB A E FO P) SRC	S1P (SB A E P WPA) FO SR	Metálica	Metálica	
	72301S3	S3 (SB A E FO P WRU) SRC	S3 (SB A E P WPA) FO SR	Metálica	Metálica	
	72300S3	S3 (SB A E FO P WRU) SRC	S3 (SB A E P WPA) FO SR	Metálica	Metálica	
	72302S3	S3 (SB A E FO P WRU) SRC	S3 (SB A E P WPA) FO SR	Metálica	Metálica	
	72303S3	S3 (SB A E FO P WRU) SRC	S3 (SB A E P WPA) FO SR	Metálica	Metálica	
	72301LNTS3	S3 (SB A E FO P WRU) HRO HI CI SRC	S3 (SB A E P WPA) FO SR HRO HI CI	Metálica	Metálica	
	72300LNTS3	S3 (SB A E FO P WRU) HRO HI CI SRC	S3 (SB A E P WPA) FO SR HRO HI CI	Metálica	Metálica	
	72310S1P	S1P (SB A E FO P) SRC	S1PS (SB A E PS WPA) FO SR	Fibra vidrio	Textil	
COMP+	72312S1P	S1P (SB A E FO P) SRC	S1PS (SB A E PS WPA) FO SR	Fibra vidrio	Textil	
	72309S1P	S1P (SB A E FO P) SRC	S1PS (SB A E PS WPA) FO SR	Fibra vidrio	Textil	
	72310NTS1P	S1P (SB A E FO P) HRO HI CI SRC	S1PS (SB A E PS WPA) FO SR HRO HI CI	Fibra vidrio	Textil	
	72309NTS1P	S1P (SB A E FO P) HRO HI CI SRC	S1PS (SB A E PS WPA) FO SR HRO HI CI	Fibra vidrio	Textil	
	72308S3	S3 (SB A E FO P WRU) SRC	S3S (SB A E PS WPA) FO SR	Fibra vidrio	Textil	
	72307S3	S3 (SB A E FO P WRU) SRC	S3S (SB A E PS WPA) FO SR	Fibra vidrio	Textil	
	72311S3	S3 (SB A E FO P WRU) SRC	S3S (SB A E PS WPA) FO SR	Fibra vidrio	Textil	
	72307GJS3	S3 (SB A E FO P WRU) SRC	S3S (SB A E PS WPA) FO SR	Fibra vidrio	Textil	
	72307NJS3	S3 (SB A E FO P WRU) SRC	S3S (SB A E PS WPA) FO SR	Fibra vidrio	Textil	
	72308GJS3	S3 (SB A E FO P WRU) SRC	S3S (SB A E PS WPA) FO SR	Fibra vidrio	Textil	
NON METAL	72308NJS3	S3 (SB A E FO P WRU) SRC	S3S (SB A E PS WPA) FO SR	Fibra vidrio	Textil	
	72309GJS1P	S1P (SB A E FO P) SRC	S1PS (SB A E PS WPA) FO SR	Fibra vidrio	Textil	
	72310GJS1P	S1P (SB A E FO P) SRC	S1PS (SB A E PS WPA) FO SR	Fibra vidrio	Textil	
	72226S1P	S1P (SB A E FO P) SRC	-	Fibra vidrio	Textil	
	72227S1P	S1P (SB A E FO P) SRC	-	Fibra vidrio	Textil	
	72221S1P	S1P (SB A E FO P) SRC	-	Fibra vidrio	Textil	
	CLICK	72213S3	S3 (SB A E FO P WRU) SRC	S3S (SB A E PS WPA) FO SR	Fibra vidrio	Textil
	AGRO	FTW01B02	O2 (OB A E WRU) WR SRA	-	-	-
		FTW01BS3	S3 (SB A E FO P WRU) WR SRA	S7S (SB A E WR P WPA) FO SR HRO HI CI	Fibra vidrio	Textil
	ALLTRACK	72320MNS3	S3 (SB A E FO P WRU) SRC	S3S (SB A E PS WPA) FO SR	Fibra vidrio	Textil
72321MNS3		S3 (SB A E FO P WRU) SRC	S3S (SB A E PS WPA) FO SR CI	Fibra vidrio	Textil	
FLEX	FTW02BS1P	S1P (SB A E FO P) SRC	S1PS (SB A E PS WPA) FO SR	Fibra vidrio	Textil	
	FTW04GS1P	S1P (SB A E FO P) SRC ESD	S1PS (SB A E PS WPA) FO SR - ESD	Fibra vidrio	Textil	
	FTW05BOS1P	S1P (SB A E FO P) SRC ESD	S1PS (SB A E PS WPA) FO SR - ESD	Fibra vidrio	Textil	
	FTW05BYS1P	S1P (SB A E FO P) SRC ESD	S1PS (SB A E PS WPA) FO SR - ESD	Fibra vidrio	Textil	
	FTW03BS3	S3 (SB A E FO P WRU) SRC ESD	S3S (SB A E PS WPA) FO SR - ESD	Fibra vidrio	Textil	
STREET	FTW07BS3	S3 (SB A E FO P WRU) SRC ESD	-	Fibra vidrio	Textil	
	72350BBS1P	S1P (SB A E FO P) HRO CI SRC	-	Aluminio	Textil	
	72350BRS1P	S1P (SB A E FO P) HRO CI SRC	-	Aluminio	Textil	
INDUSTRY	72351BS1P	S1P (SB A E FO P) HRO CI SRC	-	Aluminio	Textil	
	72352BS1P	S1P (SB A E FO P) HRO CI SRC	-	Aluminio	Textil	
	RUNAS3S	-	S3S (SB A E PS WPA) FO SR CI - ESD	Fibra vidrio	Textil	
RUNNING	RUNBS3S	-	S3S (SB A E PS WPA) FO SR CI - ESD	Fibra vidrio	Textil	
	RUNJS3S	-	S3S (SB A E PS WPA) FO SR CI - ESD	Fibra vidrio	Textil	
	RUNNS3S	-	S3S (SB A E PS WPA) FO SR CI - ESD	Fibra vidrio	Textil	
	72224KBS1P	S1P (SB A E FO P) SRC	-	Fibra vidrio	Textil	
	72224NBS1P	S1P (SB A E FO P) SRC	-	Fibra vidrio	Textil	
	72223BS3	S3 (SB A E FO P WRU) SRC	-	Fibra vidrio	Textil	
	72223NBS3	S3 (SB A E FO P WRU) SRC	-	Fibra vidrio	Textil	
CORE	FTW3050S1P	S1P (SB A E FO P) SRC	S1PS (SB A E PS WPA) FO SR	Acero	Textil	
	FTW4091S1P	S1P (SB A E FO P) SRC	S1PS (SB A E PS WPA) FO SR	Fibra vidrio	Textil	
	FTW4051S3	S3 (SB A E FO P WRU) SRC	S3S (SB A E PS WPA) FO SR	Fibra vidrio	Textil	
RACE	FTW5074S3	S3 (SB A E FO P WRU) SRC	S3S (SB A E PS WPA) FO SR	Fibra vidrio	Textil	
	72323CGS2	S2 (SB A E FO WRU) SRC	S2 (SB A E WPA) FO SR	Metálica	-	
CHEF	72324CGS2	S2 (SB A E FO WRU) SRC	S2 (SB A E WPA) FO SR	Metálica	-	
	72325NNS2	S2 (SB A E FO WRU) SRC	S2 (SB A E WPA) FO SR	Metálica	-	
	72326NNS2	S2 (SB A E FO WRU) SRC	S2 (SB A E WPA) FO SR	Metálica	-	
	72242S5	S5 (SB A E FO P WR) SRA	S5 (SB A E P WR) FO SR.	Metálica	Metálica	
AGUA	72243S5	S5 (SB A E FO P WR) SRA	S5 (SB A E P WR) FO SR.	Metálica	Metálica	
	72241B	OB SRA	-	-	-	

# GAMA RUNNING

1  
2  
3

## Durabilidad

Nuestro tejido FORTITEX™, con tecnología anti-abrasión en combinación con los refuerzos delanteros, traseros y laterales, proporcionan a esta gama una durabilidad sin igual.

## Confort Avanzado

La tecnología Open Cell PRO y la plantilla PU+GEL de este calzado te proporcionará una absorción de impactos, estabilidad y confort superiores. Para que después de la jornada no te sientas fatigado.

## Made in Spain

100% Desarrollado y fabricado en España con la última generación de proceso de fabricación.

### USOS



### CATEGORÍA DE SEGURIDAD



## DESCUBRE LA GAMA RUNNING



### CARACTERÍSTICAS



## MÁS COMODIDAD PLANTILLA GEL

### Open CELL + GEL

Célula abierta y memoria elástica para absorber impactos y recuperar su forma.

### AeroFlow

Máxima transpirabilidad para un calzado fresco, seco y confortable.



## MÁS DURABILIDAD CAUCHO ANTI-ABRASIÓN

Refuerzos delanteros, traseros y laterales en las zonas donde ocurren la mayor parte de los roces y golpes, nos permite otorgar al calzado un mayor grado de protección y durabilidad.



## TECNOLOGÍAS

### FORTITEX™

Mayor resistencia y durabilidad gracias a la inclusión de la segunda generación de la combinación de microfibras con hilos de poliuretano.

### OPEN CELL

Es una tecnología de fabricación desarrollada por Bellota basada en la inclusión de micro-partículas de aire en la composición junto con una nueva generación de poliuretano para



conseguir la máxima ligereza y amortiguación en su calzado.

# GAMA CLASSIC

- Calzado certificado en Categoría II según norma EN ISO 20345.
- Puntera de seguridad y plantilla antiperforación metálicas.

## Suela:

- SRC/SR bidensidad PU + PU: máxima prestación antideslizamiento certificable según normativa ISO 20345.
- Diseño de suela que aporta seguridad y resistencia: canales anchos, zonas de frenado, absorción de impactos, enfranque texturizado y perfiles elevados en puntera y trasera.

## Suela versiones nitrilo:

- Suela de nitrilo cosida al corte para las condiciones más extremas sin renunciar a la comodidad: resistente al calor por contacto (HRO), aislante frente al calor de la suela (HI), aislante frente al frío del piso (CI) y SRC máxima prestación antideslizamiento certificable según normativa ISO 20345
- Diseño de suela que aporta seguridad y resistencia: canales anchos, zonas de frenado, absorción de impactos, enfranque texturizado y perfiles elevados en puntera y trasera.

## Corte:

- Versiones S1P en piel serraje afelpada: más transpirable y ligero.
- Versiones S3P en piel hidrofugada resistente frente a la humedad.
- Collarín acolchado, lengüeta en fieltro.
- Forro acolchado Bellota Mesh: mejor ventilación y mayor comodidad.
- Horma ancha.

## Usos:

- Para uso general en trabajos que necesiten calzado de seguridad. Funcionalidad.

## Usos versiones nitrilo:

- Para uso en las condiciones más extremas que necesiten calzado de seguridad. Funcionalidad.
- Para uso general en trabajos que necesiten calzado de seguridad resistente.
- Almacenaje, transporte, industria y construcción.



► BOTA PIEL S3-72300

REF.	€	8 41 4299	Mbox	
72300-36 S3	32,26	640342	1	10 36
72300-37 S3	32,26	640366	1	10 37
72300-38 S3	32,26	640380	1	10 38
72300-39 S3	32,26	640403	1	10 39
72300-40 S3	32,26	640427	1	10 40
72300-41 S3	32,26	640441	1	10 41
72300-42 S3	32,26	640465	1	10 42
72300-43 S3	32,26	640489	1	10 43
72300-44 S3	32,26	640502	1	10 44
72300-45 S3	32,26	640526	1	10 45
72300-46 S3	32,26	640823	1	10 46
72300-47 S3	32,26	640540	1	10 47
72300-48 S3	32,26	640564	1	10 48

S3 (SB A E FO P WRU) SRC.

\*En recertificación bajo norma 20345:2022 CAT S3 (SB A E P WPA) FO SR.

\*También disponible en versión antihidrólisis: 72300L-S3.



► ZAPATO PIEL S3-72301

REF.	€	8 41 4299	Mbox	
72301-36 S3	31,25	640588	1	10 36
72301-37 S3	31,25	640601	1	10 37
72301-38 S3	31,25	640847	1	10 38
72301-39 S3	31,25	640625	1	10 39
72301-40 S3	31,25	640649	1	10 40
72301-41 S3	31,25	640663	1	10 41
72301-42 S3	31,25	640687	1	10 42
72301-43 S3	31,25	640748	1	10 43
72301-44 S3	31,25	640700	1	10 44
72301-45 S3	31,25	640724	1	10 45
72301-46 S3	31,25	640762	1	10 46
72301-47 S3	31,25	640786	1	10 47
72301-48 S3	31,25	640809	1	10 48

S3 (SB A E FO P WRU) SRC.

\*En recertificación bajo norma 20345:2022 CAT S3 (SB A E P WPA) FO SR.

\*También disponible en versión antihidrólisis: 72301L-S3.



► BOTA SOLDADOR S3-72302

REF.	€	8 41 4299	Mbox	
72302-36 S3	36,71	154054	1	10 36
72302-37 S3	36,71	376210	1	10 37
72302-38 S3	36,71	642148	1	10 38
72302-39 S3	36,71	642162	1	10 39
72302-40 S3	36,71	642186	1	10 40
72302-41 S3	36,71	642209	1	10 41
72302-42 S3	36,71	642223	1	10 42
72302-43 S3	36,71	642247	1	10 43
72302-44 S3	36,71	642261	1	10 44
72302-45 S3	36,71	642285	1	10 45
72302-46 S3	36,71	642308	1	10 46
72302-47 S3	36,71	642322	1	10 47

S3 (SB A E FO P WRU) SRC.

\*En recertificación bajo norma 20345:2022 CAT S3 (SB A E P WPA) FO SR.



► BOTA REFORZADA S3-72303

REF.	€	8 41 4299	Mbox	
72303-36 S3	36,06	642346	1	10 36
72303-37 S3	36,06	642360	1	10 37
72303-38 S3	36,06	643220	1	10 38
72303-39 S3	36,06	642384	1	10 39
72303-40 S3	36,06	642407	1	10 40
72303-41 S3	36,06	642421	1	10 41
72303-42 S3	36,06	643244	1	10 42
72303-43 S3	36,06	642445	1	10 43
72303-44 S3	36,06	642469	1	10 44
72303-45 S3	36,06	642483	1	10 45
72303-46 S3	36,06	642506	1	10 46
72303-47 S3	36,06	642520	1	10 47

S3 (SB A E FO P WRU) SRC.

\*En recertificación bajo norma 20345:2022 CAT S3 (SB A E P WPA) FO SR.



► BOTA SERRAJE S1P-72304

REF.	€	8 41 4299	Mbox	
72304-36 S1P	33,32	642544	1	10 36
72304-37 S1P	33,32	642568	1	10 37
72304-38 S1P	33,32	642582	1	10 38
72304-39 S1P	33,32	642605	1	10 39
72304-40 S1P	33,32	642629	1	10 40
72304-41 S1P	33,32	643268	1	10 41
72304-42 S1P	33,32	642643	1	10 42
72304-43 S1P	33,32	642667	1	10 43
72304-44 S1P	33,32	642681	1	10 44
72304-45 S1P	33,32	642704	1	10 45
72304-46 S1P	33,32	642728	1	10 46
72304-47 S1P	33,32	642742	1	10 47

S1P (SB A E FO P) SRC.

\*En recertificación bajo norma 20345:2022 CAT S1P (SB A E P WPA) FO SR.



► ZAPATO SERRAJE S1P-72305

REF.	€	8 41 4299	Mbox	
72305-36 S1P	31,77	642766	1	10 36
72305-37 S1P	31,77	642780	1	10 37
72305-38 S1P	31,77	642803	1	10 38
72305-39 S1P	31,77	642827	1	10 39
72305-40 S1P	31,77	642841	1	10 40
72305-41 S1P	31,77	642865	1	10 41
72305-42 S1P	31,77	642889	1	10 42
72305-43 S1P	31,77	642902	1	10 43
72305-44 S1P	31,77	642926	1	10 44
72305-45 S1P	31,77	643282	1	10 45
72305-46 S1P	31,77	642940	1	10 46
72305-47 S1P	31,77	642964	1	10 47

S1P (SB A E FO P) SRC.

\*En recertificación bajo norma 20345:2022 CAT S1P (SB A E P WPA) FO SR.



▶ BOTA SERRAJE LONA S1P-72306

▶ BOTA NITRILO S3-72300

REF.	€	8 41 4299	Mbox	
72306-36 S1P	34,10	642988	1	10 36
72306-37 S1P	34,10	643008	1	10 37
72306-38 S1P	34,10	643022	1	10 38
72306-39 S1P	34,10	643046	1	10 39
72306-40 S1P	34,10	643060	1	10 40
72306-41 S1P	34,10	643084	1	10 41
72306-42 S1P	34,10	643107	1	10 42
72306-43 S1P	34,10	643121	1	10 43
72306-44 S1P	34,10	643145	1	10 44
72306-45 S1P	34,10	643169	1	10 45
72306-46 S1P	34,10	643183	1	10 46
72306-47 S1P	34,10	643206	1	10 47

S1P (SB A E FO P) SRC.

\*En recertificación bajo norma 20345:2022 CAT S1P (SB A E P WPA) FO SR.

REF.	€	8 41 4299	Mbox	
72300LNT-36 S3	36,28	046991	1	10 36
72300LNT-37 S3	36,28	705492	1	10 37
72300LNT-38 S3	36,28	086782	1	10 38
72300LNT-39 S3	36,28	086805	1	10 39
72300LNT-40 S3	36,28	682335	1	10 40
72300LNT-41 S3	36,28	682359	1	10 41
72300LNT-42 S3	36,28	682373	1	10 42
72300LNT-43 S3	36,28	682397	1	10 43
72300LNT-44 S3	36,28	682434	1	10 44
72300LNT-45 S3	36,28	682519	1	10 45
72300LNT-46 S3	36,28	682595	1	10 46
72300LNT-47 S3	36,28	682670	1	10 47

S3 (SB A E FO P WRU) HRO HI CI SRC.

\*En recertificación bajo norma 20345:2022 CAT S3 (SB A E P WPA) FO SR HRO HI CI.



▶ ZAPATO NITRILO S3-72301

REF.	€	8 41 4299	Mbox	
72301LNT-36 S3	35,67	047028	1	10 36
72301LNT-37 S3	35,67	047066	1	10 37
72301LNT-38 S3	35,67	682755	1	10 38
72301LNT-39 S3	35,67	682830	1	10 39
72301LNT-40 S3	35,67	682915	1	10 40
72301LNT-41 S3	35,67	682991	1	10 41
72301LNT-42 S3	35,67	683028	1	10 42
72301LNT-43 S3	35,67	683042	1	10 43
72301LNT-44 S3	35,67	683073	1	10 44
72301LNT-45 S3	35,67	683097	1	10 45
72301LNT-46 S3	35,67	683127	1	10 46
72301LNT-47 S3	35,67	683172	1	10 47

S3 (SB A E FO P WRU) HRO HI CI SRC.

\*En recertificación bajo norma 20345:2022 CAT S3 (SB A E P WPA) FO SR HRO HI CI.

## GAMA COMP+

- Calzado certificado en Categoría II según norma EN ISO 20345.
- Puntera de seguridad y plantilla antiperforación no metálicas.

### Suela:

- SRC/SR bidensidad PU + PU: máxima prestación antideslizamiento certificable según normativa ISO 20345.
- Diseño de suela que aporta seguridad y resistencia: canales anchos, zonas de frenado, absorción de impactos, enfranque texturizado y perfiles elevados en puntera y trasera.
- Calzado certificado en Categoría II según norma EN ISO 20345

### Suela versiones nitrilo:

- Suela de nitrilo cosida al corte para las condiciones más extremas sin renunciar a la comodidad: resistente al calor por contacto (HRO), aislante frente al calor del piso (HI), aislante frente al frío del piso (CI) y SRC/SR máxima prestación antideslizamiento certificable según normativa actual.
- Diseño de suela que aporta seguridad y resistencia: canales anchos, zonas de frenado, absorción de impactos, enfranque texturizado y perfiles elevados en puntera y trasera.

### Corte:

- Versiones S1PS en piel serraje afelpada: más transpirable y ligero.
- Versiones S3S en piel hidrofugada resistente frente a la humedad.
- Elementos con prestaciones reflectantes para mayor seguridad.
- Collarín acolchado, lengüeta en fuelle.
- Forro acolchado Bellota Mesh: mejor ventilación y mayor comodidad.
- Horma ancha.

### Usos:

- Para uso general en trabajos que necesiten calzado de seguridad. Flexibilidad y ligereza 100% Non Metal.
- Almacenaje, transporte, industria y construcción.

### Usos versiones nitrilo:

- Para uso en las condiciones más extremas que necesiten calzado de seguridad. Funcionalidad.
- Para uso general en trabajos que necesiten calzado de seguridad resistente.
- Almacenaje, transporte, industria y construcción.



▶ BOTA PIEL NON METAL S3-72307

▶ ZAPATO PIEL NON METAL S3-72308

REF.	€	8 41 4299	Mbox	
72307-36 S3	41,47	042764	1	10 36
72307-37 S3	41,47	042788	1	10 37
72307-38 S3	41,47	645835	1	10 38
72307-39 S3	41,47	645859	1	10 39
72307-40 S3	41,47	645873	1	10 40
72307-41 S3	41,47	645897	1	10 41
72307-42 S3	41,47	645910	1	10 42
72307-43 S3	41,47	645934	1	10 43
72307-44 S3	41,47	645958	1	10 44
72307-45 S3	41,47	645972	1	10 45
72307-46 S3	41,47	645996	1	10 46
72307-47 S3	41,47	646016	1	10 47
72307-48 S3	41,47	042801	1	10 48

S3 (SB A E FO P WRU) SRC.

\*En recertificación bajo norma 20345:2022 CAT S3S (SB A E PS WPA) FO SR.

\*También disponible en versión antihidrólisis: 72307L-S3.

REF.	€	8 41 4299	Mbox	
72308-36 S3	40,29	042863	1	10 36
72308-37 S3	40,29	042887	1	10 37
72308-38 S3	40,29	646030	1	10 38
72308-39 S3	40,29	646054	1	10 39
72308-40 S3	40,29	646078	1	10 40
72308-41 S3	40,29	646092	1	10 41
72308-42 S3	40,29	646115	1	10 42
72308-43 S3	40,29	646139	1	10 43
72308-44 S3	40,29	646153	1	10 44
72308-45 S3	40,29	646177	1	10 45
72308-46 S3	40,29	646191	1	10 46
72308-47 S3	40,29	646214	1	10 47
72308-48 S3	40,29	042900	1	10 48

S3 (SB A E FO P WRU) SRC.

\*En recertificación bajo norma 20345:2022 CAT S3S (SB A E PS WPA) FO SR.

\*También disponible en versión antihidrólisis: 72308L-S3.





BOTA PIEL SOLDADOR S3-72311

REF.	€	8 41 4299	Mbox	
7231138S3	44,29	675511	1	38
7231139S3	44,29	675597	1	39
7231140S3	44,29	675672	1	40
7231141S3	44,29	675757	1	41
7231142S3	44,29	675832	1	42
7231143S3	44,29	675900	1	43
7231144S3	44,29	675955	1	44
7231145S3	44,29	675993	1	45
7231146S3	44,29	676068	1	46
7231147S3	44,29	676105	1	47
7231148S3	44,29	045109	1	48

S3 (SB A E FO P WRU) SRC. \*En recertificación bajo norma 20345:2022 CAT S3S (SB A E PS WPA) FO SR.



ZAPATO SERRAJE NON METAL SIP-72310

REF.	€	8 41 4299	Mbox	
72310-36S1P	41,67	045161	1	36
72310-37S1P	41,67	045574	1	37
72310-38S1P	41,67	646436	1	38
72310-39S1P	41,67	646450	1	39
72310-40S1P	41,67	646474	1	40
72310-41S1P	41,67	646498	1	41
72310-42S1P	41,67	646511	1	42
72310-43S1P	41,67	646535	1	43
72310-44S1P	41,67	646559	1	44
72310-45S1P	41,67	646573	1	45
72310-46S1P	41,67	646597	1	46
72310-47S1P	41,67	646610	1	47
72310-48S1P	41,67	046694	1	48

S1P (SB A E FO P) SRC. \*En recertificación bajo norma 20345:2022 CAT S1PS (SB A E PS WPA) FO SR.



BOTA NITRILLO SIP-72309

REF.	€	8 41 4299	Mbox	
72309NT38S1P	49,59	683257	1	38
72309NT39S1P	49,59	683332	1	39
72309NT40S1P	49,59	683363	1	40
72309NT41S1P	49,59	683394	1	41
72309NT42S1P	49,59	683417	1	42
72309NT43S1P	49,59	683448	1	43
72309NT44S1P	49,59	683479	1	44
72309NT45S1P	49,59	683493	1	45
72309NT46S1P	49,59	683554	1	46
72309NT47S1P	49,59	683578	1	47

S1P (SB A E FO P) SRC HRO HI CI. \*En recertificación bajo norma 20345:2022 CAT S1PS (SB A E PS WPA) FO SR HRO HI CI.



BOTA SERRAJE NON METAL SIP-72309

REF.	€	8 41 4299	Mbox	
72309-36 S1P	42,85	044485	1	36
72309-37 S1P	42,85	045062	1	37
72309-38 S1P	42,85	646238	1	38
72309-39 S1P	42,85	646252	1	39
72309-40 S1P	42,85	646276	1	40
72309-41 S1P	42,85	646290	1	41
72309-42 S1P	42,85	646337	1	42
72309-43 S1P	42,85	646313	1	43
72309-44 S1P	42,85	646351	1	44
72309-45 S1P	42,85	646375	1	45
72309-46 S1P	42,85	646399	1	46
72309-47 S1P	42,85	646412	1	47
72309-48 S1P	42,85	045086	1	48

S1P (SB A E FO P) SRC. \*En recertificación bajo norma 20345:2022 CAT S1PS (SB A E PS WPA) FO SR.



ZAPATO SERRAJE EASY SIP-72312

REF.	€	8 41 4299	Mbox	
7231238S1P	41,25	687224	1	38
7231239S1P	41,25	687248	1	39
7231240S1P	41,25	687262	1	40
7231241S1P	41,25	687286	1	41
7231242S1P	41,25	687309	1	42
7231243S1P	41,25	687323	1	43
7231244S1P	41,25	687347	1	44
7231245S1P	41,25	687361	1	45
7231246S1P	41,25	687385	1	46
7231247S1P	41,25	687408	1	47

S1P (SB A E FO P) SRC. \*En recertificación bajo norma 20345:2022 CAT S1PS (SB A E PS WPA) FO SR.



ZAPATO NITRILLO SIP-72310

REF.	€	8 41 4299	Mbox	
72310NT38S1P	48,99	683608	1	38
72310NT39S1P	48,99	683639	1	39
72310NT40S1P	48,99	683653	1	40
72310NT41S1P	48,99	683714	1	41
72310NT42S1P	48,99	683738	1	42
72310NT43S1P	48,99	683769	1	43
72310NT44S1P	48,99	683813	1	44
72310NT45S1P	48,99	683875	1	45
72310NT46S1P	48,99	683899	1	46
72310NT47S1P	48,99	683929	1	47

S1P (SB A E FO P) SRC HRO HI CI. \*En recertificación bajo norma 20345:2022 CAT S1PS (SB A E PS WPA) FO SR HRO HI CI.



BOTA PIEL NOBUCK S3-72307

REF.	€	8 41 4299	Mbox	
72307GJ S3 38	44,47	713947	1	38
72307GJ S3 39	44,47	713961	1	39
72307GJ S3 40	44,47	713985	1	40
72307GJ S3 41	44,47	714005	1	41
72307GJ S3 42	44,47	714029	1	42
72307GJ S3 43	44,47	714043	1	43
72307GJ S3 44	44,47	714067	1	44
72307GJ S3 45	44,47	714081	1	45
72307GJ S3 46	44,47	714104	1	46
72307GJ S3 47	44,47	714128	1	47

S3 (SB A E FO P WRU) SRC. \*En recertificación bajo norma 20345:2022 CAT S3S (SB A E PS WPA) FO SR.



BOTA PIEL NEGRA S3-72307

REF.	€	8 41 4299	Mbox	
72307NJ S3 38	43,47	714371	1	38
72307NJ S3 39	43,47	714395	1	39
72307NJ S3 40	43,47	714418	1	40
72307NJ S3 41	43,47	714432	1	41
72307NJ S3 42	43,47	714456	1	42
72307NJ S3 43	43,47	714470	1	43
72307NJ S3 44	43,47	714494	1	44
72307NJ S3 45	43,47	714517	1	45
72307NJ S3 46	43,47	714531	1	46
72307NJ S3 47	43,47	714555	1	47

S3 (SB A E FO P WRU) SRC. \*En recertificación bajo norma 20345:2022 CAT S3S (SB A E PS WPA) FO SR.



BOTA SERRAJE GRIS SIP-72309

REF.	€	8 41 4299	Mbox	
72309GJ S1P 38	42,85	713718	1	38
72309GJ S1P 39	42,85	713732	1	39
72309GJ S1P 40	42,85	713756	1	40
72309GJ S1P 41	42,85	713800	1	41
72309GJ S1P 42	42,85	713824	1	42
72309GJ S1P 43	42,85	713848	1	43
72309GJ S1P 44	42,85	713862	1	44
72309GJ S1P 45	42,85	713886	1	45
72309GJ S1P 46	42,85	713909	1	46
72309GJ S1P 47	42,85	713923	1	47

S1P (SB A E FO P) SRC. \*En recertificación bajo norma 20345:2022 CAT S1PS (SB A E PS WPA) FO SR.



ZAPATO PIEL NOBUCK S3-72308

REF.	€	8 41 4299	Mbox	
72308GJ S3 38	43,29	714142	1	38
72308GJ S3 39	43,29	714166	1	39
72308GJ S3 40	43,29	714180	1	40
72308GJ S3 41	43,29	714203	1	41
72308GJ S3 42	43,29	714227	1	42
72308GJ S3 43	43,29	714241	1	43
72308GJ S3 44	43,29	714296	1	44
72308GJ S3 45	43,29	714319	1	45
72308GJ S3 46	43,29	714333	1	46
72308GJ S3 47	43,29	714357	1	47

S3 (SB A E FO P WRU) SRC. \*En recertificación bajo norma 20345:2022 CAT S3S (SB A E PS WPA) FO SR.



ZAPATO PIEL NEGRA S3-72308

REF.	€	8 41 4299	Mbox	
72308NJ S3 38	42,29	714579	1	38
72308NJ S3 39	42,29	714593	1	39
72308NJ S3 40	42,29	714616	1	40
72308NJ S3 41	42,29	714630	1	41
72308NJ S3 42	42,29	714654	1	42
72308NJ S3 43	42,29	714678	1	43
72308NJ S3 44	42,29	714692	1	44
72308NJ S3 45	42,29	714715	1	45
72308NJ S3 46	42,29	714739	1	46
72308NJ S3 47	42,29	714753	1	47

S3 (SB A E FO P WRU) SRC. \*En recertificación bajo norma 20345:2022 CAT S3S (SB A E PS WPA) FO SR.



ZAPATO SERRAJE GRIS SIP-72310

REF.	€	8 41 4299	Mbox	
72310GJ S1P 38	41,67	372885	1	38
72310GJ S1P 39	41,67	713534	1	39
72310GJ S1P 40	41,67	713558	1	40
72310GJ S1P 41	41,67	713572	1	41
72310GJ S1P 42	41,67	713596	1	42
72310GJ S1P 43	41,67	713619	1	43
72310GJ S1P 44	41,67	713633	1	44
72310GJ S1P 45	41,67	713657	1	45
72310GJ S1P 46	41,67	713671	1	46
72310GJ S1P 47	41,67	713695	1	47

S1P (SB A E FO P) SRC. \*En recertificación bajo norma 20345:2022 CAT S1PS (SB A E PS WPA) FO SR.

# GAMA NONMETAL

- Calzado certificado en Categoría II según norma EN ISO 20345.
- Puntera de seguridad y plantilla antiperforación no metálicas.

## Suela:

- SRC/SR bidensidad PU + PU: máxima prestación antideslizamiento certificable según normativa actual.
- Diseño de suela que aporta seguridad y resistencia EXTRA: canales anchos, zonas de frenado, absorción de impactos y perfiles elevados en puntera y trasera.

## Corte:

- Acabado:
  - MODELOS AIR / EASY-Serraje Afelpada: más transpirable y ligera.
- Pieza en TPU en la zona del tobillo para mayor protección y mejor sensación de ajuste.
- Collarín EXTRA acolchado, lengüeta en fuelle EXTRA acolchada y plantilla interior conformada ergonómicamente para mayor comodidad y ajuste.
- Forro EXTRA acolchado Bellota Mesh 3D: mejor ventilación y mayor comodidad.
- Horma EXTRA ancha.
- Corchetes no metálicos: calzado 100% no metálico.

## Usos:

- Para uso general en trabajos que necesiten calzado de seguridad. Flexibilidad y Ligereza. 100% no metálico.



► BOTA AIR S1P-72221

REF.	€	8 41 4299	Mbox		
72221-38 S1P	60,06	353440	1	5	38
72221-39 S1P	60,06	353501	1	5	39
72221-40 S1P	60,06	375640	1	5	40
72221-41 S1P	60,06	375688	1	5	41
72221-42 S1P	60,06	375749	1	5	42
72221-43 S1P	60,06	375787	1	5	43
72221-44 S1P	60,06	375824	1	5	44
72221-45 S1P	60,06	375862	1	5	45
72221-46 S1P	60,06	375909	1	5	46
72221-47 S1P	60,06	375947	1	5	47

S1P (SB A E FO P) SRC.

► ZAPATO AIR S1P-72226

REF.	€	8 41 4299	Mbox		
72226-38 S1P	58,29	375985	1	5	38
72226-39 S1P	58,29	376029	1	5	39
72226-40 S1P	58,29	376067	1	5	40
72226-41 S1P	58,29	376630	1	5	41
72226-42 S1P	58,29	420739	1	5	42
72226-43 S1P	58,29	421781	1	5	43
72226-44 S1P	58,29	421804	1	5	44
72226-45 S1P	58,29	421828	1	5	45
72226-46 S1P	58,29	421842	1	5	46
72226-47 S1P	58,29	422290	1	5	47

S1P (SB A E FO P) SRC.



► ZAPATO EASY S1P-72227

REF.	€	8 41 4299	Mbox		
72227-38 S1P	58,57	425482	1	5	38
72227-39 S1P	58,57	425512	1	5	39
72227-40 S1P	58,57	425536	1	5	40
72227-41 S1P	58,57	425574	1	5	41
72227-42 S1P	58,57	429435	1	5	42
72227-43 S1P	58,57	429459	1	5	43
72227-44 S1P	58,57	429473	1	5	44
72227-45 S1P	58,57	429497	1	5	45
72227-46 S1P	58,57	429527	1	5	46
72227-47 S1P	58,57	429855	1	5	47

S1P (SB A E FO P) SRC.

# GAMA CLICK

- Calzado certificado en Categoría II según norma EN ISO 20345:11.
- Puntera de seguridad y plantilla antiperforación no metálicas.

## Suela:

- SRC/SR bidensidad PU + PU: máxima prestación antideslizamiento certificable según normativa actual.
- Diseño de suela que aporta seguridad y resistencia EXTRA: canales anchos, zonas de frenado, absorción de impactos, enfranque texturizado y perfiles MUY elevados en puntera y trasera.

## Corte:

- Piel Nobuck hidrofugada (S3S): resistente a la penetración y absorción de agua.
- Pieza continua en TPU en la zona del tobillo para mayor protección y mejor sensación de ajuste, y para facilitar el descalce.
- Collarín EXTRA acolchado, lengüeta en fuelle EXTRA acolchada y plantilla interior conformada ergonómicamente para mayor comodidad y ajuste.
- Forro EXTRA acolchado Bellota Mesh 3D: mejor ventilación y mayor comodidad.
- Horma EXTRA ancha.
- Sistema de ajuste exclusivo BELLOTA CLICK que facilita y simplifica el calce y descalce. Tras el ajuste inicial, basta con soltar las pestañas laterales para ajustar y desajustar el calzado.

## Usos:

- Para uso general en trabajos que necesiten calzado de seguridad. Ajuste, flexibilidad y ligereza.
- Especialmente indicado para trabajar en el exterior. Uso OUTDOOR.



► BOTA CLICK S3-72213

REF.	€	8 41 4299	Mbox		
72213-38 S3	77,66	060263	1	5	38
72213-39 S3	77,66	613728	1	5	39
72213-40 S3	77,66	613742	1	5	40
72213-41 S3	77,66	613766	1	5	41
72213-42 S3	77,66	613780	1	5	42
72213-43 S3	77,66	613803	1	5	43
72213-44 S3	77,66	613827	1	5	44
72213-45 S3	77,66	614084	1	5	45
72213-46 S3	77,66	613841	1	5	46
72213-47 S3	77,66	613865	1	5	47

S3 (SB A E FO P WRU) SRC.

\*En recertificación bajo norma 20345:2022 CAT S3S (SB A E PS WPA) FO SR.

# GAMA AGRO

- FTW01BS1P: Calzado certificado acorde al Reglamento (UE) 425/2016. Zapato O2-WR.
- FTW01BS3: Calzado certificado en Categoría II según norma EN ISO 20345:11. Zapato S3-WR.
- Calzado de trabajo con membrana impermeable y costuras selladas.

## Suela:

- Bidensidad Goma+EVA: Goma para conseguir una mayor resistencia térmica, resistencia a hidrocarburos y al deslizamiento.
- EVA para conseguir mayor ligereza y amortiguación.
- Diseño de suela que aporta seguridad y resistencia: canales anchos, zonas de frenado, absorción de impactos y perfiles elevados en puntera y trasera.
- Inserto de TPU en el enfranque para evitar la torsión del pie y dotar de estabilidad a la pisada.

## Corte:

- Piel natural de alta calidad CrazyHorse, resistente y fuerte.
- Pieza en TPU en la zona del tobillo para mayor protección y mejor sensación de ajuste.
- Collarín EXTRA acolchado, lengüeta en fuelle EXTRA acolchada. Plantilla interior conformada de espuma de célula abierta que proporciona un mayor confort y comodidad. Cosido antiestático.
- Forro EXTRA acolchado Bellota Mesh 3D: mejor ventilación y mayor comodidad.
- Horma ancha.
- Puntera antiabrasión para mayor resistencia a golpes y rozaduras.

## Usos:

- FTW01B02: Para uso general en trabajos que necesiten calzado ocupacional sin seguridad (Sin puntera ni plantilla de seguridad).
- Especialmente indicado para trabajar en el exterior y ambientes húmedos: agricultura, jardinería y medio rural, ganadería o minería.
- FTW01BS3: Para uso general en trabajos que necesiten calzado ocupacional con seguridad (con puntera y plantilla de seguridad textil).
- Especialmente indicado para trabajar en el exterior y ambientes húmedos: agricultura, jardinería, ganadería o minería.



► BOTA AGRO O2 WR FTW01

REF.	€	8 41 4299	Mbox	
FTW0138B02	82,47	673654	1	5 38
FTW0139B02	82,47	673678	1	5 39
FTW0140B02	82,47	673746	1	5 40
FTW0141B02	82,47	673760	1	5 41
FTW0142B02	82,47	673791	1	5 42
FTW0143B02	82,47	673814	1	5 43
FTW0144B02	82,47	673838	1	5 44
FTW0145B02	82,47	673869	1	5 45
FTW0146B02	82,47	673906	1	5 46
FTW0147B02	82,47	673920	1	5 47

O2 (OB A E WRU) SRA WR.



► BOTA OUTDOOR WR S3-FTW01

REF.	€	8 41 4299	Mbox	
FTW0138BS3	93,36	691603	1	5 38
FTW0139BS3	93,36	691627	1	5 39
FTW0140BS3	93,36	691641	1	5 40
FTW0141BS3	93,36	691665	1	5 41
FTW0142BS3	93,36	691689	1	5 42
FTW0143BS3	93,36	691702	1	5 43
FTW0144BS3	93,36	691726	1	5 44
FTW0145BS3	93,36	691740	1	5 45
FTW0146BS3	93,36	691764	1	5 46
FTW0147BS3	93,36	691788	1	5 47

S3 (SB A E FO P WRU) SRA HRO HI CI WR.

\*En recertificación bajo norma 20345:2022 CAT S7S (SB A E P WR) FO SR HRO HI CI

# GAMA ALLTRACK

- Calzado certificado en Categoría II según norma EN ISO 20345
- Puntera de seguridad y plantilla antiperforación no metálicas.

## Suela:

- SRC/SR bidensidad PU + PU: Máxima prestación antideslizamiento certificable según normativa actual.
- Diseño de suela que aporta seguridad y resistencia: canales anchos, zonas de frenado, absorción de impactos, enfranque texturizado y perfiles elevados en puntera y trasera.

## Corte:

- Piel natural Brown Smooth Leather resistente a salpicaduras de líquidos, transpirable y fácil de limpiar.
- Pieza de poliuretano en la zona del tobillo para mayor protección y mejor sensación de ajuste.
- Forro interior textil para proteger la zona del empeine.
- Malla interior de espuma que aporta confort y aislamiento.
- Refuerzo de microfibra interior textil para evitar arrugas y brindar mayor comodidad.

## Usos:

- Para uso en condiciones húmedas y/o secas, de uso industrial y/o trabajo. Resistente a la abrasión.
- Recomendado para uso petrolero y minería.



► BOTA ALLTRACK PETROL SIN FORRO S3-72320

REF.	€	8 41 4299	Mbox	
72320MN S3 38	74,00	016185	1	5 38
72320MN S3 39	74,00	016208	1	5 39
72320MN S3 40	74,00	016239	1	5 40
72320MN S3 41	74,00	016253	1	5 41
72320MN S3 42	74,00	016284	1	5 42
72320MN S3 43	74,00	016307	1	5 43
72320MN S3 44	74,00	016338	1	5 44
72320MN S3 45	74,00	016352	1	5 45
72320MN S3 46	74,00	016376	1	5 46
72320MN S3 47	74,00	016390	1	5 47

S3 (SB A E FO P WRU) SRC.

\*En recertificación bajo norma 20345:2022 CAT S3S (SB A E PS WPA) FO SR.



► BOTA ALLTRACK PETROL CON FORRO S3-72321

REF.	€	8 41 4299	Mbox	
72321MN S3 38	76,00	015904	1	5 38
72321MN S3 39	76,00	015966	1	5 39
72321MN S3 40	76,00	015997	1	5 40
72321MN S3 41	76,00	016017	1	5 41
72321MN S3 42	76,00	016031	1	5 42
72321MN S3 43	76,00	016055	1	5 43
72321MN S3 44	76,00	016079	1	5 44
72321MN S3 45	76,00	016109	1	5 45
72321MN S3 46	76,00	016147	1	5 46
72321MN S3 47	76,00	016161	1	5 47

S3 (SB A E FO P WRU) SRC.

\*En recertificación bajo norma 20345:2022 CAT S3S (SB A E PS WPA) FO SR CI.

# GAMA FLEX

- Calzado certificado en Categoría II según norma EN ISO 20345.
- Puntera de seguridad de fibra de vidrio y plantilla textil antiperforación no metálica.
- Zapatos testados biomecánicamente para respetar la pisada natural y aportar un máximo confort en el trabajo.
- Modelos con certificado ESD que desvía la descarga electrostática acumulada en el cuerpo hacia el exterior, evitando dañar los componentes electrónicos.

## Suela:

- SRC/SR bidensidad PU + PU: máxima prestación antideslizamiento certificable según normativa actual.
- Nueva suela que aporta seguridad y máximo confort: zonas de frenado, absorción de impactos, enfranque texturizado máxima flexión.

## Corte:

- Piel o Microfibra + Mesh (en busca de resistencia, ligereza y transpirabilidad) según modelo.
- Forro, collarín y lengüeta tipo fuelle, EXTRA acolchados para una mayor comodidad y mejor ventilación.
- Plantilla interior CONFORT PLUS de espuma de célula abierta que proporciona un mayor confort y disipación de las presiones. Cosido antiestático.
- Puntera y zona trasera antiabrasión para mayor resistencia a golpes y rozaduras.

## Usos:

- Para uso general en trabajos que necesiten calzado de seguridad. Confort, transpirabilidad y ligereza.
- Especialmente indicado para trabajar en reposición, manipulación, industria.
- Modelos certificados ESD, adecuados para trabajos en empresas químicas, en la industria del automóvil o en el ensamblaje de componentes electrónicos.

## Horma:

- Horma y tallaje masculino FTW02, FTW03, FTW04 y FTW05.
- Horma y tallaje femenino FTW07.



► ZAPATO FLEX NEGRO-NARANJA S1P-FTW05

REF.	€	8 41 4299	Mbox	
FTW0538BOS1P	56,39	690163	1	5 38
FTW0539BOS1P	56,39	690187	1	5 39
FTW0540BOS1P	56,39	690200	1	5 40
FTW0541BOS1P	56,39	690224	1	5 41
FTW0542BOS1P	56,39	690248	1	5 42
FTW0543BOS1P	56,39	690262	1	5 43
FTW0544BOS1P	56,39	690286	1	5 44
FTW0545BOS1P	56,39	690309	1	5 45
FTW0546BOS1P	56,39	690323	1	5 46
FTW0547BOS1P	56,39	690347	1	5 47

S1P (SB A E FO P) SRC - ESD.

\*En recertificación bajo norma 20345:2022 CAT S1PS (SB A E PS WPA) FO SR - ESD.



► ZAPATO FLEX AZUL-AMARILLO S1P-FTW05

REF.	€	8 41 4299	Mbox	
FTW0536BYS1P	56,39	074413	1	5 36
FTW0537BYS1P	56,39	074475	1	5 37
FTW0538BYS1P	56,39	690361	1	5 38
FTW0539BYS1P	56,39	690385	1	5 39
FTW0540BYS1P	56,39	690408	1	5 40
FTW0541BYS1P	56,39	690422	1	5 41
FTW0542BYS1P	56,39	690453	1	5 42
FTW0543BYS1P	56,39	690477	1	5 43
FTW0544BYS1P	56,39	690491	1	5 44
FTW0545BYS1P	56,39	690514	1	5 45
FTW0546BYS1P	56,39	690538	1	5 46
FTW0547BYS1P	56,39	690552	1	5 47
FTW0548BYS1P	56,39	074499	1	5 48

S1P (SB A E FO P) SRC - ESD.

\*En recertificación bajo norma 20345:2022 CAT S1PS (SB A E PS WPA) FO SR - ESD.



► ZAPATO FLEX BEIGE S1P-FTW02

REF.	€	8 41 4299	Mbox	
FTW0236BS1P	50,19	074260	1	5 36
FTW0237BS1P	50,19	074291	1	5 37
FTW0238BS1P	50,19	689563	1	5 38
FTW0239BS1P	50,19	689587	1	5 39
FTW0240BS1P	50,19	689600	1	5 40
FTW0241BS1P	50,19	689624	1	5 41
FTW0242BS1P	50,19	689648	1	5 42
FTW0243BS1P	50,19	689662	1	5 43
FTW0244BS1P	50,19	689686	1	5 44
FTW0245BS1P	50,19	689709	1	5 45
FTW0246BS1P	50,19	689723	1	5 46
FTW0247BS1P	50,19	689747	1	5 47
FTW0248BS1P	50,19	074338	1	5 48

S1P (SB A E FO P) SRC.

\*En recertificación bajo norma 20345:2022 CAT S1PS (SB A E PS WPA) FO SR.



► ZAPATO FLEX NEGRO SPORT S1P-FTW04

REF.	€	8 41 4299	Mbox	
FTW0438GS1P	52,97	689969	1	5 38
FTW0439GS1P	52,97	689983	1	5 39
FTW0440GS1P	52,97	690002	1	5 40
FTW0441GS1P	52,97	690026	1	5 41
FTW0442GS1P	52,97	690040	1	5 42
FTW0443GS1P	52,97	690064	1	5 43
FTW0444GS1P	52,97	690088	1	5 44
FTW0445GS1P	52,97	690101	1	5 45
FTW0446GS1P	52,97	690125	1	5 46
FTW0447GS1P	52,97	690149	1	5 47

S1P (SB A E FO P) SRC - ESD.

\*En recertificación bajo norma 20345:2022 CAT S1PS (SB A E PS WPA) FO SR - ESD.



► ZAPATO FLEX NEGRO S3-FTW03

REF.	€	8 41 4299	Mbox	
FTW0338BS3	55,25	689761	1	5 38
FTW0339BS3	55,25	689785	1	5 39
FTW0340BS3	55,25	689808	1	5 40
FTW0341BS3	55,25	689822	1	5 41
FTW0342BS3	55,25	689846	1	5 42
FTW0343BS3	55,25	689860	1	5 43
FTW0344BS3	55,25	689884	1	5 44
FTW0345BS3	55,25	689907	1	5 45
FTW0346BS3	55,25	689921	1	5 46
FTW0347BS3	55,25	689945	1	5 47

S3 (SB A E FO P WRU) SRC - ESD.

\*En recertificación bajo norma 20345:2022 CAT S3S (SB A E PS WPA) FO SR - ESD.



► ZAPATO FLEX FEMENINO NEGRO S3-FTW07

REF.	€	8 41 4299	Mbox	
FTW073590S3	55,25	702620	1	5 35
FTW073690S3	55,25	702644	1	5 36
FTW073790S3	55,25	702668	1	5 37
FTW073890S3	55,25	702682	1	5 38
FTW073990S3	55,25	702705	1	5 39
FTW074090S3	55,25	702729	1	5 40
FTW074190S3	55,25	702743	1	5 41
FTW074290S3	55,25	702767	1	5 42

S3 (SB A E FO P WRU) SRC - ESD.

# GAMA STREET E INDUSTRY

- Calzado certificado acorde al Reglamento (UE) 425/2016. Zapato de seguridad S1P.
- Puntera de seguridad de aluminio amagnético y plantilla textil anti perforación no metálica.

## Suela:

- Bidensidad: Goma + EVA: Goma para conseguir una mayor resistencia térmica a altas temperaturas HRO y con un alto coeficiente antideslizamiento SRC/SR. EVA para conseguir mayor ligereza y amortiguación, absorción de impactos.
- Diseño de suela exclusiva que aporta seguridad, resistente a aceites e hidrocarburos, aislamiento frente al frío (CI).

## Corte:

- Microfibra + Mesh: ultra transpirables.
- Forro, collarín y lengüeta tipo fuelle, EXTRA acolchados para una mayor comodidad y mejor ventilación.
- CI: Interior resistente a bajas temperaturas.
- Plantilla interior conformada de espuma de célula abierta que proporciona un mayor confort y comodidad. Cosido antiestático.
- Puntera y zona trasera anti abrasión para mayor resistencia a golpes y rozaduras.
- Puntera de aluminio amagnética, extra ancha y ligera.
- Mayor ligereza.
- Puntera anti abrasión para mayor resistencia a golpes y rozaduras.

## Usos:

- Para uso general en trabajos que necesiten calzado de seguridad. Confort, transpirabilidad y ligereza.
- Especialmente indicado para trabajar en reposición, manipulación, industria.



▶ ZAPATO STREET NEGRO-AZUL S1P-72350

REF.	€	8 41 4299	Mbox	
72350BB38S1P	71,08	657722	1	5 38
72350BB39S1P	71,08	657746	1	5 39
72350BB40S1P	71,08	657760	1	5 40
72350BB41S1P	71,08	657784	1	5 41
72350BB42S1P	71,08	657807	1	5 42
72350BB43S1P	71,08	657821	1	5 43
72350BB44S1P	71,08	657845	1	5 44
72350BB45S1P	71,08	657869	1	5 45
72350BB46S1P	71,08	657883	1	5 46
72350BB47S1P	71,08	657906	1	5 47

S1P (SB A E FO P) HRO CI SRC. \* HASTA FIN DE EXISTENCIAS.



▶ ZAPATO STREET NEGRO-ROJO S1P-72350

REF.	€	8 41 4299	Mbox	
72350BR36S1P	71,08	657920	1	5 36
72350BR37S1P	71,08	657944	1	5 37
72350BR38S1P	71,08	657968	1	5 38
72350BR39S1P	71,08	656831	1	5 39
72350BR40S1P	71,08	656855	1	5 40
72350BR41S1P	71,08	656770	1	5 41
72350BR42S1P	71,08	656879	1	5 42
72350BR43S1P	71,08	656893	1	5 43
72350BR44S1P	71,08	656916	1	5 44
72350BR45S1P	71,08	656930	1	5 45
72350BR46S1P	71,08	656954	1	5 46
72350BR47S1P	71,08	656978	1	5 47

S1P (SB A E FO P) HRO CI SRC. \* HASTA FIN DE EXISTENCIAS.



▶ ZAPATO INDUSTRY NEGRO S1P-72351

REF.	€	8 41 4299	Mbox	
72351B36S1P	70,50	657678	1	5 36
72351B37S1P	70,50	657692	1	5 37
72351B38S1P	70,50	657272	1	5 38
72351B39S1P	70,50	657296	1	5 39
72351B40S1P	70,50	657319	1	5 40
72351B41S1P	70,50	657333	1	5 41
72351B42S1P	70,50	657357	1	5 42
72351B43S1P	70,50	657371	1	5 43
72351B44S1P	70,50	657395	1	5 44
72351B45S1P	70,50	657418	1	5 45
72351B46S1P	70,50	657432	1	5 46
72351B47S1P	70,50	657456	1	5 47

S1P (SB A E FO P) HRO CI SRC. \* HASTA FIN DE EXISTENCIAS.



▶ ZAPATO INDUSTRY EASY S1P-72352

REF.	€	8 41 4299	Mbox	
72352B38S1P	71,09	657470	1	5 38
72352B39S1P	71,09	657494	1	5 39
72352B40S1P	71,09	657517	1	5 40
72352B41S1P	71,09	657531	1	5 41
72352B42S1P	71,09	657555	1	5 42
72352B43S1P	71,09	657579	1	5 43
72352B44S1P	71,09	657593	1	5 44
72352B45S1P	71,09	657616	1	5 45
72352B46S1P	71,09	657630	1	5 46
72352B47S1P	71,09	657654	1	5 47

S1P (SB A E FO P) HRO CI SRC. \* HASTA FIN DE EXISTENCIAS.



# GAMA RUNNING

## CLASSIC RUN

- Calzado certificado en Categoría II según norma EN ISO 20345:11.
- Puntera de seguridad y plantilla antiperforación no metálicas.

## Suela:

- Bidensidad Goma + EVA: Goma para conseguir una mayor resistencia térmica, resistencia a hidrocarburos y al deslizamiento SRC. EVA para conseguir mayor ligereza y amortiguación.
- Diseño de suela que aporta seguridad y resistencia: canales anchos, zonas de frenado, absorción de impactos.
- Combinación de materiales y últimas tecnologías disponibles para conseguir una suela muy deportiva y ligera.

## Corte:

- Dos líneas de producto:
  - MODELOS RUN: Microfibra Hidrofugada + Printing, S3 resistente a la penetración y absorción de agua.
  - MODELOS CELL: Microfibra hidrofugada S3 resistente a la penetración y absorción de agua + entramado CPU para mayor resistencia.
- Collarín acolchado, lengüeta en fuelle EXTRA acolchada y plantilla interior conformada ergonómicamente para mayor comodidad y ajuste.
- Forro EXTRA acolchado Bellota Mesh 3D: mejor ventilación y mayor comodidad.
- Horma ancha.

## Usos:

- Para uso general en trabajos que necesiten calzado de seguridad. Tecnología y Ligereza.



▶ ZAPATO CELL NEGRO S3-72223

REF.	€	8 41 4299	Mbox	
72223B-38 S3	91,43	637076	1	5 38
72223B-39 S3	91,43	637090	1	5 39
72223B-40 S3	91,43	637113	1	5 40
72223B-41 S3	91,43	637137	1	5 41
72223B-42 S3	91,43	637151	1	5 42
72223B-43 S3	91,43	637458	1	5 43
72223B-44 S3	91,43	637175	1	5 44
72223B-45 S3	91,43	637199	1	5 45
72223B-46 S3	91,43	637212	1	5 46
72223B-47 S3	91,43	637236	1	5 47

S3 (SB A E FO P WRU) SRC.



▶ ZAPATO RUN NEGRO S3-72223NB

REF.	€	8 41 4299	Mbox	
72223NB-38 S3	88,59	654226	1	5 38
72223NB-39 S3	88,59	654240	1	5 39
72223NB-40 S3	88,59	654264	1	5 40
72223NB-41 S3	88,59	654288	1	5 41
72223NB-42 S3	88,59	654301	1	5 42
72223NB-43 S3	88,59	654325	1	5 43
72223NB-44 S3	88,59	654349	1	5 44
72223NB-45 S3	88,59	654363	1	5 45
72223NB-46 S3	88,59	654387	1	5 46
72223NB-47 S3	88,59	654400	1	5 47

S3 (SB A E FO P WRU) SRC. \* HASTA FIN DE EXISTENCIAS.



▶ ZAPATO RUN NEGRO S1P-72224NB

REF.	€	8 41 4299	Mbox	
72224NB-38 S1P	77,71	654660	1	5 38
72224NB-39 S1P	77,71	654684	1	5 39
72224NB-40 S1P	77,71	654707	1	5 40
72224NB-41 S1P	77,71	654721	1	5 41
72224NB-42 S1P	77,71	654745	1	5 42
72224NB-43 S1P	77,71	654769	1	5 43
72224NB-44 S1P	77,71	654783	1	5 44
72224NB-45 S1P	77,71	654806	1	5 45
72224NB-46 S1P	77,71	654820	1	5 46
72224NB-47 S1P	77,71	654844	1	5 47

S1P (SB A E FO P) SRC. \*HASTA FIN DE EXISTENCIAS.



▶ ZAPATO KNIT NEGRO S1P-72224KB

REF.	€	8 41 4299	Mbox	
72224KB-36 S1P	78,33	654622	1	5 36
72224KB-37 S1P	78,33	654646	1	5 37
72224KB-38 S1P	78,33	654424	1	5 38
72224KB-39 S1P	78,33	654448	1	5 39
72224KB-40 S1P	78,33	654462	1	5 40
72224KB-41 S1P	78,33	654486	1	5 41
72224KB-42 S1P	78,33	654509	1	5 42
72224KB-43 S1P	78,33	654523	1	5 43
72224KB-44 S1P	78,33	654547	1	5 44
72224KB-45 S1P	78,33	654561	1	5 45
72224KB-46 S1P	78,33	654585	1	5 46
72224KB-47 S1P	78,33	654608	1	5 47

S1P (SB A E FO P) SRC. \*HASTA FIN DE EXISTENCIAS.



## NEW RUN

- Calzado certificado en Categoría II según norma EN ISO 20345:2022.
- Puntera de seguridad fibra de vidrio y plantilla antiperforación textil de la máxima protección antiperforación.
- Zapatos testados biomecánicamente para respetar la pisada natural y aportar un máximo confort en el trabajo y reducir la fatiga.
- Certificado ESD que desvía la descarga electrostática acumulada en el cuerpo hacia el exterior, evitando dañar los componentes electrónicos.

### Suela:

- Bidesidad PU+PU: Resistencia a hidrocarburos y máxima prestación antideslizamiento SR.
- Nueva suela OPEN CELL PRO que aporta estabilidad y máximo confort: zonas de frenado, absorción de impactos, enfranque texturizado máxima flexión.
- Combinación de materiales y últimas tecnologías disponibles para conseguir una suela muy deportiva y ligera.

### Corte:

- Fortitex™ resistencia anti-corte y durabilidad extraordinaria, manteniendo la flexibilidad y transpirabilidad. Hidrofugado para mantener la humedad a raya.
- Refuerzos de caucho anti-abrasión en la puntera, laterales y parte trasera para resistir los trabajos mas exigentes
  - Collarín ergonómico, acolchado, con lengüeta en fuelle EXTRA acolchada para un ajuste perfecto y cómodo.
- Plantilla confort de nueva generación de PU+GEL para una absorción de impactos y estabilidad óptimos, completamente ventilada para la máxima transpirabilidad.
- Forro EXTRA acolchado Bellota Mesh 3D: mejor ventilación y mayor comodidad.
- Horma ancha.

### Usos:

- Para uso general en trabajos que necesiten calzado de seguridad. Tecnología y Ligereza.
- Modelos certificados ESD, adecuados para trabajos en empresas químicas, en la industria del automóvil o en el ensamblaje de componentes electrónicos.



#### ZAPATO RUN BLANCO S3S-RUNB

REF.	€	8 41 4299	Mbox	
RUNBS3S36	63,00	073683	1	10 36
RUNBS3S37	63,00	073768	1	10 37
RUNBS3S38	63,00	073805	1	10 38
RUNBS3S39	63,00	073836	1	10 39
RUNBS3S40	63,00	073874	1	10 40
RUNBS3S41	63,00	073904	1	10 41
RUNBS3S42	63,00	073928	1	10 42
RUNBS3S43	63,00	073959	1	10 43
RUNBS3S44	63,00	073997	1	10 44
RUNBS3S45	63,00	074048	1	10 45
RUNBS3S46	63,00	074086	1	10 46
RUNBS3S47	63,00	074123	1	10 47
RUNBS3S48	63,00	074161	1	10 48

S3S (SB A E PS WPA) FO SR CI - ESD.

#### ZAPATO RUN NEGRO S3S-RUNN

REF.	€	8 41 4299	Mbox	
RUNNS3S36	63,00	074574	1	10 36
RUNNS3S37	63,00	074598	1	10 37
RUNNS3S38	63,00	074611	1	10 38
RUNNS3S39	63,00	074635	1	10 39
RUNNS3S40	63,00	074659	1	10 40
RUNNS3S41	63,00	074673	1	10 41
RUNNS3S42	63,00	074697	1	10 42
RUNNS3S43	63,00	074758	1	10 43
RUNNS3S44	63,00	074772	1	10 44
RUNNS3S45	63,00	074819	1	10 45
RUNNS3S46	63,00	074987	1	10 46
RUNNS3S47	63,00	074833	1	10 47
RUNNS3S48	63,00	074918	1	10 48

S3S (SB A E PS WPA) FO SR CI - ESD.



#### ZAPATO RUN AMARILLO S3S-RUNA

REF.	€	8 41 4299	Mbox	
RUNAS3S36	63,00	072105	1	10 36
RUNAS3S37	63,00	072150	1	10 37
RUNAS3S38	63,00	072174	1	10 38
RUNAS3S39	63,00	072235	1	10 39
RUNAS3S40	63,00	072280	1	10 40
RUNAS3S41	63,00	073454	1	10 41
RUNAS3S42	63,00	073478	1	10 42
RUNAS3S43	63,00	073508	1	10 43
RUNAS3S44	63,00	073577	1	10 44
RUNAS3S45	63,00	073607	1	10 45
RUNAS3S46	63,00	073621	1	10 46
RUNAS3S47	63,00	073645	1	10 47
RUNAS3S48	63,00	073669	1	10 48

S3S (SB A E PS WPA) FO SR CI - ESD.

#### ZAPATO RUN NARANJA S3S-RUNJ

REF.	€	8 41 4299	Mbox	
RUNJS3S36	63,00	071740	1	10 36
RUNJS3S37	63,00	071764	1	10 37
RUNJS3S38	63,00	071788	1	10 38
RUNJS3S39	63,00	071801	1	10 39
RUNJS3S40	63,00	071825	1	10 40
RUNJS3S41	63,00	071849	1	10 41
RUNJS3S42	63,00	071870	1	10 42
RUNJS3S43	63,00	071917	1	10 43
RUNJS3S44	63,00	071955	1	10 44
RUNJS3S45	63,00	071986	1	10 45
RUNJS3S46	63,00	072044	1	10 46
RUNJS3S47	63,00	072068	1	10 47
RUNJS3S48	63,00	072082	1	10 48

S3S (SB A E PS WPA) FO SR CI - ESD.

# GAMA CORE

- Calzado certificado en Categoría II según norma EN ISO 20345.
- Puntera de seguridad de acero y plantilla antiperforación textil.

## Suela:

- SRC/SR bidensidad PU + PU: máxima prestación antideslizamiento certificable según normativa actual.
- Diseño de suela deportivo que busca el máximo confort.

## Corte:

- Piel serraje ligera y transpirable con perforaciones en los laterales.
- Forro, collarín y lengüeta tipo fuelle acolchados para una mayor comodidad y mejor ventilación.
- Puntera y zona trasera antiabrasión para mayor resistencia a golpes y rozaduras.

## Usos:

- Para uso general en trabajos que necesiten calzado de seguridad, transpirabilidad y ligereza.
- Especialmente indicado para trabajar en entornos interiores o secos del sector construcción.



► ZAPATO CORE S1P-FTW3050

REF.	€	8 41 4299	Mbox	
FTW303650S1P	41,55	700930	1	5 36
FTW303750S1P	41,55	700954	1	5 37
FTW303850S1P	41,55	700978	1	5 38
FTW303950S1P	41,55	700992	1	5 39
FTW304050S1P	41,55	701012	1	5 40
FTW304150S1P	41,55	701036	1	5 41
FTW304250S1P	41,55	701050	1	5 42
FTW304350S1P	41,55	701074	1	5 43
FTW304450S1P	41,55	701098	1	5 44
FTW304550S1P	41,55	701111	1	5 45
FTW304650S1P	41,55	701135	1	5 46
FTW304750S1P	41,55	701159	1	5 47

S1P (SB A E FO P) SRC.

\*En recertificación bajo norma 20345:2022 CAT S1PS (SB A E PS WPA) FO SR.

# GAMA VOLTA

- Calzado certificado en Categoría II según norma EN ISO 20345
- Puntera de seguridad de fibra de vidrio y plantilla textil antiperforación no metálica.

## Suela:

- SRC/SR bidensidad PU + PU: máxima prestación antideslizamiento certificable según normativa actual.
- Diseño de suela deportivo que busca el máximo confort.

## Corte:

- Versión S1PS: Combinación de nylon y microfibra en busca de resistencia, ligereza y transpirabilidad.
- Versión S3S: Piel Nobuck hidrofugada resistente al agua y a la abrasión.
- Forro, collarín y lengüeta tipo fuelle acolchados para una mayor comodidad y mejor ventilación.
- Zona trasera antiabrasión para mayor resistencia a golpes y rozaduras.

## Usos:

- Para uso general en trabajos que necesiten calzado de seguridad. Confort, transpirabilidad y ligereza.
- Amplia gama de sectores e industrias de utilización: ensamblaje de componentes electrónicos.



► ZAPATO VOLTA S1P-FTW4091

REF.	€	8 41 4299	Mbox	
FTW403691S1P	49,01	701418	1	5 36
FTW403791S1P	49,01	701432	1	5 37
FTW403891S1P	49,01	701456	1	5 38
FTW403991S1P	49,01	701470	1	5 39
FTW404091S1P	49,01	701494	1	5 40
FTW404191S1P	49,01	701517	1	5 41
FTW404291S1P	49,01	701531	1	5 42
FTW404391S1P	49,01	701555	1	5 43
FTW404491S1P	49,01	701579	1	5 44
FTW404591S1P	49,01	701593	1	5 45
FTW404691S1P	49,01	701616	1	5 46
FTW404791S1P	49,01	701630	1	5 47

S1P (SB A E FO P) SRC.

\*En recertificación bajo norma 20345:2022 CAT S1PS (SB A E PS WPA) FO SR.

► ZAPATO VOLTA S3-FTW4051

REF.	€	8 41 4299	Mbox	
FTW403651S3	53,27	701654	1	5 36
FTW403751S3	53,27	701678	1	5 37
FTW403851S3	53,27	701692	1	5 38
FTW403951S3	53,27	701715	1	5 39
FTW404051S3	53,27	701739	1	5 40
FTW404151S3	53,27	701753	1	5 41
FTW404251S3	53,27	701777	1	5 42
FTW404351S3	53,27	701791	1	5 43
FTW404451S3	53,27	701814	1	5 44
FTW404551S3	53,27	701838	1	5 45
FTW404651S3	53,27	701852	1	5 46
FTW404751S3	53,27	701876	1	5 47

S3 (SB A E FO P WRU) SRC.

\*En recertificación bajo norma 20345:2022 CAT S3S (SB A E PS WPA) FO SR.

# GAMA RACE

- Calzado certificado en Categoría II según norma EN ISO 20345:11. Zapato de seguridad S3.
- Puntera de seguridad de fibra de vidrio y plantilla textil antiperforación no metálica.

## Suela:

- SRC/SR bidensidad PU + PU: máxima prestación antideslizamiento certificable según normativa actual.
- Diseño de suela moderno y deportivo que combina comodidad y amortiguación.

## Corte:

- Rejilla transpirable con lámina impermeabilizante interior para combinar resistencia al agua y ventilación del pie.
- Forro, collarín y lengüeta tipo fuelle, acolchados para una mayor comodidad y transpirabilidad.
- Plantilla interior CONFORT PLUS de espuma de célula abierta que proporciona un mayor confort y disipación de las presiones. Cosido antiestático.
- Puntera y zona trasera antiabrasión para mayor resistencia a golpes y rozaduras.
- Puntera de fibra de vidrio, mayor ligereza.

## Usos:

- Para uso general en trabajos que necesiten calzado de seguridad. Confort, transpirabilidad y ligereza.
- Especialmente indicado para trabajar en reposición, manipulación, industria.



► ZAPATO RACE S3-FTW5074

REF.	€	8 41 4299	Mbox	
FTW503674S3	58,61	701890	1	5 36
FTW503774S3	58,61	701913	1	5 37
FTW503874S3	58,61	701937	1	5 38
FTW503974S3	58,61	701951	1	5 39
FTW504074S3	58,61	701975	1	5 40
FTW504174S3	58,61	701999	1	5 41
FTW504274S3	58,61	702019	1	5 42
FTW504374S3	58,61	702064	1	5 43
FTW504474S3	58,61	702088	1	5 44
FTW504574S3	58,61	702101	1	5 45
FTW504674S3	58,61	702125	1	5 46
FTW504774S3	58,61	702149	1	5 47

S3 (SB A E FO P WRU) SRC.

\*En recertificación bajo norma 20345:2022 CAT S3S (SB A E PS WPA) FO SR.

# GAMA CHEF

- Calzado certificado en Categoría II según norma EN ISO 20345.
- Puntera de seguridad metálica.

## Suela:

- SRC/SR bidensidad PU + PU: Máxima prestación antideslizamiento certificable según normativa actual.
- Diseño de suela que aporta seguridad y resistencia: canales anchos, zonas de frenado, absorción de impactos, franque texturizado y perfiles elevados en puntera y trasera.
- Calzado certificado en Categoría II según norma EN ISO 20345:11.

## Corte:

- Microfibra hidrofugada resistente y fuerte.
- Refuerzo interior textil gris oscuro.
- Puntera de metálica de acero.

## Usos:

- Para uso en la industria alimentaria, limpieza, laboratorios, sanitario, entre otros.



► ZAPATO CHEF S2-72323

REF.	€	8 41 4299	Mbox	
72323CGS238	30,00	026245	1	10 38
72323CGS239	30,00	026320	1	10 39
72323CGS240	30,00	026474	1	10 40
72323CGS241	30,00	026511	1	10 41
72323CGS242	30,00	026559	1	10 42
72323CGS243	30,00	026597	1	10 43
72323CGS244	30,00	026634	1	10 44
72323CGS245	30,00	026672	1	10 45
72323CGS246	30,00	026719	1	10 46
72323CGS247	30,00	026771	1	10 47

S2 (SB A E FO WRU) SRC.

\*En recertificación bajo norma 20345:2022 CAT S2 (SB A E WPA) FO SR.

► ZAPATO CHEF S2-72324

REF.	€	8 41 4299	Mbox	
72324CGS238	31,00	026818	1	10 38
72324CGS239	31,00	027136	1	10 39
72324CGS240	31,00	027211	1	10 40
72324CGS241	31,00	027297	1	10 41
72324CGS242	31,00	027372	1	10 42
72324CGS243	31,00	027594	1	10 43
72324CGS244	31,00	027655	1	10 44
72324CGS245	31,00	027686	1	10 45
72324CGS246	31,00	027709	1	10 46
72324CGS247	31,00	027730	1	10 47

S2 (SB A E FO WRU) SRC.

\*En recertificación bajo norma 20345:2022 CAT S2 (SB A E WPA) FO SR.



► ZAPATO CHEF S2 72325NN

REF.	€	8 41 4299	Mbox	
72325NNS238	30,00	040869	1	10 38
72325NNS239	30,00	040883	1	10 39
72325NNS240	30,00	040906	1	10 40
72325NNS241	30,00	040920	1	10 41
72325NNS242	30,00	040968	1	10 42
72325NNS243	30,00	040982	1	10 43
72325NNS244	30,00	041002	1	10 44
72325NNS245	30,00	041026	1	10 45
72325NNS246	30,00	041040	1	10 46
72325NNS247	30,00	041064	1	10 47

S2 (SB A E FO WRU) SRC.

\*En recertificación bajo norma 20345:2022 CAT S2 (SB A E WPA) FO SR.

► ZAPATO CHEF S2 72326NN

REF.	€	8 41 4299	Mbox	
72326NNS238	31,00	041088	1	10 38
72326NNS239	31,00	041101	1	10 39
72326NNS240	31,00	041125	1	10 40
72326NNS241	31,00	041149	1	10 41
72326NNS242	31,00	041163	1	10 42
72326NNS243	31,00	041187	1	10 43
72326NNS244	31,00	041200	1	10 44
72326NNS245	31,00	041224	1	10 45
72326NNS246	31,00	041248	1	10 46
72326NNS247	31,00	041262	1	10 47

S2 (SB A E FO WRU) SRC.

\*En recertificación bajo norma 20345:2022 CAT S2 (SB A E WPA) FO SR.



# GAMA AGUA

- Calzado certificado en Categoría II según norma EN ISO 20345.
- Puntera de seguridad y plantilla antiperforación metálicas.
- Corte y suela en PVC.
- Refuerzos extra en puntera y tobillos.
- Zona del talón estriada para facilitar el descalce.

## Usos:

- Para uso general en trabajos que necesiten calzado de seguridad impermeable.



► BOTA PVC VERDE S5-72242

REF.	€	8 41 4299	Mbox	
72242-39 S5	18,15	531862	1	6 39
72242-40 S5	18,15	531886	1	6 40
72242-41 S5	18,15	531909	1	6 41
72242-42 S5	18,15	531923	1	6 42
72242-43 S5	18,15	531947	1	6 43
72242-44 S5	18,15	531961	1	6 44
72242-45 S5	18,15	531985	1	6 45
72242-46 S5	18,15	532005	1	6 46
72242-47 S5	18,15	532029	1	6 47

S5 (SB A E FO P WR) SRC.

\*En recertificación bajo norma 20345:2022 CAT S5 (SB A E P WR) FO SR.



► BOTA PVC NEGRA S5-72243

REF.	€	8 41 4299	Mbox	
72243-39 S5	18,15	532104	1	6 39
72243-40 S5	18,15	532128	1	6 40
72243-41 S5	18,15	532142	1	6 41
72243-42 S5	18,15	532166	1	6 42
72243-43 S5	18,15	532180	1	6 43
72243-44 S5	18,15	532203	1	6 44
72243-45 S5	18,15	532227	1	6 45
72243-46 S5	18,15	532241	1	6 46
72243-47 S5	18,15	532265	1	6 47

S5 (SB A E FO P WR) SRC.

\*En recertificación bajo norma 20345:2022 CAT S5 (SB A E P WR) FO SR.



► BOTA PVC NEGRA OB-72241

REF.	€	8 41 4299	Mbox	
72241B-38 OB	11,97	696448	1	6 38
72241B-39 OB	11,97	687040	1	6 39
72241B-40 OB	11,97	687064	1	6 40
72241B-41 OB	11,97	687088	1	6 41
72241B-42 OB	11,97	687101	1	6 42
72241B-43 OB	11,97	687125	1	6 43
72241B-44 OB	11,97	687149	1	6 44
72241B-45 OB	11,97	687163	1	6 45
72241B-46 OB	11,97	687187	1	6 46
72241B-47 OB	11,97	687200	1	6 47

OB SRA.

# CORDONES



► CORDÓN REDONDO NEGRO 120 CM ACC2090

REF.	€	8 41 4299	A mm
ACC2012090	2,22	708394	1 1.200

Longitud adecuada para calzado de 5-7 pares de ojales.



► CORDÓN REDONDO NEGRO-ROJO 120 CM ACC2092

REF.	€	8 41 4299	A mm
ACC2012092	2,22	708400	1 1.200

Longitud adecuada para calzado de 5-7 pares de ojales.



► CORDÓN OVOIDE NEGRO 120 CM ACC2190

REF.	€	8 41 4299	A mm
ACC2112090	2,22	708417	1 1.200

Longitud adecuada para calzado de 5-7 pares de ojales.



► CORDÓN OVOIDE NEGRO 120 CM ACC2190

REF.	€	8 41 4299	A mm
ACC2112070	2,22	708424	1 1.200

Longitud adecuada para calzado de 5-7 pares de ojales.

# PLANTILLAS

**2x GEL**  
**Open CELL**  
**AeroFlow**

Estabilidad y absorción de impactos superiores

Ligereza, absorción de impactos y recuperación de la forma

Máxima transpirabilidad para un calzado fresco y seco

## TECNOLOGÍAS

Ofrece tecnología avanzada **OPEN CELL** y **doble GEL** para la máxima comodidad del usuario.



▶ PLANTILLA PARA CALZADO MODELO RUN PGEL

REF.	€	8 41 4299	6
PGEL36-38	6,99	076387	10
PGEL39-41	6,99	076424	10
PGEL42-44	6,99	076486	10
PGEL45-48	6,99	076547	10

### Tallas disponibles

Múltiples tamaños disponibles con opción de recorte para lograr un ajuste perfecto.

S 36-38    L 42-44  
M 39-41    XL 45-48

# RODILLERAS



▶ RODILLERA 72803

REF.	€	8 41 4299	6
72803	18,11	639193	6



▶ RODILLERA PROFESIONAL 72805

REF.	€	8 41 4299	1
72805	24,02	281941	1

Relleno de gel.



▶ RODILLERA PROFESIONAL EXTRA 72804

REF.	€	8 41 4299	6
72804	29,80	639179	6

Certificada en categoría I según normativa EN 14404 (Nivel1). Interior en neopreno perforado. Relleno en gel.



# MANGOS PARA LA AGRICULTURA

## Mangos de madera

- Fabricados con madera de primera calidad, con las propiedades más adecuadas al trabajo a realizar.
- Diseño ergonómico adaptado a la geometría de cada herramienta.
- Mangos ligeros y agradables al tacto.
- Perfecto acabado barnizado.



### COMPROMISO CON LA CALIDAD Y EL MEDIO AMBIENTE:

Aquellos mangos cuya madera es de haya cuentan con el Certificado PEFC. Este certificado garantiza que el 100% de la madera utilizada proviene de bosques gestionados correctamente según estrictos requisitos sociales, ambientales y económicos aprobados internacionalmente, al mismo tiempo que se optimizan los recursos forestales a lo largo de todo el proceso de fabricación.



Los mangos de jardín cuentan con la Certificación FSC® – Forest Stewardship Council®, que garantiza que la madera utilizada proviene 100% de montes aprovechados de forma responsable, de acuerdo a unos estándares internacionales que contemplan aspectos ambientales, sociales y económicos, y que definen los niveles mínimos de buena gestión para los bosques de todo el mundo.

Consulte nuestras herramientas certificadas.

## Mangos fibra de carbono

- Fabricados con materiales de última generación.
- Diseño ergonómico adaptado a la geometría de cada herramienta:
  - Formas estudiadas y analizadas según la mano, posición de agarre y uso de cada producto: mayor comodidad, agarre y mejor sensación en la mano.
  - Estrías laterales que refuerzan el efecto antideslizamiento y mejoran el agarre.
  - Fin de carrera diseñado para una mayor sujeción del mango mejorando ergonomía y seguridad.
- Mango irrompible, fabricado en tres materiales diferentes:
  - Núcleo con fibra de carbono para mayor duración y resistencia.
  - Cuerpo de polímero técnico de última generación.
  - Recubrimiento de elastómero TPS para mayor ergonomía.

### Mango ovalado

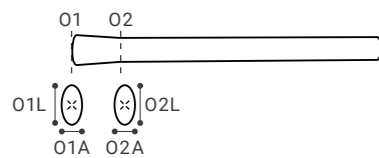

### Mango redondo

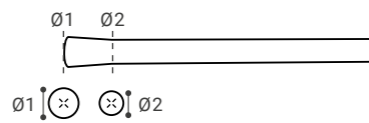

### Mango rectangular

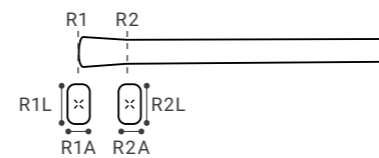

## MANGOS PARA AZADAS BARNIZADOS



### MANGO M1 CON SISTEMA ANTIGIRO

REF.	€	8 41 4299	L mm	Ø1	Ø2	Destino	
HDLM1W1000APH	9,53	697575	6	1.000	32,5	27	Azada M1 con antigiro
HDLM1W1200APH	11,80	697599	6	1.200	32,5	27	Azada M1 con antigiro
HDLM1W1400APH	13,00	697612	6	1.400	32,5	27	Azada M1 con antigiro

### MANGO M4 CON SISTEMA ANTIGIRO

REF.	€	8 41 4299	L mm	Ø1	Ø2	Destino	
HDLM4W1000APH	11,53	697636	6	1.000	41,5	33	Azada M4 con antigiro
HDLM4W1200APH	15,94	697650	6	1.200	41,5	33	Azada M4 con antigiro
HDLM4W1400APH	17,59	697674	6	1.400	41,5	33	Azada M4 con antigiro



### MANGO M6 CON SISTEMA ANTIGIRO

REF.	€	8 41 4299	L mm	Ø1	Ø2	Destino	
HDLM6W1000APH	13,44	697698	6	1.000	46,5	35	Azada M6 con antigiro
HDLM6W1200APH	17,67	697711	6	1.200	46,5	35	Azada M6 con antigiro
HDLM6W1400APH	19,49	697735	6	1.400	46,5	35	Azada M6 con antigiro



### MANGO AZADAS M0

REF.	€	8 41 4299	L mm	Ø1	Ø2	Destino	
M 0-900	8,15	154801	12	900	30	26	Azadas
M 0-1200	9,74	158793	12	1.200	30	26	Azadas



### MANGO AZADAS M2

REF.	€	8 41 4299	L mm	Ø1	Ø2	Destino	
M 2-900	9,13	154207	12	900	35	32	Azadas
M 2-1200	11,67	157871	12	1.200	35	32	Azadas
M 2-1400	12,87	612158	12	1.400	35	32	Azadas



### MANGO AZADAS M4

REF.	€	8 41 4299	L mm	Ø1	Ø2	Destino	
M 4-900	10,05	154405	12	900	41	37	Azadas
M 4-1100	13,88	218343	12	1.100	41	37	Azadas
M 4-1200	13,88	157864	12	1.200	41	37	Azadas
M 4-1400	15,30	612196	12	1.400	41	37	Azadas



### MANGO AZADAS LIGERAS AIR ML

REF.	€	8 41 4299	L mm	Ø1 A	Ø1 L	Ø2 A	Ø2 L	Destino	
ML500	12,06	651980	3	500	36,5	40,5	30	34	L1/L2/L3/L4/L5
ML1200	11,59	651966	3	1.200	36,5	40,5	30	34	L1/L2/L3/L4/L5



### MANGO AZADAS M1

REF.	€	8 41 4299	L mm	Ø1	Ø2	Destino	
M 1-400	5,30	659979	6	400	32	30	228/230/232
M 1-900	8,29	154108	12	900	32	30	Azadas
M 1-1000	9,42	132137	12	1.000	32	30	Azadas
M 1-1200	10,27	158809	12	1.200	32	30	Azadas
M 1-1400	11,31	612134	12	1.400	32	30	Azadas



### MANGO AZADAS M3

REF.	€	8 41 4299	L mm	Ø1	Ø2	Destino	
M 3-900	9,46	154306	12	900	37,5	34	Azadas
M 3-1200	11,75	158816	12	1.200	37,5	34	Azadas
M 3-1400	12,98	612172	12	1.400	37,5	34	Azadas



### MANGO AZADAS M5

REF.	€	8 41 4299	L mm	Ø1	Ø2	Destino	
M 5-900	10,94	154504	12	900	43	39	Azadas
M 5-1200	13,88	157857	12	1.200	43	39	Azadas
M 5-1400	15,30	612219	12	1.400	43	39	Azadas



## ▶ MANGO AZADAS M6

REF.	€	8 41 4299	L mm	Ø1	Ø2	Destino
M 6-900	11,70	154603	12	900	46 42	Azadas / Picachones
M 6-1200	15,38	157840	6	1.200	46 42	Azadas / Picachones
M 6-1400	16,95	612233	6	1.400	46 42	Azadas / Picachones



## ▶ MANGO AZADAS M7

REF.	€	8 41 4299	L mm	Ø1	Ø2	Destino
M 7-900	14,61	154702	6	900	50 45	Azadas / Picachones / Azadones
M 7-1200	18,14	157833	6	1.200	50 45	Azadas / Picachones / Azadones
M 7-1400	20,03	612257	6	1.400	50 45	Azadas / Picachones / Azadones



## ▶ MANGO AZADAS 108

REF.	€	8 41 4299	L mm	O1 A	O1 L	O2 A	O2 L	Destino
M 108	11,67	086331	12	900	35	48	29 41	108



## ▶ MANGO AZADAS 127

REF.	€	8 41 4299	L mm	R1 A	R1 L	R2 A	R2 AL	Destino
M 127	11,67	086355	12	900	30	39	28 34	127



## ▶ MANGO CORTO M 242-A

REF.	€	8 41 4299	L mm	Ø1	Ø2	Destino
M 242-A	4,77	037296	12	360	35 28	242-A



## ▶ MANGO FIBRA CARBONO AZADAS LONGITUD 900

REF.	€	8 41 4299	L mm	Ø1	Ø2	Destino
M 6 CF	33,93	625394	12	900	46 42	Azadas / Picachones
M 7 CF	33,93	625417	12	900	50 45	Azadas / Picachones / Azadones

## MANGOS PARA HORCAS BARNIZADOS



## ▶ MANGO LARGO RECTO HORCA 901

REF.	€	8 41 4299	L mm	Ø1	Ø2	Destino
M 901 LR 120	9,96	156317	12	1.200	28 37	901/903/904/910



## ▶ MANGO LARGO CURVO HORCA 901

REF.	€	8 41 4299	L mm	Ø1	Ø2	Destino
M 901 LC 135	11,67	156324	12	1.350	28 37	901/903/904/910



## ▶ MANGO ANILLA HORCA 901-902

REF.	€	8 41 4299	L mm	Ø1	Ø2	Destino
M 901 AC 75	12,19	156300	12	750	38 37	901/903/904/910



## ▶ MANGO ANILLA HORCA 901-902

REF.	€	8 41 4299	L mm	Ø1	Ø2	Destino
M 902 AC 75	19,58	246971	12	750	38 37	902/911

## MANGOS PARA RASTRILLOS BARNIZADOS



## ▶ MANGO RASTRILLOS 952

REF.	€	8 41 4299	L mm	Ø1	Ø2	Destino
M 952	7,90	157918	12	1.200	18,5 28	950 / 951 / 952
M 952 L	8,89	033106	12	1.500	15 28	950 / 951 / 952

## MANGOS PARA GUADAÑAS



## ▶ MANGO METÁLICO GUADAÑAS 2503

REF.	€	8 41 4299	L mm	Destino
M 2503 R	20,90	541830	6 1.365	2503 / 2506 / 2509
A 2503	7,76	994827	6	2531 / 2532 / 2533

Mango para guadaña y abrazadera para el mango. Ergonomía y durabilidad.

## MANGOS PARA ESCOBAS BARNIZADOS



## ▶ MANGO ESCOBAS 3020

REF.	€	8 41 4299	L mm	Ø1	Ø2	Destino
M 3020	7,86	050608	12 1.200	16 25	Escobas	



## ▶ MANGO ESCOBAS PLÁSTICO 3034

REF.	€	8 41 4299	L mm	Ø1	Ø2	Destino
M 3034	7,86	069327	12 1.400	18 23,5	Escobas de plástico	

## MANGOS PARA HERRAMIENTAS DE MANGO LARGO BARNIZADOS



## ▶ MANGO HERRAMIENTA JARDÍN MANGO LARGO 3080

REF.	€	8 41 4299	L mm	Ø1	Ø2	Destino
M 3080	7,86	216646	6 1.500	13 30	Htas. mango largo jardín	

## MANGOS PARA MAZA-CUÑA BARNIZADOS



▶ MANGO MAZA-CUÑA 5460

REF.	€	8 41 4299	L mm	Ø1	Ø2	Destino
M 5460-3	13,80	149951	12	890		5460-3

## MANGOS PARA GAMA FITO 0% BARNIZADOS



▶ MANGO LARGO HERRAMIENTA FITO 0% LHT3085

REF.	€	8 41 4299	L mm	Ø1	Ø2	Destino
M3085	9,01	706291	12	820	1.500	LHT3085/LHT308610/ LHT308612
M3087	9,01	705713	12	890	1.500	LHT3087

## MANGOS PARA PALAS Y PALOTES BARNIZADOS



▶ MANGO ANILLA PALA ALUMINIO 5520

REF.	€	8 41 4299	L mm	Ø1	Ø2	Destino
M 5520 A	15,38	158250	12	865	29	5520/5522



▶ MANGO LARGO PALA ALUMINIO 5520

REF.	€	8 41 4299	L mm	Ø1	Ø2	Destino
M 5520 L	14,83	157505	12	1.200	24	5520/5522



▶ MANGO ANILLA PALA ALUMINIO 5525

REF.	€	8 41 4299	L mm	Ø1	Ø2	Destino
M 5525 A	15,21	422252	12	610	25	5525



▶ MANGO MULETA PARA PALOTES

REF.	€	8 41 4299	L mm	Ø1	Ø2	Destino
M 5604 M	11,90	150322	12	700	23,5	5604
M 5573 M	11,67	641677	12	700	26,9	5573



▶ MANGO ANILLA PARA PALOTES

REF.	€	8 41 4299	L mm	Ø1	Ø2	Destino
M 5604 A	13,80	150346	12	700	23,5	5604
M 5573 A	13,55	641639	12	700	26,9	5573



▶ MANGO LARGO PARA PALA 5609

REF.	€	8 41 4299	L mm	Ø1	Ø2	Destino
M 5609 L	8,87	069914	12	985	22	5609

## MANGOS PARA HACHAS BARNIZADOS



▶ MANGO HACHA 8131

REF.	€	8 41 4299	L mm	Ø1 A	Ø1 L	Ø2 A	Ø2 L	Destino	
M 8131-300	6,65	930832	12	480	23,5	44	19	39	8131



▶ MANGO HACHA 8130 C

REF.	€	8 41 4299	L mm	Ø1 A	Ø1 L	Ø2 A	Ø2 L	Destino	
M 8130-300 C	5,69	708172	12	380				8130-300N/8130-400N	
M 8130-500 C	6,37	708196	12	400				8130-500 N	
M 8130-600 C	6,46	708219	12	420				8130-600 N	
M 8130-700 C	6,83	708233	12	450				8130-700N/8130-800N	
M 8130-1000	11,75	708714	12	600	31	55	26	46	8130-1000/8130-1000N
M 8130-1200	13,17	708738	12	700	32	57	27	52	8130-1200/8130-1200N
M 8130-1500	14,68	708752	6	800	34	60	28	54	8130-1500/8130-1500N
M 8130-2000	15,73	708776	6	800	36	63	29	57	8130-2000/8130-2000N

## MANGOS PARA RASPAS BARNIZADOS



▶ MANGO RASPA 4090

REF.	€	8 41 4299	L mm	Destino	
4090-7	6,12	184341	24	100	Limas

## MANGOS PARA AZADAS SIN BARNIZAR

- Línea económica que proviene de los rechazos de nuestra gama premium.
- Pueden tener nudos, pequeñas grietas, grietas rellenas con masilla y pequeñas faltas de material (estos defectos no afectan a la funcionalidad de la herramienta).
- Diseño ergonómico adaptado a la geometría de cada herramienta.
- Mangos ligeros.

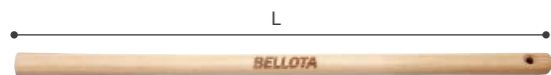

► MANGO SIN BARNIZAR AZADAS LONGITUD 600

REF.	€	8 41 4299	L mm	Ø1	Ø2	Destino
M 1-600 SB	2,73	606164	36	600	32 30	



► MANGO SIN BARNIZAR AZADAS LONGITUD 900

REF.	€	8 41 4299	L mm	Ø1	Ø2	Destino
M0-900 SB	4,04	591149	12	900	30 26	Azadas
M1-900 SB	4,23	590104	12	900	32 30	Azadas
M2-900 SB	4,56	591163	12	900	35 32	Azadas
M3-900 SB	4,82	591187	12	900	37,5 34	Azadas
M4-900 SB	4,99	587494	12	900	41 37	Azadas
M5-900 SB	5,43	591200	12	900	43 39	Azadas
M6-900 SB	5,81	590142	12	900	46 42	Azadas / Picachones



► MANGO SIN BARNIZAR AZADAS LONGITUD 1200

REF.	€	8 41 4299	L mm	Ø1	Ø2	Destino
M0-1200 SB	4,82	591224	12	1.200	30 26	Azadas
M1-1200 SB	5,09	591248	12	1.200	32 30	Azadas
M2-1200 SB	5,80	591262	12	1.200	35 32	Azadas
M3-1200 SB	5,68	590999	12	1.200	37,5 34	Azadas
M4-1200 SB	6,67	591286	12	1.200	41 37	Azadas
M5-1200 SB	6,67	590166	12	1.200	43 39	Azadas
M6-1200 SB	7,63	591309	12	1.200	46 42	Azadas / Picachones
M7-1200 SB	9,01	591323	12	1.200	50 45	Azadas / Picachones

## MANGOS PARA ESCOBAS SIN BARNIZAR



► MANGO SIN BARNIZAR ESCOBAS 3020

REF.	€	8 41 4299	L mm	Ø1	Ø2	Destino
M 3020 SB	3,78	591378	12	1.200	16 25	Escobas

## MANGOS PARA PALOTES SIN BARNIZAR



► MANGO ANILLA SIN BARNIZAR PARA PALOTES 5604

REF.	€	8 41 4299	L mm	Ø1	Ø2	Destino
M 5604-A SB	6,85	591477	12	868	23,5 38	5604/5573



► MANGO LARGO SIN BARNIZAR PARA PALOTES 5604

REF.	€	8 41 4299	L mm	Ø1	Ø2	Destino
M 5604-L SB	6,32	591453	12	985	23,5 38	5604/5573

## MANGOS PARA AZADAS

### MANGOS: M 900, M 1200 Y M 1400

REF.	Destino
M0	Azadas: 240, 242-0
M1	Azadas: 1-A, 1-B, 7-A, 182, 228-A, 228-B, 228-C, 228-D, 229-A, 230-A, 230-B, 232-A, 232-B, 232-C, 242-A, 326, 343-B-30, 344-A y 344-B
M2	Azadas: 276 Horquillas: 1020-A
M3	Azadas: 8-A, 8-B, 8-C, 72-A, 72-B, 80-A, 80-B, 81-000, 81-00, 81-0, 82-B, 85-A, 85-B, 85-C, 89-A, 90-B, 91-A y 91-B
M4	Azadas: 1-C, 2-A, 2-B, 3-A, 3-B, 3-C, 4-A, 4-B, 10-A, 53-A, 53-B, 58-0, 58-A, 69-A, 72-C, 72-D, 77-D, 79-C, 80-E, 80-H, 81-A, 81-B, 83-A, 84-A, 84-B, 84-C, 84-E, 87-A, 87-C, 87-D, 87-E, 150-A, 150-C, 302-0, 302-A, 320, 325, 335, 337-0, 337-A, 338-0, 338-A, 340-0, 340-A y 340-B Horquillas: 1001-0, 1001-A y 1018
M5	Azadas: 327 y 328, Horca 912-3
M6	Azadas: 5, 11-A, 69-B, 87-F, 87-G, 95-A, 95-C, 252-0, 252-A, 252-B y 252-C, Horquillas: 1002-A y 1002-B Picachones: 5001-A y 5001-B
M7	Azadas: 43-0 y 43-B, Azadones: 801-0, Picachones: 5001-C y 5001-D, Azadón: 820, Azadones: 805-A

### MANGOS: LIGERAS

REF.	Destino
M1200	Azadas: L1, L3, L5
M500	Azadas: L2, L4

# MANGOS PARA LA CONSTRUCCIÓN

## Mangos de madera

- Fabricados con madera de primera calidad, con las propiedades más adecuadas al trabajo a realizar.
- Diseño ergonómico adaptado a la geometría de cada herramienta.
- Mangos ligeros y agradables al tacto.
- Perfecto acabado barnizado.



### COMPROMISO CON LA CALIDAD Y EL MEDIO AMBIENTE:

Aquellos mangos cuya madera es de haya cuentan con el Certificado PEFC. Este certificado garantiza que el 100% de la madera utilizada proviene de bosques gestionados correctamente según estrictos requisitos sociales, ambientales y económicos aprobados internacionalmente, al mismo tiempo que se optimizan los recursos forestales a lo largo de todo el proceso de fabricación.



Los mangos de jardín cuentan con la Certificación FSC® – Forest Stewardship Council®, que garantiza que la madera utilizada proviene 100% de montes aprovechados de forma responsable, de acuerdo a unos estándares internacionales que contemplan aspectos ambientales, sociales y económicos, y que definen los niveles mínimos de buena gestión para los bosques de todo el mundo.

Consulte nuestras herramientas certificadas.

## Mangos fibra de carbono

- Fabricados con materiales de última generación.
- Diseño ergonómico adaptado a la geometría de cada herramienta: Los discos segmentados proporcionan una mayor velocidad de corte.
  - Formas estudiadas y analizadas según la mano, posición de agarre y uso de cada producto: mayo comodidad, agarre y mejor sensación en la mano.
  - Estrías laterales que refuerzan el efecto antideslizamiento y mejoran el agarre.
  - Fin de carrera diseñado para una mayor sujeción del mango mejorando ergonomía y seguridad.
- Mango irrompible, fabricado en tres materiales diferentes:
  - Núcleo con fibra de carbono para mayor duración y resistencia.
  - Cuerpo de polímero técnico de última generación.
  - Recubrimiento de elastómero TPS para mayor ergonomía.

### Mango ovalado

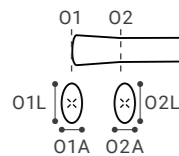

### Mango cónico

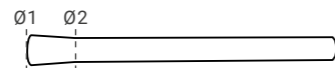

### Mango rectangular

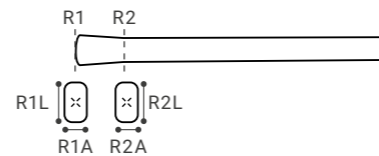

## MANGOS PARA MARTILLERÍA BARNIZADOS



### MANGO FIBRA CARBONO PICACHONES LONGITUD 900

REF.	€	8 41 4299	L mm	Destino
M 6 CF	33,93	625394	12 900	Azadas / Picachones
M 7 CF	33,93	625417	12 900	Azadas / Picachones / Azadones



### MANGO PICACHÓN 5016

REF.	€	8 41 4299	L mm	O1 A	O1 L	O2 A	O2 L	Destino
M 5016-00	12,96	185430	6 900	41	55	35	49	Herr. de mango largo



### MANGO MAZA 5200N

REF.	€	8 41 4299	L mm	Destino
M 5200-2N	8,70	373950	12 600	5200-2
M 5200-3N	8,70	373998	12 600	5200-3
M 5200-4N	11,59	374049	12 700	5200-4
M 5200-5N	12,35	374117	12 800	5200-5
M 5200-6N	12,35	374155	12 800	5200-6

\*Junto con el mango recibirás también las cuñas.



### MANGO MAZA 5200

REF.	€	8 41 4299	L mm	Destino
M 5200-2	8,70	149401	12 600	5203-2
M 5200-3	8,45	075748	12 600	5203-3
M 5200-4	11,23	149500	12 700	5203-4
M 5200-5	11,99	075779	12 800	5203-5
M 5200-6	12,35	075809	12 800	5203-6
M 5200-8	13,55	075830	12 900	5200-8

\*Junto con el mango recibirás también las cuñas.



### MANGO FIBRA CARBONO MAZA 5200

REF.	€	8 41 4299	L mm	O1 A	O1 L	O2 A	O2 L	Destino
M 5200-4 CF	33,93	625455	12 700	33,4	49,9	29,2	45,7	5200-3/5200-4
M 5200-6 CF	39,84	625479	12 900	33,4	49,9	29,2	45,7	5200-5/5200-6/5460-3CF



### MANGO MACETA 5308N

REF.	€	8 41 4299	L mm	O1 A	O1 L	O2 A	O2 L	Destino
M 5308-0 N	3,87	626773	12 280	25	38	31	40	5308-0 N
M 5308-A N	3,76	353242	12 280	25	38	31	40	5308-A N
								5308-B N

\*Junto con el mango recibirás también las cuñas.



### MANGO FIBRA DE CARBONO MACETA 5308N-5310

REF.	€	8 41 4299	L mm	O1 A	O1 L	O2 A	O2 L	Destino
M 5308 CF	15,44	625431	12 270	26,8	40	26	39,5	5308

Mangos fibra de carbono para macetas 5308 y 5310.



### MANGO MACETA 5305

REF.	€	8 41 4299	L mm	Destino
M 5305	4,99	149609	12 235	5305-0 / 5305-A

\*Junto con el mango recibirás también las cuñas.



### MANGO MACETA 5308

REF.	€	8 41 4299	L mm	Destino
M 5308-0	3,54	149708	12 280	5308-0
M 5308-A	3,76	149807	12 280	5308-A
M 5308-B	3,76	149906	12 280	5308-B

\*Junto con el mango recibirás también las cuñas.



### MANGO MACETA M 5310

REF.	€	8 41 4299	L mm	Destino
M 5310-A	3,87	626797	12 260	5310-A / 5310-B
M 5310-C	3,87	626810	12 260	5310-C / 5310-D



### MANGO MACETA 5312

REF.	€	8 41 4299	L mm	Ø1	Ø2	Destino
M 5312	5,25	040449	12 400	39	33	5312-400



### MANGO ALCOTANA 5938

REF.	€	8 41 4299	L mm	Destino
M 5938	5,53	205268	12 386	5938

\*Junto con el mango recibirás también las cuñas.



### MANGO ALCOTANA 5931N-5932N-5933N

REF.	€	8 41 4299	L mm	Destino
M 5931-0 N	3,87	635560	12 310	5931 AN/5932 -AN/ 5933- AN
M 5931-A N	4,06	635584	12 310	5931 AN/5932 -AN/ 5933- AN
M 5931-B N	4,28	635607	12 335	5931-BN/5932 BN

\*Junto con el mango recibirás también las cuñas.



### MANGO MARTILLO AMERICANO 8002

REF.	€	8 41 4299	L mm	Destino
M 8002-13	3,99	611977	12 300	8002-13
M 8002-16	4,34	611991	12 325	8002-16
M 8002-20	5,18	612011	12 325	8002-20
M 8002-24	5,18	612035	12 345	8002-24

\*Junto con el mango recibirás también las cuñas.



MANGO MARTILLO NARANJERO 8004

REF.	€	8 41 4299	L mm	Destino
M 8004-A	4,34	111118	12 325	8004 A



MANGO MARTILLO EBANISTA 8005

REF.	€	8 41 4299	L mm	Destino
M 8005-16	3,15	151800	12 259	8005-16
M 8005-A	3,38	151107	12 269	8005-A
M 8005-B	3,38	151206	12 279	8005-B
M 8005-C	3,75	151305	12 289	8005-C
M 8005-D	3,75	151404	12 304	8005-D
M 8005-E	3,75	151503	12 319	8005-E
M 8005-F	3,83	151602	12 334	8005-F

\*Junto con el mango recibirás también las cuñas.



MANGO MARTILLO 8007 Y ALCOTANAS

REF.	€	8 41 4299	L mm	Ø1	Ø2	Destino
M 8007-A	2,91	151909	12 300	25,5	22	8007-A
M 8007-B	3,27	152005	12 300	26,6	23	8007-B / 5931-0 5932-00 / 5932-0 5933-00 / 5933-0
M 8007-C	3,27	152104	12 335	27,8	24	8007-C / 5931-A 5932-A / 5933-A
M 8007-D	3,47	152203	12 335	29	25	8007-D / 5931-B 5932-B / 242-A
M 8007-E	3,87	152302	12 360	30	26	8007-E
M 8007-F	3,99	152401	12 360	31,2	27	8007-F



MANGO MARTILLO HACHA 8008

REF.	€	8 41 4299	L mm	Destino
M 8008	4,39	035810	12 375	8008

\*Junto con el mango recibirás también las cuñas.



MANGO MARTILLO MECÁNICO 8009-8011

REF.	€	8 41 4299	L mm	Destino
M 8011-A	4,19	152500	12 300	8011-A
M 8011-B	4,19	152609	12 310	8011-B / 8009-A
M 8011-C	4,15	152708	12 320	8011-C / 8009-B
M 8011-D	4,21	152807	12 330	8011-D / 8009-C
M 8011-E	4,73	152906	12 345	8011-E / 8009-D
M 8011-F	4,73	153002	12 360	8011-F / 8009-E
M 8011-G	5,23	153101	12 380	8011-G
M 8011-H	5,23	153200	12 400	8011-H

\*Junto con el mango recibirás también las cuñas.



MANGO MARTILLO ENCOFRADOR 8017

REF.	€	8 41 4299	L mm	Ø1 A	Ø1 L	Ø2 A	Ø2 L	Destino
M 8017-0**	4,72	487152	12 400	29	41	20,2	32,2	5936-A 300 / 5936-B 400 8017-0 / 8017-A
M 8017-A	4,73	153705	12 450	29	41	20,2	32,2	5935-A 400 / 5935-B 600 5936-C 500 / 5937-A 400
M 8017-B	4,88	153804	12 450	31	43	21,9	33,9	8017-B
M 8017-C	5,45	153903	12 450	33	45	23,5	35,5	8017-C
M 8017-D	5,45	154009	12 450	35	47	25	37	8017-D

\* Junto con el mango recibirás también las cuñas.

\*\* HASTA FIN DE EXISTENCIAS.



MANGO MARTILLO ENCOFRADOR 8030

REF.	€	8 41 4299	L mm	Ø1 A	Ø1 L	Ø2 A	Ø2 L	Destino
M 8030	5,52	469905	12 450	27,5	40	23	34,5	8030



MANGO FIBRA CARBONO MARTILLO ENCOFRADOR 8030

REF.	€	8 41 4299	L mm	Ø1 A	Ø1 L	Ø2 A	Ø2 L	Destino
M 8030 CF	15,09	636703	12 500	26,4	38,4	24,8	36,8	8030



MANGO MARTILLO BOCAS NYLON 8050

REF.	€	8 41 4299	L mm	Destino
M 8050-25	5,52	584622	12 254	8050-25
M 8050-32	6,07	586725	12 279	8050-35
M 8050-38	6,53	589061	12 284	8050-38
M 8050-44	6,92	590746	12 305	8050-44
M 8050-50	9,47	593327	12 335	8050-50

\*Junto con el mango recibirás también las cuñas.



MANGO MACETA GOMA 8053

REF.	€	8 41 4299	L mm	Ø1 A	Ø1 L	Ø2 A	Ø2 L	Destino
M 8053-250	6,24	446753	12 320	27	31	23	27	8053-250
M 8053-500	6,38	447064	12 340	32	38	27,3	33,2	8053-500
M 8053-750	6,57	447286	12 380	32	38	26,7	32,7	8053-750

## MANGOS PARA PALAS BARNIZADOS



MANGO MULETA PALA 5501-5502

REF.	€	8 41 4299	L mm	Destino
M 5501 M	9,19	150001	12 700	5501 / 5502



MANGO ANILLA PALA 5501-5502

REF.	€	8 41 4299	L mm	Destino
M 5501 A	13,02	150100	12 700	5501 / 5502



MANGO LARGO PALA 5501-5502

REF.	€	8 41 4299	L mm	Destino
M 5501 L	13,94	150209	12 985	5501 / 5502



MANGO LARGO PALA 5559

REF.	€	8 41 4299	L mm	Ø1	Ø2	Destino
M 5559 L	14,83	792140	6 1.320	34	27	5559

## MANGOS PARA RAEDERAS BARNIZADOS



MANGO RAEDERA 5701

REF.	€	8 41 4299	L mm	Destino
M 5701 L	8,92	792942	12 985	5701/5709/5710
M 5701 L 120	10,25	907520	12 1.200	5701/5709/5710

Mango para rascador 5710.



NEW

MANGO M4 CON SISTEMA ANTIGIRO

REF.	€	8 41 4299	L mm	Ø1	Ø2	Destino
HDLM4W1000APH	11,53	697636	12 1.000	41,5	33	5702A/PRK5753BP
HDLM4W1200APH	15,94	697650	12 1.200	41,5	33	5702A/PRK5753BP
HDLM4W1400APH	17,59	697674	12 1.400	41,5	33	5702A/PRK5753BP

## MANGOS PARA PALETAS BARNIZADOS



MANGO PALETAS Y PALETINES 5842

REF.	€	8 41 4299	L mm	Destino
M 5842-D	1,50	150407	24 100	Paletines
M 5842-H	1,59	150506	24 100	Paletas



NEW

MANGO PALETAS HDL01BWPB

REF.	€	8 41 4299	L mm	Destino
HDL01BWPB	3,09	690576	24 100	Paletas



## MANGOS PARA PALAS SIN BARNIZAR



▶ MANGO SIN BARNIZAR MULETA PALA 5501-5502

REF.	€	8 41 4299	12	L mm	Destino
M 5501 MSB	3,97	591514	12	700	5501-5502



▶ MANGO SIN BARNIZAR CURVO PALA 5556

REF.	€	8 41 4299	12	L mm	Destino
M 5556-2 C SB	6,11	590203	12	1.170	5556-2



▶ MANGO SIN BARNIZAR RECTO PALA 5556

REF.	€	8 41 4299	12	L mm	Destino
M 5556-2 R SB	4,86	590180	12	1.170	5556-2



▶ MANGO LARGO PALA RECTO SIN BARNIZAR 108

REF.	€	8 41 4299	12	L mm	Destino
MF108SBG	6,33	590180	12	1.170	108

## MANGOS PARA RAEDERAS SIN BARNIZAR



▶ MANGO RAEDERA 5701

REF.	€	8 41 4299	12	L mm	Destino
M 5701 L SB	4,29	792942	12	985	5701/5709/5710
M 5701 L 120 SB	4,91	907520	12	1.200	5701/5709/5710

Mango para rascador 5710.



▶ MANGO ALCOTANA 5938

REF.	€	8 41 4299	12	L mm	Ø1	Ø2	Destino
M 5938 SB	2,12	205268	12	386	36	32	5938

## CUÑAS PARA MANGOS DE MADERA

- Cuña de fibra de vidrio PATENTADA que asegura una perfecta unión mango y cabeza.
- Mayor seguridad: mejora la unión entre mango y cabeza.
- Unión extra fuerte: incrementa la fuerza necesaria de tracción.
- Excelente resistencia: su fibra de vidrio y poliamida proporcionan una elevada resistencia a la corrosión, intemperie y temperatura.



▶ BLISTER 6 CUÑAS PARA MAZAS Y MACETAS

REF.	€	8 41 4299	50
8975 BL	6,11	572643	50

## CONTENIDO 8975 BL

REF.	UDS.	
Cuña Nº 7	3	5200-2, 5308-AN, 5308-BN, 8130-300/400/500
Cuña Nº 8	3	5200-3, 5200-4, 5200-5, 5200-6, 5200-8, 8130-600/700/800



▶ BLISTER 6 CUÑAS PARA MACETAS Y MARTILLOS

REF.	€	8 41 4299	50
8976 BL	4,31	572667	50

## CONTENIDO 8976 BL

REF.	UDS.	
Cuña Nº 1	1	8005-16, 8005-A, 8005-B, 8011-A
Cuña Nº 2	2	8002-13, 8005-C, 8005-D, 8009-A, 8011-B
Cuña Nº 3	1	8002-16, 8004-A, 8005-E, 8005-F, 8009-B, 8009-C, 8011-C, 8011-D
Cuña Nº 4	1	5308-0, 8009-D, 8009-E, 8011-E, 8011-F
Cuña Nº 6	1	8002-20, 8002-24, 8011-G, 8011-H

## MANGOS PARA EL TALLER

## MANGOS PARA LIMAS



▶ MANGO PLÁSTICO LIMAS 4089

REF.	€	8 41 4299	24	L mm	Destino
4089-1	1,74	465204	24	92	Limas
4089-2	2,02	465303	24	92	Limas
4089-3	2,02	465402	24	105	Limas
4089-4	2,26	465501	24	105	Limas
4089-7	2,78	096897	24	105	Limas



▶ MANGO BIMATERIAL LIMAS 4093

REF.	€	8 41 4299	24	L mm	Destino
4093-A1	4,05	108736	24	120	Limas
4093-A2	4,05	109634	24	120	Limas
4093-A3	4,05	109696	24	120	Limas
4093-A4	3,91	109849	24	120	Limas
4093-B1	4,05	138764	24	120	Limas
4093-B2	4,05	138870	24	120	Limas
4093-B3	4,05	138931	24	120	Limas
4093-B4	3,91	138979	24	120	Limas
4093-B5	4,05	139037	24	120	Limas



▶ MANGO LIMAS 4090

REF.	€	8 41 4299	24	L mm	Destino
4090-2	1,54	465709	24	85	Limas
4090-3	1,78	465808	24	95	Limas
4090-4	1,79	465907	24	108	Limas
4090-5	1,99	466003	24	120	Limas
4090-6	2,02	466102	24	133	Limas

## MANGO PLÁSTICO 4089

REF.	
4089-1	4004-4 / 4006-4 / 4040-5 / 4041-4 / 4041-4,5 / 4042-3
4089-2	4001-4 / 4002-4 / 4003-4 / 4004-6 / 4005-4 / 4006-6 / 4040-6 / 4041-5 / 4041-6 / 4042-4 / 4081-4 / 4104-6
4089-3	4004-8 / 4005-6 / 4006-8 / 4041-7 / 4041-8 / 4042-5 / 4042-6 / 4042-7 / 4081-5 / 4104-8
4089-4	4001-6 / 4002-6 / 4003-6 / 4004-10 / 4004-12 / 4005-8 / 4006-10 / 4006-12 / 4007-6 / 4008-6 / 4042-8 / 4042-9 / 4081-6 / 4081-7 / 4081-8 / 4087-6 / 4101-6 / 4101-8 / 4102-6 / 4102-8 / 4104-10
4089-7	4001-8 / 4002-8 / 4003-8 / 4005-10 / 4008-8 / 4008-10 / 4042-10 / 4081-10 / 4101-10 / 4102-10 / 4103-8

## MANGO DE MADERA 4090

REF.	
4090-2	4001-4 / 4002-4 / 4003-4 / 4004-6 / 4006-6 / 4040-5 / 4041-5 / 4042-5 / 4081-5 / 4104-6
4090-3	4001-6 / 4002-6 / 4003-6 / 4004-8 / 4005-6 / 4006-8 / 4007-6 / 4008-6 / 4040-6 / 4041-6 / 4042-6 / 4081-6 / 4087-6 / 4101-6 / 4102-6 / 4104-8
4090-4	4001-8 / 4002-8 / 4003-8 / 4004-10 / 4004-12 / 4005-8 / 4006-10 / 4006-12 / 4008-8 / 4041-7 / 4041-8 / 4042-7 / 4042-8 / 4081-7 / 4081-8 / 4101-8 / 4102-8 / 4103-8
4090-5	4001-10/4002-10/4003-10/ 4005-10 / 4008-10 / 4042-9 / 4042-10/4081-10/4101-10/ 4102-10 / 4104-10
4090-6	4001-12 / 4001-14 / 4002-12 / 4002-14 / 4003-12 / 4003-14 / 4005-12 / 4101-12

## MANGO DE MADERA 4090-7

REF.	
4090-7	4132-14

## MANGO BIMATERIAL 4093

REF.	
4093-A1	4001-14 / 4002-14 / 4003-14
4093-A2	4003/4001-10 / 4001-12 / 4002-10 / 4002-12 / 4003-12 / 4101-12
4093-A3	4003-10 / 4008-10 / 4101-10 / 4102-10
4093-A4	4001-8 / 4002-8 / 4003-8 / 4008-8 / 4101-8 / 4102-8 / 4103-8
4089-7	4001-8 / 4002-8 / 4003-8 / 4008-8 / 4101-8 / 4102-8 / 4103-8
4093-B1	4005-10 / 4005-12 / 4042-10 / 4081-10
4093-B2	4004-12 / 4005-8 / 4006-12 / 4041-8 / 4042-8 / 4042-9 / 4081-8
4093-B3	4001-6 / 4002-6 / 4003-6 / 4004-10 / 4005-6 / 4006-10 / 4007-6 / 4008-6 / 4041-6 / 4041-7 / 4042-5 / 4042-6 / 4042-7 / 4081-5 / 4081-6 / 4081-7 / 4087-6 / 4101-6 / 4102-6 / 4104-10
4093-B4	4001-4 / 4002-4 / 4003-4 / 4004-6 / 4004-8 / 4005-4 / 4006-6 / 4006-8 / 4040-6 / 4042-4 / 4081-4 / 4104-6 / 4050
4093-B5	4104-8 / 004-4 / 4006-4 / 4040-5 / 4041-4 / 4041-4,5 / 4041-5 / 4042-3

# SOLUCIONES PARA EL PUNTO DE VENTA

Bellota ofrece soluciones para una óptima presentación de la herramienta en el punto de venta.



REF.	€	8 41 4299	g	A mm	B mm	C mm
8990EN	794,50	704730	1	4.500	450	1.000 2.570



REF.	€	8 41 4299	g	A mm	B mm	C mm
3955	349,00	622416	1	16.000	410	2.100 830



REF.	€	8 41 4299	g	A mm	B mm	C mm
EXPCORT	394,95	053609	1	29.000	1.050	780 1.100

NEW



REF.	€	8 41 4299	g	A mm	B mm	C mm
EXPMEZ	194,95	014150	1	8.500	390	780 300

NEW



REF.	€	8 41 4299	g	A mm	B mm	C mm
8940V	371,93	627091	1	18.250	38	79 90



REF.	€	8 41 4299	g	A mm	B mm	C mm
8942V	167,35	698893	1	13.000	380	280 1.000



REF.	€	8 41 4299	g	A mm	B mm	C mm
8970 V	110,81	926699	1	9.800	470	400 760



REF.	€	8 41 4299	g	A mm	B mm	C mm
8944V	501,97	697407	1	0		



REF.	€	8 41 4299	g	A mm	B mm	C mm
8943V	108,80	698886	1	4.000	450	250 400



REF.	€	8 41 4299	g	A mm	B mm	C mm
8952 V	74,95	926613	1	3.830	420	220 105



EXPOSITOR CALZADO

REF.	€	8 41 4299	g	A mm	B mm	C mm
72294N	410,55	705560	1	4.000	1.790	575 280



EXPOSITOR AZADAS

REF.	€	8 41 4299	A mm	B mm	C mm
HOEXP	255,00	710984	1	650	380 140

\* VÁLIDO PARA EL MERCADO ESPAÑOL.



ACCESORIOS PARA EXPOSITOR 899E

REF.	€	8 41 4299	A mm	B mm	C mm
8990PUAN	4,64	704785	1	8990E	
8990PALETAN	17,42	704822	1	8990E	
8990CPOP	41,01	704846	1	8990E	
8990CPRON	31,88	704860	1	8990E	
8990CALZADON	12,23	704808	1	8990E	
8990DUON	6,12	015904	1	8990E	
8990ESTAN	71,40	016420	1	8990E	

ACCESORIOS PARA EXPOSITOR

REF.	€	8 41 4299	A mm	B mm	C mm
5840C	0,74	621754	1		
6485G	0,65	601633	1		
6485P	0,57	601640	1		
50014HANGER	0,39	709889	1		



# CONDICIONES GENERALES DE VENTA

## PRECIOS

Los precios de esta Tarifa son precios P.V.P. recomendados, incluyendo en el mismo el embalaje standard, y debiendo añadirse los impuestos y tasas correspondientes. Los precios de esta Tarifa no incorporan el Impuesto sobre el Valor Añadido, I.V.A., ni otros impuestos que puedan gravar la operación.

## MODIFICACIÓN DE PRECIOS

En caso de modificación de precios se aplicarán los precios vigentes en la fecha de la expedición.

## PEDIDOS

Los pedidos no se considerarán en firme mientras no hayan sido expresamente confirmados por escrito por Bellota Herramientas S.L.U.

## PEDIDO MÍNIMO Y PORTES

Pedidos cuya cuantía neta esté entre 0€-100€: tarifa neta de 17€ por gastos de gestión y portes.

Pedidos cuya cuantía neta esté entre 100€-300€: tarifa neta de 10€ por gastos de gestión y portes.

## PLAZOS DE ENTREGA

Las mercancías serán entregadas dentro de un plazo razonable a partir de la confirmación del pedido. Los plazos de entrega que se indiquen al cliente tendrán carácter puramente informativo, no siendo vinculante para Bellota Herramientas S.L.U.

## MEDIO DE TRANSPORTE

Salvo acuerdo expreso, la elección del medio de transporte será realizada por Bellota Herramientas, S.L.U.

## ENVÍOS URGENTES

Se cursará el pedido urgente por teléfono antes de las 12:00 horas, con un máximo de 10 líneas de pedido y ajustando las cantidades al envase mínimo. Los portes por transporte y gestión serán de 20€.

## EXPEDICIONES

La parte compradora comprobará la correcta recepción de la mercancía. En caso de detectar cualquier tipo de incidencia deberá comunicarlo en un plazo máximo de 24 h. Superado este plazo, Bellota Herramientas, S.L.U. no se hará responsable de cualquier no conformidad relacionada con el transporte.

## PAGO DE LAS FACTURAS

Primer pedido mediante pago anticipado y posteriores con Giro a 60 días de la fecha factura, neto.

## FACTURACIÓN

Sólo se considerarán compras los pedidos que sean facturados, considerándose sin efecto los pedidos pendientes de servir al finalizar el año.

## GARANTÍAS

Bellota Herramientas, S.L.U. ofrece garantía de fabricación de sus productos a partir de la fecha de entrega. Para que el comprador pueda hacer valer sus derechos de garantía, se requerirá que informe de los defectos del mismo en el plazo máximo de 15 días desde que los mismos se pongan de manifiesto.

La garantía no cubre el desgaste natural ni los daños originados posteriormente a la entrega de las mercancías cuando resulte de la manipulación o manejo erróneo o descuido de las mercancías, a su almacenamiento incorrecto, o a trabajos de reparación inadecuados realizados por el comprador o terceros.

Para exigir la garantía, el comprador deberá estar el corriente en el cumplimiento de sus obligaciones contractuales, en particular de sus obligaciones de pago. El comprador se compromete a informar con carácter urgente de cualquier reclamación que reciba de sus clientes y/o terceros en relación a posibles defectos de los productos suministrados.

## TÉRMINOS GENERALES

Las condiciones generales de venta establecidas por Bellota Herramientas, S.L.U. son las únicas aplicables. Las condiciones de compra establecidas por los clientes en sus pedidos que se hallen en contradicción con estas condiciones generales de venta sólo serán válidas cuando la parte vendedora las haya aceptado expresamente por escrito.

## RESERVA DE DOMINIO

Todas las mercancías objeto de suministro serán propiedad de Bellota Herramientas, S.L.U. hasta el total pago del precio de la compraventa. Efectuados todos los pagos, el Proveedor transmitirá el dominio de la misma al Cliente.

## JURISDICCIÓN

Las discrepancias entre las partes en relación a la interpretación y/o cumplimiento del contrato se someten a la jurisdicción de los Juzgados y Tribunales de San Sebastián (Guipúzcoa-España) con renuncia expresa a cualquier otro que pudiera corresponderles, siendo aplicable el Derecho Español.

## Notas:

### CÓDIGO DE BARRAS

Para completar la referencia del código de barras, hay que anteponer a los números que vienen en la columna correspondiente a este símbolo la cifra siguiente: 8414299.

Esta tarifa de precios sustituye a la del 2023.  
Esta tarifa entra en vigor el 15/01/2024.



BELLOTA HERRAMIENTAS, S.L.U.  
C/. UROLA Nº 10. APTDO. Nº 1. 20230 LEGAZPI.  
GUIPUZKOA. ESPAÑA





C/ Urola , 10.  
20230. Legazpi.  
Guipúzcoa. España.

T. (+34) 943 73 90 00  
F. (+34) 943 73 15 01

[www.bellota.com](http://www.bellota.com)